



Hinose Hooks®

 广 濑 梭 头

From the library of: YSM Japan

INDEX

索引

	PAGE 页
■ ITEM LIST & PHOTOS 分类与图片	1~55
HORIZONTAL AXIS ROTARY HOOK (DB TYPE) 垂直回转式梭头 (DB 型)	
HIGH SPEED TYPE 高速缝梭头	3
LARGE TYPE 大型梭头	7
LOW SPEED TYPE 低速缝梭头	9
HORIZONTAL AXIS ROTARY HOOK (DP TYPE) 垂直回转式梭头 (DP 型)	
HIGH SPEED ZIGZAG TYPE 高速人字型缝梭头	12
VERTICAL AXIS ROTARY HOOK 水平回转式梭头	
STANDARD TYPE with SHANK 短轴小型梭头	14
STANDARD TYPE with SHAFT 长轴小型梭头	16
STANDARD TYPE with BOSS (HUB) 轴套小型梭头	19
LARGE TYPE with SHANK 短轴大型梭头	20
LARGE TYPE with SHAFT 长轴大型梭头	21
SHUTTLE 摆梭	24
OTHERS 其他	25
BOBBIN CASE / CAP 梭芯套/梭帽	26
■ REFERENCE TABLE 梭头与机种对照表	57~112
■ USER'S GUIDANCE 使用说明	113~117
■ COMPONENT PARTS 各零件的名称	118
■ HIROSE INNOVATIONS 广濑独创的产品	
OIL-FREE HOOK 无需注油梭头	119
HTH-SERIES HOOK SETS HTH 系列梭头	120
HTM-SERIES HOOK SETS HTM 系列梭头	121
SUPER HARD POINT HOOK 硬尖梭头	122

ITEM LIST & PHOTOS

分类与图片

HORIZONTAL AXIS ROTARY HOOK (DB TYPE) 垂直回转式梭头 (DB型)

HIGH SPEED TYPE 高速缝梭头

ITEM 广濑品名	APPLICATION 对应機種		NEEDLE SLOT 落针孔		PHOTO PAGE 图片
	BRAND 品牌	MODEL 机型	a	b	
HAD-396	DURKOPP/ADLER	296,396	9.5	1.6	31
HAD-396(H)	DURKOPP/ADLER	396	9.5	1.6	31
HDU-211	DURKOPP/ADLER	211,212,213	8.0	1.6	31
HDU-211(1)	DURKOPP/ADLER	211,261	12.0	1.6	31
HDU-271	DURKOPP/ADLER	271	10.0	1.5	31
※ HDU-271(QRP)	DURKOPP/ADLER	271 RP-series oil free hook	10.0	1.65	31
HDU-272	DURKOPP/ADLER	272	12.0	1.5	31
HNE-830	NECCHI	802,812,830	6.8	1.6	31
HNE-835	NECCHI	832,835,881	9.5	1.6	31
HPF-480	PFAFF	481~489,461-900~469-900 481-900~489-900	10.0	1.7	31
HSH-7.24BJ	JUKI	DDL-105	6.8	1.9	31
HSH-7.24BJZ	JUKI	LZ-586	10.0	1.5	31
HSH-7.94A	JANOME	DB-J705,DB-J706	6.8	1.9	31
	SINGER	400W/402W/451K			
	TYPICAL BROTHER	DB2-C101-6,DB2-C101-7			
	CHUAN NENG	CN-990-5,CN-990-7			
	SIRUBA	L818F-H1,L819-X1			
HSH-7.94A(3)	MITSUBISHI	DY-350-12,LS2-130-HOB,LS2-1130-HOB	6.8	1.9	31
	UNICORN	DB2-H311/H510H/H515H			
HSH-7.94A(TS)		with teflon coated base	6.8	1.9	31
HSH-7.94A1		for extra heavy materials	6.8	2.3	31
HSH-7.94AO		full automatic open type lubricating system	6.8	1.9	31
HSH-7.94AOTR		full automatic open type lubricating system for under trimming machine	6.8	1.9	31
HSH-7.94ATR	CHUAN NENG	CN-991-5,CN-991-7,CN-992-5	10.0	1.9	31
	SIRUBA	L818F-H1-□,L819-X1-U			
HSH-7.94B	JANOME	DB-J701,DB-J704,DB-J708	6.8	1.9	31
	JUKI	DDL-5550,DDL-5530N,DLD-5430 DLD-5430N,DLM-5200N,DLU-5490N			
	MITSUBISHI	LS2-150-MOB,LS2-1130-MOB			
	SINGER	191D300AA,400W/402W/451K,600W			
	TOYOTA	AD150,AD156			
	GEMSY	7-18,7080,8500			
	HIGHLEAD	GC128-M,GC188-M,GC6-28			
	JACK	JK8500			
	PROTEX	TY2000,TY6180M,GC5550			
	SHANGGONG	8800,GC5550,GC30-1			
	TYPICAL	GC6-1,GC6-28,GC69-1			
	WANPING	GC203			
	ZOJE	GC90-1,ZJ999,ZJ8500N			
	SUNSTAR	KM-123A			
	UNICORN	DB2-H310/H510/H515			
	CHUAN NENG	CN-990-3			
KINGTEX	KL-300H,KL-300M,KL-500M				
SIRUBA	L818F-K1,L818F-L1,L818F-M1				
HSH-7.94B(1)		for synthetic & silk thread	6.8	1.9	31
HSH-7.94B(1)TR		for synthetic & silk thread	10.0	1.9	31

HORIZONTAL AXIS ROTARY HOOK (DB TYPE) 垂直回转式梭头 (DB型)

HIGH SPEED TYPE 高速缝梭头

ITEM 广濑品名	APPLICATION 对应機種		NEEDLE SLOT 落针孔		PHOTO PAGE 图片
	BRAND 品牌	MODEL 机型	a	b	
※ HSH-7.94B(2SPH)	JUKI	DDL-5530H, DDL-5550H	10.0	1.9	31
HSH-7.94B(391)	SINGER	281,391U	6.8	1.82	31
HSH-7.94B(491)	SINGER	491, 491UX330, 591D	6.8	1.82	31
HSH-7.94B(660)	SINGER	660	6.8	1.9	31
HSH-7.94B(7)	SINGER	770	8.0	1.85	31
HSH-7.94B(AC)	SINGER	281 air cooled hook	6.8	1.65	31
HSH-7.94B(HP)		super hard point hook	6.8	1.9	32
HSH-7.94B(K)		for heavy materials, sports shoes & bag	6.8	1.6	32
HSH-7.94B(KSN)	SINGER	591C200,591D308AD/AF	10.0	1.65	32
HSH-7.94B(NK)		with 3 hook setting screws	6.8	1.9	32
HSH-7.94B(Q)	TOYOTA	D1412-41, D1512-41	6.8	1.6	32
HSH-7.94B(RT)	BROTHER	DB2-B736-1,DB2-B773,DB2-B777A	6.8	1.6	32
	TYPICAL BROTHER	DB2-C101-3			
	UNICORN	LS2-H530			
HSH-7.94B(SPH)	JUKI	DDL-5530H	10.0	1.9	32
HSH-7.94B(SPHA)		for light materials,handkerchieves	6.8	1.9	32
HSH-7.94B(TS)		with teflon coated base	6.8	1.9	32
HSH-7.94B1		for extra heavy materials	6.8	2.3	32
HSH-7.94BKTR		for heavy materials, sports shoes & bag	10.0	1.9	32
HSH-7.94BKTR(2)	JUKI	DLN-5410NH-7	10.0	1.9	32
HSH-7.94BKTR(H)		for heavy materials, sports shoes & bag	6.8	1.65	32
HSH-7.94BN	SINGER	281,400W/402W/451K	6.8	1.9	32
HSH-7.94BO		full automatic open type lubricating system with 3 hook setting screws	6.8	1.9	32
HSH-7.94BOH	JACK	JK8500H	6.8	1.6	32
	PROTEX	TY1130H,TY2000-5,TY2000-6			
	SHANGGONG	GC15-3,GC15-4			
	ZOJE	GC80-5,GC5580-5,ZJ8500-5			
	SUNSTAR	KM-123B			
HSH-7.94BOH(1)	BROTHER	DB2-B736-5,SL-1010-5	6.8	1.9	32
	TYPICAL	GC6100HD			
	TYPICAL BROTHER	DB2-C101-5			
HSH-7.94BOHN	JUKI	DLN-415H	10.0	1.6	32
HSH-7.94BOHN(1)	JUKI	DLN-415L	10.0	1.6	32
	SUNSTAR	KM-350B			
HSH-7.94BOHNTR	JUKI	DDL-5580H,DLN-415H	10.0	1.9	32
	mitsubishi	LS2-1180-H			
	TOYOTA	AD340B,AD340B-22			
	TYPICAL	GC6-8-D2			
	SUNSTAR	KM-235B			
	UNICORN	LS2-H5100(H)/H5150H			
HSH-7.94BOHNTR(B)	BROTHER	DB2-B737-5,SL-737A-5,SL-2010-5 S-7200A-405	10.0	1.9	32
	TYPICAL	GC6160H			
	TYPICAL BROTHER	DB2-C201-5			
HSH-7.94BRN	PROTEX	TY-B721-3	8.0	1.45	32
HSH-7.94BRN(H)	HIGHLEAD	GC0618,GC0618-1	10.0	1.9	32
	PROTEX	TY-B721-5			

HORIZONTAL AXIS ROTARY HOOK (DB TYPE) 垂直回转式梭头 (DB 型)

HIGH SPEED TYPE 高速缝梭头

ITEM 广濑品名	APPLICATION 对应機種		NEEDLE SLOT 落针孔		PHOTO PAGE 图片
	BRAND 品牌	MODEL 机型	a	b	
HSH-7.94BSN	JUKI	DLN-415,DLN-5410N	10.0	1.9	32
	SUNSTAR	KM-350A			
HSH-7.94BTR	JUKI	DDL-8700-7,DDL-9000SS,DLM-5400N-7 DLN-5410N-7,DLU-5490N-7	10.0	1.9	32
	MITSUBISHI	LG2-3370-M1T,LS2-1180-M1T LS2-1280-M1T			
	SINGER	691D			
	TOYOTA	AD340-22,AD345-22			
	GEMSY	8900-7			
	JACK	JK8900D			
	PROTEX	TY-B211-413			
	SHANGGONG	GC-30-4-5D,GC555-4-5D			
	ZOJE	ZJ8500-D3,ZJ5580-D3,ZJ8850-5-D3			
	SUNSTAR	KM-235A			
	UNICORN	LS2-H5100(M)/H5150M/H5200/H5300			
	CHUAN NENG	CN-991-3,CN-992-3			
	KINGTEX	KL-300M-A			
※ HSH-7.94BTR(1RPWL)	BROTHER	S-7200A-453,S-7200A-45S RP-series oil free hook	10.0	1.9	32
※ HSH-7.94BTR(2QSP)	JUKI	DDL-9000SS, DLM-5400N-7	10.0	1.65	32
※ HSH-7.94BTR(2QSPFB)	JUKI	non-rotational bobbin hook	10.0	1.65	32
※ HSH-7.94BTR(2SPFB)	JUKI	non-rotational bobbin hook	10.0	1.9	33
※ HSH-7.94BTR(2SPRPWS)	JUKI	DDL-9000DF,DS RP-series oil free hook	10.0	1.9	33
HSH-7.94BTR(3)	HIGHLEAD	GC128-M-D3	6.8	1.9	33
	TYPICAL	GC6-1-D3			
HSH-7.94BTR(491)	SINGER	491UX100/110B/G/H,491UX200/210B/G/H 491UX300/310B/G/H	6.8	1.72	33
HSH-7.94BTR(591B)	SINGER	591C210BD/BF/GD/GF,591C240 591C300BD/BF/GD/GF	10.0	1.9	33
HSH-7.94BTR(591D)	SINGER	591D215,591UX312 601D100AD/AF/BD/BF/GD/GF	6.8	1.72	33
HSH-7.94BTR(591DT)	SINGER	591U with titanium plated base	6.8	1.72	33
HSH-7.94BTR(737)	BROTHER	DB2-B737-3,DB2-B7740,DD7100 S-7200A-403,SL-2010-3,SL-778A-3	6.8	1.9	33
	TYPICAL BROTHER	DB2-C201-3			
HSH-7.94BTR(737SPQ)	BROTHER	DB2-B737-1,S-7200A-43S,SL-737A-1	10.0	1.65	33
	TYPICAL BROTHER	DB2-C201-1			
HSH-7.94BTR(CR)		with hard chrome plated hook point	10.0	1.9	33
HSH-7.94BTR(HP)		super hard point hook	10.0	1.9	33
HSH-7.94BTR(N)	SUNSTAR	KM-350A-7	12.0	1.65	33
※ HSH-7.94BTR(PFQL)	PFAFF	1183	10.0	1.65	33
HSH-7.94BTR(Q)	JUKI	DLM-5400-6	10.0	1.65	33
HSH-7.94BTR(QSP)	JUKI	DDL-9000SS,DLN-5430N-7,DLM-5400N-7 DLN-9010SS,DMN-5420N-7	10.0	1.65	33
HSH-7.94BTR(R)	BROTHER	DB2-B715-1, B716-1, B737-3	6.8	1.9	33
HSH-7.94BTR(RPW)		RP-series oil free hook	10.0	1.9	33
HSH-7.94BTR(SP)		with sharp hook point	10.0	1.9	33
HSH-7.94BTR(SPH)	JUKI	DDL-5550H-6,DDL-9000SH,DLN-9010SH	10.0	1.9	33
HSH-7.94BTR(T)		for light materials	6.8	1.3	33
HSH-7.94BTR(TIN)		with titanium plated base	10.0	1.9	33

※: EXCLUSIVE SELLING ITEM

From the library of: YSM Japan

HORIZONTAL AXIS ROTARY HOOK (DB TYPE) 垂直回转式梭头 (DB型)

HIGH SPEED TYPE 高速缝梭头

ITEM 广濑品名	APPLICATION 对应機種		NEEDLE SLOT 落针孔		PHOTO PAGE 图片
	BRAND 品牌	MODEL 机型	a	b	
HSH-7.94BTR(TS)		with teflon coated base	10.0	1.9	33
HSH-7.94C	SINGER	281,400W/402W/451K	6.8	1.9	33
HSH-7.94C(L)	SINGER	281,400W/402W/451K	6.8	1.9	33
HSH-7.94C(TS)	SINGER	281,400W/402W/451K	6.8	1.9	33
HSH-7.94CO		full automatic open type lubricating system with 3 hook setting screw	6.8	1.9	33
HSH-7.94CO(L)		for synthetic fabrics	6.8	1.9	33
HSH-7.94CO(TS)		with teflon coated base	6.8	1.9	33
HSH-7.94COTR		for under trimming machine	6.8	1.9	34
HSH-7.94CTR	JUKI	DDL-5550U	6.8	1.9	34
	GOLDEN WHEEL	CS-6000BT			
HSH-7.94CTR(TS)		with teflon coated base	6.8	1.9	34
HSH-7.94D	SINGER	281,400W/402W/451K	6.8	1.9	34
HSH-7.94DRN(1)	BROTHER	DB2-B771,SN-771A-3	8.0	1.45	34
HSH-7.94DRNTR	BROTHER	DB2-B790-3-0, B790-303, B791-3-0	8.0	1.45	34
HSH-7.94DTR(1Q)	BROTHER	DB2-B772,SN-772A-3	10.0	1.65	34
HSH-7.94DTR(Q)	BROTHER	DB2-B791-1	10.0	1.65	34
HTE-833	ALTIN(TEXTIMA)	8332	9.0	1.65	34
HTH-614BTR(1.7QE)	UNION SPECIAL	63900AML HTH-series hook. for thin needle	10.0	1.7	34
※ HTH-614BTR(2E)	JUKI	DLN-6390-7 HTH-series hook	10.0	1.85	34
HTH-614BTR(QE)	UNION SPECIAL	63900AML HTH-series hook	10.0	1.8	34
HTH-ATR(E)		HTH-series hook	10.0	2.0	34
※ HTH-BTR(2SPHPNG20E)	JUKI	AVP-875A HTH-series hook. super hard point hook	11.0	1.25	34
HTH-BTR(E)		HTH-series hook	10.0	2.0	34
※ HTH-BTR(HPNG)	BROTHER	BAS-7610	10.0	1.3	34
HUN-614B	UNION SPECIAL	61200/31300,61400/61900,63400/63900	6.8	1.8	34
HUN-614B(L)	UNION SPECIAL	61200/31300,61400/61900,63400/63900 for synthetic fabrics	6.8	1.9	34
HUN-614C	UNION SPECIAL	61200/31300,61400/61900,63400/63900	6.8	1.8	34
HUN-614C(L)	UNION SPECIAL	61200/31300,61400/61900,63400/63900 for synthetic fabrics	6.8	1.9	34
HUN-614C(TS)	UNION SPECIAL	61200/31300,61400/61900,63400/63900 with teflon coated base	6.8	1.8	34

HORIZONTAL AXIS ROTARY HOOK (DB TYPE) 垂直回转式梭头 (DB型)
LARGE TYPE 大型梭头

ITEM 广濑品名	APPLICATION 对应機種		NEEDLE SLOT 落针孔		PHOTO PAGE 图片
	BRAND 品牌	MODEL 机型	a	b	
DBL-C		3 times large capacity hook	10.0	2.0	35
DBM-A(Z14)	STAGER	SZ-21-5-5WN,SZ-21-1BN,SZ-21-3BNL SZ-21-5-4NL,SZ-21-5N,SZ-21-5NL	14.0	3.0	35
	TONY	H-301,H-305			
DBM-A(Z17)		with longer needle slot	17.0	1.9	35
DBM-ATR(7.94)		2 times large capacity hook	14.0	2.0	35
HDU-M265	DURKOPP/ADLER	265-108	14.5	1.3	35
HPF-3518	PFAFF	3518	14.0	1.5	35
HPF-418	PFAFF	417~419,417-900~419-900	14.0	1.5	35
HSM-A	SEIKO	NCL-2BL	14.0	1.9	35
	FLYINGMAN	GC20601			
	GEMSY	7-18A			
	HIGHLEAD	GC0318-1,GC0388,GC188-B			
	JACK	JK6318			
	GOLDEN WHEEL	CS-350L,CS-3811,CS-6100			
	MILLION SPECIAL	MS-370L			
	NITAKA	DY-3300,TC-1530,TC-2530			
	SHIANG WANG	WR-3750,WR-5705			
	YULUN	YLM-340,YLM-350-22			
HSM-A(3)	SUNSTAR	KM-640BL	14.0	1.9	35
	UNICORN	DB2-H312/H510XH/H515XH			
	SIRUBA	L819-X2,YF616-X2,YF619-X2			
HSM-A(5)	SEIKO	STH-series	15.2	1.9	35
HSM-A(6)	JUKI	DNU-241HS	15.2	1.9	35
	CHIKON	CK-8BL,CK-8BL-1,STH-8BL			
	TAKING	TK-8BL			
HSM-A(M2QTS)	BARUDAN	for embroidery machine with teflon coated base	14.0	1.67	35
HSM-A(MQ2L)	BARUDAN	for embroidery machine	14.0	1.67	35
HSM-A1	BROTHER	DB2-B797	9.0	2.5	35
	JUKI	DU-141NH,DU-580			
	SEIKO	H-2B,H-2BL			
	WANPING	GC6-5,GC6-6,GC6-7			
HSM-A1HMTR	mitsubishi	DY-359-22,LY3-6840-B0T PLK-E2010R,PLK-E2516R	14.0	1.9	35
	SUNSTAR	SPS/C-5050			
HSM-A1HTR	HIGHLEAD	GC0388-D,GC128-B-D3	14.0	1.9	35
	TYPICAL	GC6-9-D2			
	WANPING	GN2301,GN2603			
	SUNSTAR	KM-640BL-7			
	UNICORN	LS2-H540/H5400/H5100XH/H5150XH/ H5110XH			
	SIRUBA	L819-X2-U,YF616-X2-U,YF619-X2-U			
HSM-A1HTR(T)	mitsubishi	LY3-6850-B1T	14.0	1.9	35
	SIRUBA	YC619-X2			
HSM-A1SH	JUKI	DDL-201S,DSU-144N	9.0	2.5	35
HSM-A1TR(280)	JUKI	DNU-1541,DNU-241H,DNU-261H DSC-246,246V	14.0	2.3	35
	SUNSTAR	KM-590BL			

※ : EXCLUSIVE SELLING ITEM

From the library of: YSM Japan

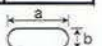

HORIZONTAL AXIS ROTARY HOOK (DB TYPE) 垂直回转式梭头 (DB型)

LARGE TYPE 大型梭头

ITEM 广濑品名	APPLICATION 对应機種		NEEDLE SLOT 落针孔		PHOTO PAGE 图片
	BRAND 品牌	MODEL 机型	a	b	
HSM-AM(3)	MITSUBISHI	LS2-1130-B,LS2-1130-BOB,LS2-130-BOB	14.0	1.9	35
HSM-AR(1.7)		for skip-free stitching	10.0	1.7	35
HSM-AR(2.1)		for skip-free stitching	10.0	2.1	35
※ HSM-AR(PNG)	PRINCE	LZP-6000NCN,SPX-200CNC,SPZ-600 for skip-free stitching	16.5	1.9	35
HSM-ARTR(1.7)		for skip-free stitching	10.0	1.7	35
HSM-ARTR(2.1)		for skip-free stitching	10.0	2.1	35
※ HSM-ARTR(ABHP)		super hard point hook,for skip-free stitching	9.0	2.5	35
HSM-ATR(1Q)	BROTHER	BE-0101B-AC,BES-1210AC	14.0	1.67	35
HSM-ATR(1QTS)		with teflon coated base	14.0	1.67	35
HSM-ATR(MQ1L)	BROTHER	BES-1260BC,BES-1240BC	14.0	1.67	36
※ HSM-ATR(PFNGOPTS)L	PFAFF	KSM-200	9.0	1.5	36
HSM-B	TOYOTA	D324	14.0	1.9	36
HSM-B(1SU)	SUNSTAR	KM-146BL	14.0	1.9	36
HSM-B(IE)	IDEAL	IE6000	9.0	1.95	36
	NECCHI	POCKETSETTER			
HSM-B(Q)TR	SINGER	121C330AA,121D330AA,369	14.0	1.67	36
HSM-B(SU)	SUNSTAR	KM-380BL	14.0	1.9	36
HSM-B(Z17)	TOYOTA	D530,D532,D534	17.0	1.9	36
	CHUAN NENG	CN-915-3,CN-915-5			
HSM-B1	JUKI	DDL-201,DDL-5600NJ,DDL-5600NL	9.0	2.5	36
HSM-B1H	JUKI	DDL-201H	9.0	2.5	36
	WANPING	B727,GC0302			
HSM-B1H(1)	BROTHER	DB2-B746A,SL-746A	14.0	2.5	36
HSM-B1HTR	BROTHER	DB2-B748A,DB2-B798,SN-7230-5 SN-7240-5	14.0	1.9	36
	WANPING	GC0302-D2			
HSM-B1HTR(1Q)	BROTHER	BAS-36,350	14.0	1.67	36
HSM-B1HTR(2)	JUKI	DDL-5600NL-7-0B,DLN-5410NJ-7 DSU-145-7	14.0	1.9	36
※ HSM-B1HTR(BB)	VI.BE.MAC	for pocket setter machine	14.0	1.8	36
HSM-BRTR(1.7)		for skip-free stitching	10.0	1.7	36
HSM-BRTR(2.1)		for skip-free stitching	10.0	2.1	36
※ HSM-BRTR(HP370)	BROTHER	BAS-346E,366E super hard point hook	10.0	1.9	36
HSM-Z17		with short hook gib	17.0	1.9	36
HST-A	BROTHER	LK3-B484(KE-484C)	8.0	2.5	36
HST-A(C)	BROTHER	KE-484C-X,LK3-B484(KE-484C)	8.0	3.0	36
HST-A(CNG)			8.0	1.6	36
※ HST-A(HPQC)	JUKI	LK-1941,1942 super hard point hook	8.0	2.2	36
HST-A(LP)		with long hook point	8.0	2.5	36
※ HST-A(ME)	MECA	for quilting machine	9.0	2.5	36
※ HST-B1(HPA)	JUKI	LK-1941,1942	8.0	2.2	36
HTM-A		HTM-series hook	14.0	1.9	36
HTM-A1HTR		HTM-series hook	14.0	1.9	36
※ HTM-BTR(HP761)	BROTHER	BAS-761,BAS-7610	11.0	1.32	37

HORIZONTAL AXIS ROTARY HOOK (DB TYPE) 垂直回转式梭头 (DB型)

LOW SPEED TYPE 低速缝梭头

ITEM 广濑品名	APPLICATION 对应機種		NEEDLE SLOT 落针孔		PHOTO PAGE 图片
	BRAND 品牌	MODEL 机型	a	b	
DA1-A	mitsubishi	CU-865-12	6.8	1.9	38
	SINGER	95-40/96-40			
DA1-A(7.94)	SINGER	195K,196K	6.8	1.9	38
DA1-A(7.94ST)		for thick thread sewing	6.8	2.0	38
DA1-A1		for extra heavy materials	6.8	2.3	38
DA1-AH		for heavy materials, bag	6.8	1.75	38
DA1-ATR	YAKUMO	380,380L	12.0	1.75	38
DA1-ATR(1QB)	BROTHER	PR-600	10.0	1.65	38
DA1-B	DURKOPP/ADLER	96,206,207	6.8	1.9	38
	JANOME	TA-J761,TA-J763,TA-J766			
	JUKI	DDL-115			
	MITSUBISHI	LX2-371-MO			
	NECCHI	800,801,810,813			
	SINGER	95-40/96-40			
	GOLDEN WHEEL	CS-3600,CS-8000-20,CS-8000-30			
DA1-B(109)	ALFA	102,109	10.0	1.5	38
DA1-B(7.94)	SINGER	195K,196K	6.8	1.9	38
DA1-B(K)		for extra heavy materials, sports shoes & bag	6.8	1.6	38
DA1-BOH(AL)	ALFA	127, 157	9.0	1.6	38
DA1-BTR	SUNSTAR	KM-380	12.0	1.75	38
DA1-C	SINGER	95-40/96-40	6.8	1.9	38
DA1-C(AL)	ALFA	127,157	9.0	1.6	38
DA1-CTR	BROTHER	TA2-B623	6.8	1.9	38
DA2-A (TA1-A)	SINGER	103K,95-10/96-10	6.8	1.9	38
DA2-B (TA1-B)	DURKOPP/ADLER	203,204,205	6.8	1.9	38
	SINGER	103K,95-10/96-10			
DA2-C (TA1-C)	SINGER	103K,95-10/96-10	6.8	1.9	38
DB1-BZ(20)	SINGER	20U13/23	18.0	1.85	38
	PROTEX	GG20U			
	GOLDEN WHEEL	CS-2180			
	MILLION SPECIAL	MS-20U143			
DB1-BZ(20L)	SINGER	20U31/33/34	18.0	1.85	38
DB1-Z(20)	SINGER	20U13/23	18.0	1.85	38
	PANDA	JL-20U			
DB1-Z(20L)	SINGER	20U43,20UX143	18.0	1.85	38
DB1-Z16	DURKOPP/ADLER	199,289,489	16.0	2.8	38
	JUKI	LZ-271			
	NECCHI	533,720,840			
	MEIJIA	G15-2			
	TYPICAL	GG1-1,GG1-2			
	SUNSTAR	KLZ-371			
	UNICORN	LZ2-H272			
DB1-Z16(LP)		with long hook point	16.0	2.8	38
DB1-Z16(TS)		with teflon coated base	16.0	2.8	38
DB1-Z16(TU)	STAGER	SE-12,SZ-21-1N,SZ-21-4N,SZ-72N	16.0	2.8	38
DB1-Z16B	BROTHER	TZ1-B652	16.0	1.9	38
	UNICORN	TZ1-B652			

※ : EXCLUSIVE SELLING ITEM

From the library of: YSM Japan

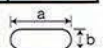

HORIZONTAL AXIS ROTARY HOOK (DB TYPE) 垂直回转式梭头 (DB型)

LOW SPEED TYPE 低速缝梭头

ITEM 广濑品名	APPLICATION 对应機種		NEEDLE SLOT 落针孔		PHOTO PAGE 图片
	BRAND 品牌	MODEL 机型	a	b	
DB1-Z16B	MILLION SPECIAL	MS-B652	16.0	1.9	38
	YULUN	YLM-335			
DB1-Z39	JUKI	LZ-39	16.0	2.8	39
DB1-Z710	JUKI	LZ-391,LZ-391N	16.0	2.4	39
HDU-265	DURKOPP/ADLER	265	9.0	1.6	39
HDU-265Y	YAMATO	DP-1101,DP-1111	10.0	1.75	39
HM2-F10(EL)	ALFA	home-use machine	10.0	1.75	39
HM2-FATR(1)	BROTHER	nouvelle250,450	10.0	1.9	39
HM2-FBTR(SS)	SINGER	home-use machine	10.0	1.9	39
HPF-134	PFAFF	133,134	10.0	1.7	39
	ZSK	for embroidery machine			
HPF-230(W)	PFAFF	130,138	13.5	3.3	39
HPF-234	PFAFF	234	10.0	1.7	39
HPF-238	PFAFF	130,138,238	10.0	2.0	39
HPF-335	PFAFF	138,335,337-734	10.0	2.0	39
	WANPING	TW3-P335			
HPF-335(5)	DURKOPP/ADLER	69-373	11.5	2.1	39
	SEIKO	HC-2B,LSC-8B,LSC-8BV			
	WANPING	TW3-335V			
HPF-438	PFAFF	437~439	10.0	1.3	39
HPF-438(CR)	PFAFF	437~439 with hard chrome plated hook point	10.0	1.3	39
HPF-563TR(RP)	PFAFF	487NL,489NL,563NL RP-series oil free hook	10.0	1.7	39
HSH-7.94A(M1Q)		for embroidery machine	6.8	1.65	39
HSH-7.94A(M1QTS)		for embroidery machine with teflon coated base	6.8	1.65	39
HSH-7.94A(M3Q)	HAPPY	HCM,HMF	6.8	1.65	39
HSH-7.94A(MTQ)		for embroidery machine	6.8	1.65	39
HSH-7.94ATR(M1Q)	BARUDAN	for embroidery machine	6.8	1.65	39
HSH-7.94ATR(M1QH)	BARUDAN	BEDSH,BEDXH,BEDYH	6.8	1.65	39
HSH-7.94ATR(M1QTS)	BARUDAN	BEDSH,BEDTHE,BEDYH,BEDYHE	6.8	1.65	39
HSH-7.94ATR(M1QTSL)		for embroidery machine,with teflon coated base,with lubricating channel	6.8	1.65	39
HSH-7.94ATR(M3Q)	HAPPY	HCG,HCM,HCS,HMF	6.8	1.65	39
HSH-7.94ATR(MQ2)	BARUDAN	BEDSH,BEDYH	6.8	1.65	39
HSH-7.94ATR(MQRP)		RP-series oil free hook for embroidery machine	10.0	1.65	39
HSH-7.94ATR(MQRPW)		RP-series oil free hook for embroidery machine	6.8	1.65	39
※ HSH-7.94ATR(MQSU)	SWF	SWF/B-UI1212-45	6.8	1.65	40
※ HSH-7.94ATR(MQSUL)	SWF	SWF/B-UK1202-45,with lubricating channel	6.8	1.65	40
※ HSH-7.94ATR(MQSUNL)	SWF	SWF/B-UI1212-45,SWF/B-UK1202-45 SWF/C-WD920-55,SWF/C-WD920-55 with lubricating channel	6.8	1.65	40
HSH-7.94ATR(MTQ)		for embroidery machine	6.8	1.65	40
※ HSH-7.94ATR(MTQEL)	TAJIMA	TFGN-,TFGN-C,TFJT-C,TFKN-,TFMX- II TFMX- II C,TFMX-C	6.8	1.65	40
※ HSH-7.94ATR(MTQETA)	TAJIMA	TFGN-,TFGN-C,TFJT-C,TFKN-,TFMX- II TFMX- II C,TFMX-C	6.8	1.65	40
HSH-7.94ATR(MTQRP)		RP-series oil free hook for embroidery machine	10.0	1.65	40

HORIZONTAL AXIS ROTARY HOOK (DB TYPE) 垂直回转式梭头 (DB 型)
LOW SPEED TYPE 低速缝梭头

ITEM 广濑品名	APPLICATION 对应機種		NEEDLE SLOT 落针孔		PHOTO PAGE 图片
	BRAND 品牌	MODEL 机型	a	b	
HSH-7.94ATR(MTQTS)		for embroidery machine with teflon coated base	6.8	1.65	40
HSH-7.94B(188UL)	SINGER	188U	6.8	1.9	40
HSM-ATR(MQRPLN)	BROTHER	for embroidery machine	14.0	1.67	40
HSM-ATR(MTQ)		for embroidery machine	14.0	1.67	40
HSM-ATR(MTQTS)		for embroidery machine with teflon coated base	14.0	1.67	40
HTH-ATR(MQE)		HTH-series hook, for embroidery machine			40
※ HTH-ATR(MQESU)	SWF	SWF/C-WE1206-75,SWF/H-WD920-55 SWF/B-UK1204-45	10.0	1.8	40
※ HTH-ATR(MQESUL)	SWF	SWF/C-WE1206-75,SWF/H-WD920-55 SWF/B-UK1204-45	10.0	1.8	40
※ HTH-ATR(MQESUNL)	SWF	SWF/B-UK1204-45,SWF/C-WE1204-55/75 SWF/H-WD920-55	10.0	1.8	40
TA1-Z16	SINGER	306M,319,320	16.0	2.8	40

HORIZONTAL AXIS ROTARY HOOK (DP TYPE) 垂直回转式梭头 (DP 型)

HIGH SPEED ZIGZAG TYPE 高速人字型缝梭头

ITEM 广濑品名	APPLICATION 对应機種		PHOTO PAGE 图片
	BRAND 品牌	MODEL 机型	
DP2	DURKOPP/ADLER	91,253,255	41
	PEGASUS	DPS-2,DPS-3,DPS-4	
	SINGER	107G,107W1/3/5/17	
	YAMATO	DP-2,DP-3	
	SUNSTAR	DPK-2	
DP2(B)	BROTHER	DL1-B832,B813,LZ1-B851	41
DP2(H)		for heavy materials	41
DP2(HS)	YAMATO	DP-2,DP-3	41
DP2-457(HP)	SINGER	457A,457G super hard point hook	41
DP2-457(LHP)	SINGER	457A,457G super hard point hook	41
DP2-457U(T)	SINGER	457A	41
	JACK	JK457	
	ZOJE	ZJ457A135,ZJ457A143,ZJ457A125/105	
	YULUN	475A-505-PBG-NHL,475A-625-NCB-LG	
DP2-457UTR	SINGER	457U, 457G under trimming machine	41
DP2-57(2)	SINGER	457G	41
DP2-57(2)IN		for lingerie sewing	41
DP2-57(2HPTS)		super hard point hook with teflon coated base	41
DP2-57(2LP)	SINGER	457G	41
	YULUN	475A-125L,475A-140L,YLM-457A	
DP2-57(2LPA)	STAGER	SZ-310-11N,SZ-310-1N,SZ-310-3N SZ-310-3N	41
DP2-57(2LPRP)	SINGER	457G RP-series oil free hook	41
DP2-57(2LPY)	YAMATO	LG2125 LW	41
DP2-57(2RP)		RP-series oil free hook	41
DP2-57(3LP)	JUKI	LZ-1280	41
DP2-57(3LP2)	JUKI	LZ-2280	41
DP2-57(3LP2R)	JUKI	LZ-2280N, 2281N	41
	GEMSY	2284,2284-7	
	YULUN	475A-143NL,475A-643-NCB-LG	
DP2-57(3LP2RHP)		super hard point hook	41
※ DP2-57(3LP2V)	JUKI	LZ-2282N-7, 2284N-7,LZ-2290A-SR-7-CB LZ-2290A-SS,LZ-2290A-SU	41
※ DP2-57(3LP2VHP)	JUKI	LZ-2282N-7, 2284N-7 super hard point hook	41
※ DP2-57(3LP2VRPW)	JUKI	LZ-2290A-DS-7-CB,LZ-2290A-DU-7-CB RP-series oil free hook	41
DP2-71	SINGER	271K	41
DP2-800FR	BROTHER	HE-8000-2,HE-8000-3,HE-8000-5	41
	SUNSTAR	BH/3000	
DP2-815	BROTHER	LH4-B815	41
DP2-815(FR)	BROTHER	LH4-B815 front side hook gib screw	41
DP2-816	BROTHER	BAS-511,LH4-B816	41
DP2-816(FR)	BROTHER	BAS-511,LH4-B816 front side hook gib screw	42
DP2-817	BROTHER	LH4-B817	42
DP2-818(FR)	BROTHER	HM-8180 front side hook gib screw	42
DP2-855	BROTHER	ZE-855A,ZE-8570	42
	SUNSTAR	KM-2070	

HORIZONTAL AXIS ROTARY HOOK (DP TYPE) 垂直回转式梭头 (DP 型)
HIGH SPEED ZIGZAG TYPE 高速人字型缝梭头

ITEM 广濑品名	APPLICATION 对应機種		PHOTO PAGE 图片
	BRAND 品牌	MODEL 机型	
DP2-856TR	BROTHER	ZE-856A,ZE-8580	42
	SUNSTAR	KM-2077	
DP2-L(N)	SINGER	107G,107W1/3/5/17,143W1	42
DP2-LB	BROTHER	LH4-B814	42
DP2-NJ	JUKI	LBH-761~3	42
	SHANGGONG	G15	
DP2-NJ(790)	JUKI	LBH-1700,LBH-1790S,LBH-791S~794S	42
DP2-NJ(791K)	JUKI	LBH-1792K	42
DP2-NJ771	JUKI	LBH-771~773,LBH-781~784	42
	DALIAN	G18	
	JACK	JK781	
	SHANGGONG	GF108	
	K-CHANCE	KBH-780	
	PANDA	JL-781	
	TAKING	TK-888	
HDU-556	DURKOPP/ADLER	556	42
HPF-3114	PFAFF	114,3114,3115	42
HPF-3116	PFAFF	3116	42
HSH-102	SINGER	107W100/102/103	42
HSH-51-1	SINGER	151K,151W	42
HSH-8-20	DURKOPP/ADLER	460	42
	SINGER	108K	
HSH-8-20(K)	SINGER	108K for heavy materials	42

VERTICAL AXIS ROTARY HOOK 水平回转式梭头
STANDARD TYPE with SHANK 短轴小型梭头

ITEM 广濑品名	APPLICATION 对应機種		PHOTO PAGE 图片
	BRAND 品牌	MODEL 机型	
HAD-68	DURKOPP/ADLER	67,68	43
HDU-249	DURKOPP/ADLER	249,380,549	43
HPF-151	PFAFF	141~146,151,191~196	43
HPF-442	PFAFF	441~448,451~457	43
HPF-442TR	PFAFF	441-900~448-900	43
HPF-442TR(L)	PFAFF	441-900~448-900	43
HPF-490	PFAFF	471~493	43
	SEIKO	PWB-8W	
HPF-490(5)TR	SEIKO	PWB-8GWC,PWB-8GWC-FL	43
	UNICORN	LT5-H7200/H7600	
HPF-490(A)	PFAFF	471~493	43
	SEIKO	PWB-8GW	
	HIGHLEAD	GC24618,GC24618-1	
	WANPING	GC24660,GC24680,PWB-8GW	
	SUNSTAR	KM-957	
	GOLDEN WHEEL	CS-862,CS-8810,CS-8820	
	MILLION SPECIAL	MS-491-800,MS-674-500	
	NITAKA	TC-881,TC-882	
	TAKING	TK-692,TK-991,TK-992	
	YULUN	YLM-572W,YLM-671W	
HPF-490A(5)TR	SUNSTAR	KM-867-7	43
	GOLDEN WHEEL	CS-6111B,CS-6111BT,CS-6112BT	
	MILLION SPECIAL	MS-474-530,MS-674-530,MS-691-830	
	SHIANG WANG	WR-9910-T,WR-991-T,WR-9920-T WR-992-T	
	SIRUBA	R718-01-U,R728-U	
HPF-490A(N)	SIRUBA	R718-01,R718-02,R728	43
HPF-490AH(N)	SIRUBA	R718-01H,R728-xxH	43
HPF-490TR	PFAFF	471-900~493-900	43
HSH-10-100	SINGER	110K,110W124/128,21W162	43
HSH-10-100(A)	SINGER	110K with short hook gib	43
	SINGER	110W124/128,21W162	
HSH-10-100M	MITSUBISHI	PB-810. 820. 840	43
HSH-18-4	SINGER	118W	43
HSH-18-4A		with short hook gib	43
HSH-18-4C		with tacking hook gib	43
HSH-19	SINGER	110W-2,119W	43
HSH-2-12	SINGER	21W162,22W	43
HSH-22-21	SINGER	21W162	43
HSH-31	SINGER	153W,21W180/182,52W30/31	43
HSH-31(12)	SEIKO	LPW-6B,LPW-7B,LPW-8B,PW-6B,PW-7B	43
	SINGER	131W,131W103/104/110/113	
	WANPING	GC24016,TW5-810	
	SUNSTAR	KM-867	
	FENG YING	FY-810,FY-820	
	GOLDEN WHEEL	CS-3610,CS-8BH	
	KING'S	HC-810,HC-820,HC-919,HC-929	

VERTICAL AXIS ROTARY HOOK 水平回转式梭头
STANDARD TYPE with SHANK 短轴小型梭头

ITEM 广濑品名	APPLICATION 对应機種		PHOTO PAGE 图片
	BRAND 品牌	MODEL 机型	
HSH-31(12)	MILLION SPECIAL	MS-810,MS-820	43
	NITAKA	TC-810,TC-820	
	TAKING	TK-810,TK-820	
	YULUN	YLM-810-G,YLM-820-G	
HSH-31(6)	JUKI	PLH-981,PLH-982,PLN-985~986	43
	HIGHLEAD	GC24018,GC24018-1,GC24518-1 GC24518-2	
	GOLDEN WHEEL	CS-5362N,CS-7362,CS-822	
	NITAKA	TC-810S,TC-820S	
	SHIANG WANG	WR-810,WR-820	
	SIRUBA	P717,P727	
HSH-31(B)	SEIKO	CW-SERIES	43
	SINGER	131W,47W70	
	WANPING	TW3-8B	
HSH-31(B12)	SEIKO	LPW-26B,LPW-27B,PW-26B,PW-27B	43
	UNICORN	PLN-7B/27B/LT5-H710/H720	
HSH-36-1	SINGER	136W	43
HSH-36-2	SINGER	236G120/124/125,236W	44
HSH-5-16	SINGER	136W,52K,52W22	44
HSH-68-1	SINGER	167G/W	44

VERTICAL AXIS ROTARY HOOK 水平回转式梭头
STANDARD TYPE with SHAFT 长轴小型梭头

ITEM 广濑品名	APPLICATION 对应機種		PHOTO PAGE 图片
	BRAND 品牌	MODEL 机型	
H12-15L	JUKI	LH-3120A,LH-3120F,LH-3128	45
H12-15L(TR2)	JUKI	LH-3128-7	45
※ H12-15L(TR2AE)	JUKI	LH-3126F	45
※ H12-15L(TR2FB)	JUKI	non-rotational bobbin hook	45
H12-15LC	JUKI	LH-3168	45
H12-15LCTR2	JUKI	LH-3128-7,LH-3162-7,LH-3168-7	45
H12L(1)	JUKI	LH-3128	45
HG12-15L	BROTHER	LT2-B841-3,LT2-B842-3	45
	JACK	JK5842-3	
	PROTEX	TY-B842-3	
	TYPICAL	GC6842M	
	ZOJE	ZJ842	
	SIRUBA	T828-41-ML,T828-42-LL,T828-47-ML	
HG12-15L(H)	BROTHER	LT2-B841-5,LT2-B842-5	45
	PROTEX	TY-B842-5	
	TYPICAL	GC6842H	
	ZOJE	842-5	
HG12-15L(TR1)	BROTHER	LT2-B842	45
	GEMSY	842	
	WANPING	842	
	ZOJE	842-D3	
	MILLION SPECIAL	MS-B842-403,MS-B842-405	
	NITAKA	TC-B842-403,TC-B842-405	
	SICAMA	LT2-B842-580	
	SIRUBA	T828-42-ML-U,T828-47-LL-U	
HG12-15LC	BROTHER	LT2-B845	45
	GEMSY	845	
	JACK	JK5845-3	
	TYPICAL	GC6845H	
	WANPING	TW2-B845-5	
	ZOJE	845	
	SIRUBA	T828-45-H,T828-45-M,T828-48-L	
HG12-15LCTR1	BROTHER	LT2-B845	45
	JACK	JK5845-5	
	PROTEX	TY-B845-403	
	TYPICAL	GC6845HD3,GC6845MD3	
	WANPING	845	
	ZOJE	845-D3	
	SICAMA	BEISLER 845,YAZICI 845	
	SIRUBA	T828-45-M-U,T828-45-X-U T828-48-L-U	
HG12L(1)	BROTHER	LT2-B841	45
	SIRUBA	T828-41,T828-42,T828-47	
HG12L(1)TR1	BROTHER	LT2-B842	45
	TYPICAL	GC6842HD3,GC6842MD3	
	SICAMA	BEISLER 842,YAZICI 842	
	SIRUBA	T828-42-U,T828-47-U	

※ : EXCLUSIVE SELLING ITEM

VERTICAL AXIS ROTARY HOOK 水平回转式梭头
STANDARD TYPE with SHAFT 长轴小型梭头

ITEM 广濑品名	APPLICATION 对应機種		PHOTO PAGE 图片
	BRAND 品牌	MODEL 机型	
HR12-15L	BROTHER	T-8420A-003,T-8420A-00F,T-8420A-033 T-8421A-T03,TN-842A-003	45
	SUNSTAR	KM-750	
HR12-15L(H)	BROTHER	T-8420A-005,T-8421A-T05,TN-842A-005	45
HR12-15L(TR1)	BROTHER	T-8422A-403,TN-842B-403	45
	SUNSTAR	KM-750-7	
HR12-15LC	BROTHER	T-8450A-003,T-8450A-005,TN-845A-003 TN-845A-005	45
	SUNSTAR	KM-790	
HR12-15LCTR1	BROTHER	T-8452A-403,T-8452A-433,TN-845B-401 TN-845B-403	45
	SUNSTAR	KM-790-7	
HR12L(1)	BROTHER	T-8421A-T03	45
HR12L(1)TR1	BROTHER	T-8422A-403,TN-842B-40F	45
HSH-11-51	SINGER	111W150~151	45
HSH-11-53	SINGER	111W100~103,111W153~154	45
HSH-11-55	SEIKO	STW-6,STW-7,STW-8,STW-8BV STW-8V	45
	SINGER	111W155/156,211G155/156 211U341/365	
HSH-11-55M(2)	JUKI	LH-525N,LH-529	45
HSH-12(2)	JUKI	LH-1152	45
HSH-12(2)TR	JUKI	LH-1152-4	45
HSH-12(570)	JUKI	APW-192N~196N,APW-231N~239N LH-570, 571	45
HSH-12-11M	MITSUBISHI	DU-100, DU-105, DU120	46
HSH-12-15	SINGER	112W115~139	46
HSH-12-15(2)	JUKI	LH-1152	46
HSH-12-15(2)TR	JUKI	LH-1152-4	46
HSH-12-15(A)	SINGER	112W110,112W115~139 with short hook gib	46
HSH-12-15L	BROTHER	LT2-B831	46
	SEIKO	LTW-26,LTW-27	
	SUNSTAR	KM-740	
	SICAMA	LT2-B842	
HSH-12-15L(H)	BROTHER	LT2-B831-5	46
	GOLDEN WHEEL	CS-3100-3,CS-872-3	
HSH-12-15L(TR)	BROTHER	LT2-B832-3-0, 401, 403	46
HSH-12-15L(TR1)	BROTHER	LT2-B832-3-0(A), 400	46
	JACK	JK5842-5,JK5842D-3	
HSH-12-15LC	BROTHER	LT2-B835	46
	SEIKO	LTW-27BK	
	GOLDEN WHEEL	CS-3150,CS-3150-5,CS-875-3	
	NITAKA	TC2-B845	
HSH-12-15LCTR	BROTHER	LT2-B835-3-0, -5-0, -400	46
HSH-12-15LCTR1	BROTHER	LT2-B835-3-0(A), -5-0(A)	46
HSH-12-15LTR(H)	BROTHER	LT2-B832-5-0, -405	46
HSH-12-15M	MITSUBISHI	LT2-2220-MOB	46
	SINGER	211A,212A141BA,412U	
	GEMSY	2000-1M	

※ : EXCLUSIVE SELLING ITEM

From the library of: YSM Japan

VERTICAL AXIS ROTARY HOOK 水平回转式梭头
STANDARD TYPE with SHAFT 长轴小型梭头

ITEM 广濑品名	APPLICATION 对应機種		PHOTO PAGE 图片
	BRAND 品牌	MODEL 机型	
HSH-12-15M	HIGHLEAD	GC20518-M	46
	TYPICAL	GC20201	
	UNICORN	DB2-H320/321/LS2-H620(M)	
	GOLDEN WHEEL	CS-7162,CS-7162S	
	MILLION SPECIAL	MS-B842-3,MS-B842-5	
	TAKING	TK-832	
HSH-12-15M(3)	MITSUBISHI	LT2-2250-M1TW,LX2-630-M1	46
	TYPICAL	GC6240MD	
HSH-12-15M(3UC)	UNICORN	LT2-H6250(M)	46
HSH-12-15MTR	MITSUBISHI	LT2-230M	46
HSH-12-15MTR(3)	MITSUBISHI	LT2-2230-M1TW	46
	TYPICAL	GC6220MD	
	UNICORN	LT2-H6200(M)	
HSH-12-40	SINGER	112W140/145/146	46
HSH-12-62C(L)	JUKI	LH-1162 left hand	46
HSH-12-62C(R)	JUKI	LH-1162 right hand	46
HSH-12-62CTR(L)	JUKI	LH-1162-4 left hand	46
HSH-12-62CTR(R)	JUKI	LH-1162-4 right hand	46
HSH-12-68	SINGER	112W115~139	46
HSH-12C	MITSUBISHI	LT2-2240-MOB	46
	GEMSY	2000-2M	
	HIGHLEAD	GC20528-M	
	TYPICAL	GC6240M	
	UNICORN	LT2-H625(M)	
	GOLDEN WHEEL	CS-7165,CSL-1720	
	MILLION SPECIAL	MS-B845,MS-B845-3,MS-B845-5	
	NITAKA	TC2-B1883	
HSH-12L(1)	BROTHER	LT2-B832-1, 3, 5	46
HSH-12L(1)TR	BROTHER	LT2-B832-3-0	46
HSH-12L(1)TR1	BROTHER	LT2-B832-3-0, -5-0, -401	46

VERTICAL AXIS ROTARY HOOK 水平回转式梭头
STANDARD TYPE with BOSS (HUB) 轴套小型梭头

ITEM 广濑品名	APPLICATION 对应機種		PHOTO PAGE 图片
	BRAND 品牌	MODEL 机型	
HSH-21-40	SINGER	211G146/151,211GX110,212W140/145/146	47
HSH-21-40(2)	JUKI	LH-528	47
HSH-21-40(AJ)	JUKI	LH-512H, 515H	47
HSH-21-40(HP)	SINGER	super hard point hook	47
HSH-21-40(J)	JUKI	LH-512,515	47
	SHANGGONG	GC15-5-4D,GD9,GDB	
HSH-21-40(S)C	SINGER	212UHV,443A	47
HSH-21-40A(2)	JUKI	APW-116	47
HSH-21-40TR	SINGER	211G451/457,212G140/141/145/440 212U441	47
HUN-622	UNION SPECIAL	61800/62200	47

VERTICAL AXIS ROTARY HOOK 水平回转式梭头
LARGE TYPE with SHANK 短轴大型梭头

ITEM 广濑品名	APPLICATION 对应機種		PHOTO PAGE 图片
	BRAND 品牌	MODEL 机型	
HAD-160(1341A)	JUKI	PLC-1760	48
HAD-160(6)	JUKI	PLC-1660L,PLC-1665	48
HAD-160TR(6)	JUKI	PLC-1610-7,PLC-1660-7	48
HAD-161(6)	JUKI	PLC-1610,PLC-1660,PLC-1690A	48
HAD-166TR	JUKI	PLC-1660-7	48
HAD-167	DURKOPP/ADLER	167,267,268	48
HAD-167TR	DURKOPP/ADLER	167-FA272,167-FA272NH,267-FA	48
HAD-267TR	DURKOPP/ADLER	268-FA	48
HPF-1242	PFAFF	1242-720,1244-748	48
HPF-1242(A)	PFAFF	1241~1246,1242-720,1244-748	48
	WANPING	1245	
	MILLION SPECIAL	MS-1245	
	TAKING	TK-1245,TK-1246	
	YULUN	YLM-1245,YLM-545,YLM-546	
HPF-1242(A)TR	PFAFF	1244-720-900,1246-900	48
HPF-1242TR	PFAFF	1242-720-900,1246-900	48
HPF-545	PFAFF	541~546,544-720,551~555,591~596	48
	KING'S	HC-616,HC-618	
	TAKING	TK-545,TK-546	
HSH-12-15MM(S)	SINGER	2110X104/106,211U566,212G539/541	48
HSH-12-15MM(S)C	SINGER	212U543A,544A	48
HSH-12MS	SINGER	411U557A/J/K, 412U541A/B/G	48
HSH-12MS(5)	SINGER	411U907A/J/K, 412U939A/J/K	48
HSH-31MMB(5)	SEIKO	LCW-8BL,LCW-8BL-1	48
	SUNSTAR	KM-390BL	
HYM-1341ATR(6)	JUKI	LS-1342-7	48
HYM-1341AY	WANPING	TW3-341	48
HYM-1341AY(6)	JUKI	LS-1342	48
HYM-1341BTR(6)	JUKI	LS-1342-7	48
HYM-1341BY	JUKI	LS-1341	48
HYM-1341BY(6)	JUKI	LS-1342	48

VERTICAL AXIS ROTARY HOOK 水平回转式梭头
LARGE TYPE with SHAFT 长轴大型梭头

ITEM 广濑品名	APPLICATION 对应機種		PHOTO PAGE 图片
	BRAND 品牌	MODEL 机型	
H12M-78TR	JUKI	LH-2178-7	49
H12MC(2)	JUKI	LH-3178,LH-3188	49
H12MC(2)TR	JUKI	LH-3178-7,LH-3188-7	49
H12MM(2)	JUKI	LH-3178	49
H12MM(2)TR	JUKI	LH-3178-7	49
HG12M(BR)	BROTHER	LT2-B872	49
	GEMSY	872	
	JACK	JK5872-3	
	PROTEX	TY-B872-5	
	TYPICAL	GC6872H,GC6872M	
	ZOJE	872	
	SIRUBA	T828-72-HL,T828-72-ML	
HG12MC(1)	BROTHER	BAS-612,613,LT2-B875	49
	GEMSY	875	
	JACK	JK5875-3	
	PROTEX	TY-B875-5	
	TYPICAL	GC6875H,GC6875M	
	WANPING	TW2-B875	
	ZOJE	875	
HG12MC(1)TR	BROTHER	BAS-6200,LT2-B872,LT2-B875	49
	GEMSY	872-7,875-7	
	JACK	JK5872-5,JK5875-5	
	TYPICAL	GC6872MD3,GC6875HD3,GC6875MD3	
	WANPING	872,875	
	ZOJE	875-D3	
	MILLION SPECIAL	MS-B872-403,MS-B872-405,MS-B875-403 MS-B875-405	
	NITAKA	TC-B872-403,TC-B875-403,TC-B875-405	
HR12M(BR)	BROTHER	T-8720A-003,T-8720A-005,TN-872A-003	49
	SUNSTAR	KM-750BL	
HR12MC(1)	BROTHER	T-8750A-003,TN-875A-003	49
	SUNSTAR	KM-790BL	
HR12MC(1)TR	BROTHER	T-8722A-403,T-8752A-403,T-8752A-405 TN-872B-403	49
	SUNSTAR	KM-790BL-7	
HSH-12-15MM	MITSUBISHI	LT2-2220-BOB	49
	BAOMA	GC20508-C	
	CHURCHILL	QJ2230B	
	GEMSY	2001-1B	
	HIGHLEAD	GC20528-B	
	TYPICAL	GC20202	
	SUNSTAR	KM-740BL	
	UNICORN	DB2-H322/323/LS2-H620(H)	
	GOLDEN WHEEL	CS-3100L,CS-871L,CS-872L	
	MILLION SPECIAL	MS-B872-3,MS-B872-5	
NITAKA	TC2-B935		

※ : EXCLUSIVE SELLING ITEM

From the library of: YSM Japan

VERTICAL AXIS ROTARY HOOK 水平回转式梭头

LARGE TYPE with SHAFT 长轴大型梭头

ITEM 广濑品名	APPLICATION 对应機種		PHOTO PAGE 图片
	BRAND 品牌	MODEL 机型	
HSH-12-15MM	TAKING	TK-832-LB5,TK-872	49
HSH-12-15MM(3)TR	MITSUBISHI	LT2-2230-B1T	49
	TYPICAL	GC6220BD	
	UNICORN	LT2-H6200(H)	
HSH-12-15MM(410)	HIGHLEAD	GC20618-1D	49
HSH-12-15MM(410M)	SIRUBA	UF916-X2-U,UF926-X2-U	49
HSH-12-15MM(410M2)	MITSUBISHI	LU2-4412-B1T,LU2-4430-B1T LU2-4650-B1T,LU2-4710-B1T	49
HSH-12-15MM(5)	BROTHER	LT2-B837	49
	PRINCE	PLM-100	
	SEIKO	LLW-28L-TA,LLW-8BL,LLW-8L-TA LLW-8L-TA,LSW-26BL,LSW-6L LSW-7BL-T,LSW-7L-T,LSW-8BL LSW-8BLV,LSW-8L,LSW-8LV,LSW-8LVMF	
	SUNSTAR	KM-560	
	NITAKA	TC-2508,TC-28B,TC-8B	
HSH-12-15MM(5)SS	TOYOTA	AD331L,AD332LP	49
HSH-12-15MM(5)TR1	BROTHER	LT2-B837-300	49
HSH-12-15MM(A)		with short hook gib	49
HSH-12-15MM(V)	MITSUBISHI	LU2-400-BOB,LU2-4400	49
	HIGHLEAD	GC20618-1,GC20618-2	
	WANPING	GC20606	
	GOLDEN WHEEL	CS3L-7241,CSU-4101	
HSH-12-15MMB(5)	BROTHER	LT2-B838	49
	SEIKO	LLW-28,LLW-28BL,LSW-27BL,LSW-27L LSW-28BL,LSW-28L,LTW-27BLM	
HSH-12-15MMB(5)TR1	BROTHER	LT2-B837-300	49
HSH-12-15MMB(5)TR4	TOYOTA	AD3110,AD3310,AD3320	49
	SUNSTAR	KM-560-7	
HSH-12-15MMJ	JUKI	LU-1508NS,LU-1510N,LU-1560N,LU-563	49
HSH-12-15MMJ(A)	JUKI	LU-1508NH,LU-563-3	49
	SINGER	211U867,211UX567,212U539A/839A	
HSH-12M(3)	MITSUBISHI	LU2-430-B1T,LU2-4410-B1T	49
HSH-12M(BR)	BROTHER	LT2-B882	49
HSH-12M-82C(L)	JUKI	LH-1182 left hand	50
HSH-12M-82C(R)	JUKI	LH-1182 right hand	50
HSH-12M-82CTR(L)	JUKI	LH-1182-4 left hand	50
	SHANGGONG	GD8-1,GD8-4,GD8-7	
HSH-12M-82CTR(R)	JUKI	LH-1182-4 right hand	50
	SHANGGONG	GD8-1,GD8-4,GD8-7	
HSH-12MA(3)	MITSUBISHI	LT2-4410-B1T-CS	50
HSH-12MC	MITSUBISHI	LT2-2240-BOB,PLY-501F	50
	GEMSY	2000-2B	
	HIGHLEAD	GC20518-B	
	TYPICAL	GC6240B	
	UNICORN	LT2-H625(H)	
	GOLDEN WHEEL	CS-3150-L,CS-7175,CS-875L	
	MILLION SPECIAL	MS-B875-5	
	NITAKA	TC2-B1885,TC2-B875	

VERTICAL AXIS ROTARY HOOK 水平回转式梭头
LARGE TYPE with SHAFT 长轴大型梭头

ITEM 广濑品名	APPLICATION 对应機種		PHOTO PAGE 图片
	BRAND 品牌	MODEL 机型	
HSH-12MC	SICAMA	LT2-B875,LT2-B875-5	50
HSH-12MC(1)	BROTHER	LT2-B836	50
HSH-12MC(2)	JUKI	LH-527,LUH-526	50
HSH-12MC(3)	MITSUBISHI	LT2-2250-B1T,PLK-E7191,PLY-1185 PLY-7181,PLY-7202	50
	HIGHLEAD	GC20528-B-D	
	SICAMA	LT2-B875-380,LT2-B875-580	
HSH-12MC(5)	SEIKO	LSW-26BL-R,LSW-6L-G,LSW-7L-G	50
HSH-12MCA(2)	JUKI	LU-1565N,LUH-521	50
HSH-12MCA(5)	SEIKO	LSW-27BLK,LSW-28BLK	50
※ HSH-12MM(6)TR	JUKI	LU-1510-7	50
※ HSH-12MMA(6)TR	JUKI	LU-1510N-7,LU-1560N-7	50
HSH-445	DURKOPP/ADLER	220	50
	SINGER	144W,145W	
HSH-445(6SP)	JUKI	LG-158 with special hard hook point	50
HSH-445(SP)	SINGER	144W,145W with special hard hook point	50
HSH-445-59	JUKI	LT-591	50

SHUTTLE 摆梭

ITEM 广濑品名	APPLICATION 对应機種		PHOTO PAGE 图片
	BRAND 品牌	MODEL 机型	
DD1	SINGER	45K closed frame	51
DD1(6)	YAKUMO	DD-N73,DDU-N73,DDN-738	51
DD1-OP	SINGER	45K open frame	51
HAD-204	DURKOPP/ADLER	204,205	51
	SEIKO	CH-series,TH-series	
	CHIKON	CK-1461	
HAD-204(273)	JUKI	TSC-441,TSC-461,TSH-411,TSU-471 TU-273	51
	WANPING	TW3-243,TW3-441,TW3-471	
HAD-204(6)	CHIKON	CK-243,CK-441	51
HAD-204(OP)	SEIKO	CH-series	51
HSH-1-1	SINGER	11-11	51
HSH-7-3	DURKOPP/ADLER	20,21	51
	SEIKO	SLH-series	
	SINGER	7-31/33/56	
	WANPING	733R	
	CHIKON	CK-767,SLH-2B	
※ TC-310(AF)	BROTHER	BAS-311F-01,BAS-326F-01,BAS-341F-01 BAS-341F-01	51
※ TC-310(BG)	BROTHER	BAS-311F-02,BAS-326F-02,BAS-7050	51
TC-LK(BUC)	UNICORN	UAS-H1407(H)	51
TC-LK(SUA)	SUNSTAR	SPS/A-1306(GS)	51
TC-LK(SUB)	SUNSTAR	SPS/A-1306(HS)	51
TF1	DURKOPP/ADLER	48	51
	SEIKO	TE-series,TF-series	
	SINGER	17,18U	

OTHERS 其他

ITEM 广瀬品名	APPLICATION 对应機種		PHOTO PAGE 图片
	BRAND 品牌	MODEL 机型	
※ HAD-467CTR(SU)	SUNSTAR	KM-1060BL-7	52
HAD-467TR	DURKOPP/ADLER	467	52
	SHIANG WANG	WR-467	
HAD-467TR(1B)	BROTHER	LS2-B891,LT2-B892	52
	SEIKO	BEW-series,BBW-series	
	SUNSTAR	KM-1060BL	
	SIRUBA	UF918-X2,UF928-X2	
※ HAD-467TR(6A)	JUKI	LU-2210N-7,LU-2260N-7	52
※ HAD-M467TR(6)	JUKI	LU-2210W-7,LU-2260W-7	52
HBA-1	BARATTO	for scalloping machine	52
HLE-16	UNION SPECIAL	16	52
HLE-16(170UN)	UNION SPECIAL	16	52
HLE-170	TREASURE	BS-1700,BS-170C,BS-170LA,BS-170PB BS-170SF,BS-171,BS-172	52
	UNION SPECIAL	170	
HLE-30(UN)	UNION SPECIAL	30	52
※ HMU-1	MAMMUT	quilting machine	52
HSH-32	DURKOPP/ADLER	265	52
	MITSUBISHI	DY-253	
	SEIKO	SK-series	
	SINGER	132K	
	WANPING	SK-2B	
HSH-32(26)	SEIKO	SKM-26,36	52
HSH-33	SEIKO	CK-1	52
	SINGER	133K	
HSH-33(3)	MITSUBISHI	PLK-2020	52
HTT-12(21)		for tatami overedging machine	52
HTT-18		for tatami overedging machine	52
HTT-20		for tatami overedging machine	52
HTT-21(K)		for tatami overedging machine	52
KN-SCT		knife for carpet machine	52
L-BQ1U	BROTHER	BM-917B-00,CB3-B916A,917A	52
	JUKI	MB-372~373	
	YAMATO	NB-2000,NB-2050	
L-BSR(503)			52
L-BTM(5/32)		for British tufting machine	52
L-CS2	SINGER	55-20	52
RE-DP855		bobbin case stop	52

BOBBIN CASE / CAP 梭芯套/梭帽

ITEM 广濑品名	APPLICATION 对应機種		PHOTO PAGE 图片
	BRAND 品牌	MODEL 机型	
BC-102	SINGER	107W100/102/103	53
※ BC-12L(TR2FB)	JUKI	for non-rotational bobbin hook	53
※ BC-310(ANC)	BROTHER	BAS-311F-02,BAS-326F-02,BAS-7050	53
※ BC-310(AND)	BROTHER	BAS-311F-01,BAS-326F-01,BAS-7050	53
※ BC-DB1(MFB)2	JUKI	for non-rotational bobbin hook	53
BC-DP2	SINGER	107W5/17	53
BC-DP2(2)	DURKOPP/ADLER	91,252,264	53
	JUKI	LBH-761~3	
	PEGASUS	DPS-2,DPS-3,DPS-4	
	SINGER	107G,107W1/3/5/17,151W	
	YAMATO	DP-2,DP-3	
	SHANGGONG	G15	
	SUNSTAR	DPK-2	
BC-DP2(3B)	BROTHER	LH4-B814,LH4-B817	53
BC-DP57	JUKI	LZ-1280	53
	SINGER	457A,457G,457U	
	STAGER	SZ-310-3N,SZ-310-4N,SZ-310-5-1N,SZ-310-11N	
	YAMATO	LG2125 LD,LG2125 LE,LG2125 LW	
	JACK	JK457	
	ZOJE	GG457,ZJ457A135,ZJ457A125/105	
	YULUN	475A-505-PBG-NHL,475A-605-NCB-LG,YHL-205M-NCB	
BC-DP800	BROTHER	HE-8000-2,HE-8000-3,HE-8000-5,HM-8180	53
	SUNSTAR	BH/3000	
BC-DP815	BROTHER	BAS-511,LH4-B816 whip stitch	53
BC-DP815(P)	BROTHER	BAS-511,LH4-B816 purl stitch	53
BC-DP855	BROTHER	ZE-855A,ZE-8570	53
	SUNSTAR	KM-2070	
BC-DP856	BROTHER	ZE-856A,ZE-8580	53
	SUNSTAR	KM-2077	
BC-HBA1	BARATTO	for scalloping machine	53
BC-HDU551	DURKOPP/ADLER	551,555	53
BC-HDU556	DURKOPP/ADLER	556	53
BC-HPF3114	PFAFF	3114~3116	53
BC-HST(2)	JUKI	LK-1941、1942	53
BC-HST(A1)	BROTHER	LK3-B484(KE-484C)	53
BC-HST(B1)	BROTHER	KE-484C-X,LK3-B484(KE-484C)	53
BC-HTH(2E)	JUKI	AVP-875A	53
※ BC-HTH(2EA)	JUKI	DLN-6390-7	53
BC-HTH(E)		for HTH-series hook	53
※ BC-HTH(HPNG)	BROTHER	BAS-7610,DB3-B775,DB3-B776,SC-7760-705	53
BC-HTH(ZE)	UNICORN	TZ1-B652XH	53
BC-HTH(ZEH)	SWF	SWF/B-UK1202-45,SWF/B-UK1204-45 SWF/B-UK1206-45	53
BC-HTM(761)	BROTHER	BAS-761,BAS-7610	53
BC-HTT12(21)		for tatami overedging machine	53
BC-HTT18		for tatami overedging machine	53
BC-HTT20		for tatami overedging machine	53

BOBBIN CASE / CAP 梭芯套/梭帽

ITEM 广濑品名	APPLICATION 对应機種		PHOTO PAGE 图片
	BRAND 品牌	MODEL 机型	
BC-HTT21(K)		for tatami overedging machine	53
BC-TCLK(B)	SUNSTAR	SPS/A-1306(GP),SPS/A-1306(GS),SPS/A-1306(HS)	53
	UNICORN	UAS-H1407(H)	
CP-12(2)	JUKI	LH-1152,LH-1152-4	54
CP-12(3)	mitsubishi	LX2-630-M1	54
CP-12(570TC)	JUKI	APW-192N~196N,APW-231N~239N APW-297,298,LH-570, 571	54
CP-12C	BROTHER	LT2-B835	54
	MITSUBISHI	LT2-2240-MOB,LT2-2250-M1TW	
	SEIKO	LTW-27BK	
	SINGER	212U143A/144,212U443A/444	
	GEMSY	2000-2M	
	HIGHLEAD	GC20528-M	
	TYPICAL	GC6240M,GC6240MD	
	UNICORN	LT2-H625(M)	
	GOLDEN WHEEL	CS-3150,CS-7165,CS-875-3	
	MILLION SPECIAL	MS-B845	
	NITAKA	TC2-B845,TC2-B1883	
CP-12CTR	BROTHER	LT2-B835-3-0	54
CP-12CTR(1)	BROTHER	LT2-B845-380	54
CP-12L(1)	BROTHER	LT2-B832-1,-3,-5	54
CP-12L(1)TR1	BROTHER	LT2-B832-3-0	54
CP-12M(230)	MITSUBISHI	LU2-430-B1T,LU2-4410-B1T,PLK-E7191 PLY-1185,PLY-7181	54
CP-12MC	JUKI	LH-527,LU-1565N,LUH-521,LUH-526	54
	MITSUBISHI	LT2-2240-BOB,PLY-501F	
	GEMSY	2000-2B	
	HIGHLEAD	GC20518-B	
	TYPICAL	GC6240B	
	UNICORN	LT2-H625(H)	
	GOLDEN WHEEL	CS-3150-L,CS-7175,CS-875L	
	MILLION SPECIAL	MS-B875-5	
	NITAKA	TC2-B875,TC2-B1885	
CP-12MC(1)	BROTHER	LT2-B836	54
CP-12MC(3)	MITSUBISHI	LT2-2250-B1T	54
	HIGHLEAD	GC20528-B-D	
	GOLDEN WHEEL	CS-7175-BT,CS-7175H-BT	
	SICAMA	LT2-B875-380,LT2-B875-580	
CP-12MC(5)	SEIKO	LSW-26BL-R,LSW-27BLK,LSW-6L-G	54
CP-12MC(S)	SINGER	212U543A/544,212U843A	54
CP-18	SINGER	51W,136W,236W	54
CP-2	SINGER	21W162,22W	54
CP-21(2)	JUKI	LH-525N,LH-529	54
CP-212	SINGER	211G451/457,212G140/141/145/440,212U441	54
CP-62C	JUKI	LH-1162,LH-1162-4	54
CP-68	SINGER	112W115-139,138G101,167G/W	54
CP-G12C	BROTHER	LT2-B845,T-8450A-003,TN-845A-003	54
	GEMSY	845	

※: EXCLUSIVE SELLING ITEM

From the library of: YSM Japan

BOBBIN CASE / CAP 梭芯套/梭帽

ITEM 广濑品名	APPLICATION 对应機種		PHOTO PAGE 图片
	BRAND 品牌	MODEL 机型	
CP-G12C	JACK	JK5845-3	54
	TYPICAL	GC6845H	
	WANPING	TW2-B845-5	
	ZOJE	845	
	SIRUBA	T828-45-H,T828-48-L	
CP-G12C(2)	JUKI	LH-3162-7,LH-3168,LH-3168-7	54
	SUNSTAR	KM-790,KM-790-7	
CP-G12C(2SU)	UNICORN	LT2-H6250(M)	54
CP-G12CTR(1)	BROTHER	LT2-B845,T-8452A-403,TN-845B-401	54
	JACK	JK5845-5	
	PROTEX	TY-B845-403	
	TYPICAL	GC6845HD3,GC6845MD3	
	WANPING	845	
	ZOJE	845-D3	
	SICAMA	BEISLER 845,YAZICI 845	
	SIRUBA	T828-45-H-U,T828-45-M-U,T828-48-L-U	
CP-G12L(1)	BROTHER	LT2-B841,LT2-B842,T-8421A-T03,TN-842B-40F	54
	TYPICAL	GC6842HD3,GC6842MD3	
	SICAMA	BEISLER 842,YAZICI 842	
	SIRUBA	T828-41,T828-42,T828-47	
CP-G12L(2)	JUKI	LH-3128,LH-3128-7	54
CP-G12M(2)TR	JUKI	LH-3178	54
CP-G12M(BR)TR	BROTHER	LT2-B872,T-8722A-403,TN-872B-403	54
	GEMSY	872-7	
	JACK	JK5872-5,JK5875-5	
	WANPING	872	
	ZOJE	872-D3	
	MILLION SPECIAL	MS-B872-403,MS-B872-405	
	NITAKA	TC-B872-403,TC-B872-405	
	SIRUBA	T828-72-H-U,T828-72-M-U	
CP-G12MC(1)	BROTHER	BAS-612,613,LT2-B875,T-8750A-003,TN-875A-003	54
	GEMSY	875	
	JACK	JK5875-3	
	PROTEX	TY-B875-5	
	TYPICAL	GC6875H,GC6875M	
	WANPING	TW2-B875	
	ZOJE	875	
	SIRUBA	T828-75H,T828-75M,T828-75X	
CP-G12MC(1)TR	BROTHER	BAS-6150,BAS-6200,LT2-B875,T-8752A-403	54
	GEMSY	875-7	
	TYPICAL	GC6872MD3,GC6875HD3,GC6875MD3	
	WANPING	875	
	ZOJE	875-D3	
	SUNSTAR	KM-790BL,KM-790BL-7	
	UNICORN	LT2-H6250(H)	
	MILLION SPECIAL	MS-B875-3,MS-B875-403,MS-B875-405	
NITAKA	TC-B875-403,TC-B875-405		

※ : EXCLUSIVE SELLING ITEM

BOBBIN CASE / CAP 梭芯套/梭帽

ITEM 广濑品名	APPLICATION 对应機種		PHOTO PAGE 图片
	BRAND 品牌	MODEL 机型	
CP-G12MC(1)TR	SICAMA	LT2-B872-580	54
	SIRUBA	T828-75-H-U,T828-75-M-U,T828-75-X-U	
CP-G12MC(2)	JUKI	LH-3178-7,LH-3188,LH-3188-7	54
CP-HAD161(6)	JUKI	PLC-1610,PLC-1660,PLC-1690A	54
CP-HAD167	DURKOPP/ADLER	167,267,268	55
CP-HAD167(6)	JUKI	PLC-1660L	55
CP-HAD167CTR	JUKI	PLC-1665	55
CP-HAD167TR	DURKOPP/ADLER	167-FA272,167-FA272NH,267-FA	55
CP-HAD267TR	DURKOPP/ADLER	268-FA	55
	JUKI	PLC-1610-7,PLC-1660-7	
※ CP-HAD467TR	SUNSTAR	KM-1060BL-7	55
CP-HAD68	DURKOPP/ADLER	67,68	55
CP-HAD68(6)	JUKI	PLC-1691	55
CP-HDU249	DURKOPP/ADLER	221,249,380	55
CP-HDU381	DURKOPP/ADLER	380	55
CP-HPF1242TR	PFAFF	1244-720-900,1246-900	55
CP-HPF144TR	PFAFF	144	55
	SEIKO	PWB-8GWC,PWB-8GWC-FL,PWB-8GWC-LC	
	SUNSTAR	KM-867-7	
	UNICORN	LT5-H7200/H7600	
	GOLDEN WHEEL	CS-6111B,CS-6112B	
	MILLION SPECIAL	MS-491-830,MS-674-530	
	SHIANG WANG	WR-9910-T,WR-9920-T	
	SIRUBA	R718-01-U,R728-U	
	TAKING	TK-591T,TK-691T	
CP-HPF151	PFAFF	141~146,151,191~196	55
	SEIKO	PWB-8GW,PWB-8W	
	HIGHLEAD	GC24618,GC24618-1	
	WANPING	GC24660,GC24680,PWB-8GW	
	SUNSTAR	KM-957	
	GOLDEN WHEEL	CS-861,CS-8810	
	MILLION SPECIAL	MS-474-500,MS-674-500,MS-691-800	
	NITAKA	TC-881,TC-882	
	SHIANG WANG	WR-9910-1,WR-992	
TAKING	TK-591,TK-691,TK-991		
CP-HPF151TR	PFAFF	142-720-900,142-721-900,142-900	55
CP-HPF190	MITSUBISHI	LX5-871-MO	55
	PFAFF	190,390	
CP-HPF442TR	PFAFF	441-900~448-900	55
CP-HPF490	PFAFF	471-900~493-900	55
CP-HPF545	JUKI	LS-1341,LS-341N-7	55
	PFAFF	1242-720,541~546,551~555	
	WANPING	1245,TW3-341	
	FENG YING	FY-341	
	MILLION SPECIAL	MS-1245	
	NITAKA	TC-1341	
	TAKING	TK-545,TK-1245,TK-1246	

※ : EXCLUSIVE SELLING ITEM



























BOBBIN CASE / CAP 梭芯套/梭帽

ITEM 广濑品名	APPLICATION 对应機種		PHOTO PAGE 图片
	BRAND 品牌	MODEL 机型	
CP-HPF545	YULUN	YLM-545,YLM-1245,YLM-1246	55
CP-M82C	JUKI	LH-1182,LH-1182-4	55
	SHANGGONG	GD8-1,GD8-4,GD8-7	





HORIZONTAL AXIS ROTARY HOOK(DB TYPE) HIGH SPEED TYPE 垂直回转式梭头(DB型) 高速缝梭头

HAD-396  φ 7.24	HAD-396(H)  φ 7.24	HDU-211  φ 7.24	HDU-211(1)  φ 7.24
HDU-271  φ 7.24	HDU-272  φ 7.24	※ HDU-271(QRP)  φ 7.24 <small>Oil free hook</small>	HNE-830  φ 7.24
HNE-835  φ 7.24	HPF-480  φ 7.24	HSH-7.24BJ  φ 7.24	HSH-7.24BJZ  φ 7.24
HSH-7.94A  φ 7.94	HSH-7.94A(3)  φ 7.94	HSH-7.94A(TS)  φ 7.94 <small>With teflon base</small>	HSH-7.94A1  φ 7.94
HSH-7.94A0  φ 7.94	HSH-7.94A0TR  φ 7.94	HSH-7.94ATR  φ 7.94	HSH-7.94B  φ 7.94
HSH-7.94B(1)  φ 7.94	HSH-7.94B(1)TR  φ 7.94	※ HSH-7.94B(2SPH)  φ 7.94	HSH-7.94B(391)  φ 7.94
HSH-7.94B(491)  φ 7.94	HSH-7.94B(660)  φ 7.94	HSH-7.94B(7)  φ 7.94	HSH-7.94B(AC)  φ 7.94

HORIZONTAL AXIS ROTARY HOOK(DB TYPE) HIGH SPEED TYPE 垂直回转式梭头 (DB 型) 高速缝梭头

<p>HSH-7.94B(HP) ϕ 7.94</p>  <p>With super hard point</p>	<p>HSH-7.94B(K) ϕ 7.94</p> 	<p>HSH-7.94B(KSN) ϕ 7.94</p> 	<p>HSH-7.94B(NK) ϕ 7.94</p> 
<p>HSH-7.94B(Q) ϕ 7.94</p> 	<p>HSH-7.94B(RT) ϕ 7.94</p> 	<p>HSH-7.94B(SPH) ϕ 7.94</p> 	<p>HSH-7.94B(SPHA) ϕ 7.94</p> 
<p>HSH-7.94B(TS) ϕ 7.94</p>  <p>With teflon base</p>	<p>HSH-7.94B1 ϕ 7.94</p> 	<p>HSH-7.94BKTR ϕ 7.94</p> 	<p>HSH-7.94BKTR(2) ϕ 7.94</p> 
<p>HSH-7.94BKTR(H) ϕ 7.94</p> 	<p>HSH-7.94BN ϕ 7.94</p> 	<p>HSH-7.94BO ϕ 7.94</p> 	<p>HSH-7.94BOH ϕ 7.94</p> 
<p>HSH-7.94BOH(1) ϕ 7.94</p> 	<p>HSH-7.94BOHN ϕ 7.94</p> 	<p>HSH-7.94BOHN(1) ϕ 7.94</p> 	<p>HSH-7.94BOHNTR ϕ 7.94</p> 
<p>HSH-7.94BOHNTR(B) ϕ 7.94</p> 	<p>HSH-7.94BRN ϕ 7.94</p> 	<p>HSH-7.94BRN(H) ϕ 7.94</p> 	<p>HSH-7.94BSN ϕ 7.94</p> 
<p>HSH-7.94BTR ϕ 7.94</p> 	<p>※HSH-7.94BTR(1RPWL) ϕ 7.94</p>  <p>Oil free hook</p>	<p>※HSH-7.94BTR(2QSP) ϕ 7.94</p> 	<p>※HSH-7.94BTR(2QSPFB) ϕ 7.94</p>  <p>Non-rotational bobbin hook</p>





HORIZONTAL AXIS ROTARY HOOK(DB TYPE) HIGH SPEED TYPE 垂直回转式梭头(DB型) 高速缝梭头

※ HSH-7.94BTR(2SPFB) ϕ 7.94  Non-rotational bobbin hook	※ HSH-7.94BTR(2SPRPWS) ϕ 7.94  Oil free hook	HSH-7.94BTR(3) ϕ 7.94 	HSH-7.94BTR(491) ϕ 7.94 
HSH-7.94BTR(591B) ϕ 7.94 	HSH-7.94BTR(591D) ϕ 7.94 	HSH-7.94BTR(591DT) ϕ 7.94  With titanium base	HSH-7.94BTR(737) ϕ 7.94 
HSH-7.94BTR(737SPQ) ϕ 7.94 	HSH-7.94BTR(CR) ϕ 7.94 	HSH-7.94BTR(HP) ϕ 7.94  With super hard point	HSH-7.94BTR(N) ϕ 7.94 
※ HSH-7.94BTR(PFQL) ϕ 7.94 	HSH-7.94BTR(Q) ϕ 7.94 	HSH-7.94BTR(QSP) ϕ 7.94 	HSH-7.94BTR(R) ϕ 7.94 
HSH-7.94BTR(RPW) ϕ 7.94  Oil free hook	HSH-7.94BTR(SP) ϕ 7.94 	HSH-7.94BTR(SPH) ϕ 7.94 	HSH-7.94BTR(T) ϕ 7.94 
HSH-7.94BTR(TIN) ϕ 7.94  With titanium base	HSH-7.94BTR(TS) ϕ 7.94  With teflon base	HSH-7.94C ϕ 7.94 	HSH-7.94C(L) ϕ 7.94 
HSH-7.94C(TS) ϕ 7.94  With teflon base	HSH-7.94CO ϕ 7.94 	HSH-7.94CO(L) ϕ 7.94 	HSH-7.94CO(TS) ϕ 7.94  With teflon base















HORIZONTAL AXIS ROTARY HOOK(DB TYPE) HIGH SPEED TYPE 垂直回转式梭头(DB型) 高速缝梭头

<p>HSB-7.94COTR ϕ 7.94</p> 	<p>HSB-7.94CTR ϕ 7.94</p> 	<p>HSB-7.94CTR(TS) ϕ 7.94</p>  <p>With teflon base</p>	<p>HSB-7.94D ϕ 7.94</p> 
<p>HSB-7.94DRN(1) ϕ 7.94</p> 	<p>HSB-7.94DRNTR ϕ 7.94</p> 	<p>HSB-7.94DTR(1Q) ϕ 7.94</p> 	<p>HSB-7.94DTR(Q) ϕ 7.94</p> 
<p>HTE-833 ϕ 7.24</p> 	<p>HTH-614BTR(1.7QE) ϕ 8.10</p>  <p>HTH series hook (1.7 times thread)</p>	<p>*HTH-614BTR(2E) ϕ 8.10</p>  <p>HTH series hook (1.7 times thread)</p>	<p>HTH-614BTR(QE) ϕ 8.10</p>  <p>HTH series hook (1.7 times thread)</p>
<p>HTH-ATR(E) ϕ 7.94</p>  <p>HTH series hook (1.7 times thread)</p>	<p>*HTH-BTR(2SPHPNG20E) ϕ 7.94</p>  <p>HTH series hook (1.7 times thread)</p>	<p>HTH-BTR(E) ϕ 7.94</p>  <p>HTH series hook (1.7 times thread)</p>	<p>*HTH-BTR(HPNG) ϕ 7.94</p>  <p>HTH series hook (1.7 times thread)</p>
<p>HUN-614B ϕ 8.10</p> 	<p>HUN-614B(L) ϕ 8.10</p> 	<p>HUN-614C ϕ 8.10</p> 	<p>HUN-614C(L) ϕ 8.10</p> 
<p>HUN-614C(TS) ϕ 8.10</p>  <p>With teflon base</p>			

HORIZONTAL AXIS ROTARY HOOK(DB TYPE) LARGE TYPE 垂直回转式梭头 (DB型) 大型梭头

DBL-C ϕ 7.94  <small>3 times large hook</small>	DBM-A(Z14) ϕ 7.24 	DBM-A(Z17) ϕ 7.24 	DBM-ATR(7.94) ϕ 7.94 
HDU-M265 ϕ 8.0 	HPF-3518 ϕ 7.24 	HPF-418 ϕ 7.24 	HSM-A ϕ 7.94 
HSM-A(3) ϕ 7.94 	HSM-A(5) ϕ 7.94 	HSM-A(6) ϕ 7.94 	HSM-A(M2QTS) ϕ 7.94 <small>With teflon base</small> 
HSM-A(MQ2L) ϕ 7.94 	HSM-A1 ϕ 7.94 	HSM-A1HTR ϕ 7.94 	HSM-A1HMTR ϕ 7.94 
HSM-A1HTR(T) ϕ 7.94 <small>With titanium base</small> 	HSM-A1SH ϕ 7.94 	HSM-A1TR(280) ϕ 7.94 	HSM-AM(3) ϕ 7.94 
HSM-AR(1.7) ϕ 7.94 <small>For skip-free stitching</small> 	HSM-AR(2.1) ϕ 7.94 <small>For skip-free stitching</small> 	※ HSM-AR(PNG) ϕ 7.94 <small>For skip-free stitching</small> 	HSM-ARTR(1.7) ϕ 7.94 <small>For skip-free stitching</small> 
HSM-ARTR(2.1) ϕ 7.94 <small>For skip-free stitching</small> 	※ HSM-ARTR(ABHP) ϕ 7.94 <small>For skip-free stitching With super hard point</small> 	HSM-ATR(1Q) ϕ 7.94 	HSM-ATR(1QTS) ϕ 7.94 <small>With teflon base</small> 

HORIZONTAL AXIS ROTARY HOOK (DB TYPE) LARGE TYPE 垂直回转式梭头 (DB型) 大型梭头

HSM-ATR(MQ1L) $\phi 7.94$ 	* HSM-ATR(PFNGOPTS)L $\phi 7.94$  <i>With nylon base</i>	HSM-B $\phi 7.94$ 	HSM-B(1SU) $\phi 7.94$ 
HSM-B(IE) $\phi 7.94$ 	HSM-B(Q)TR $\phi 7.94$ 	HSM-B(SU) $\phi 7.94$ 	HSM-B(Z17) $\phi 7.94$ 
HSM-B1 $\phi 7.94$ 	HSM-B1H $\phi 7.94$ 	HSM-B1H(1) $\phi 7.94$ 	HSM-B1HTR $\phi 7.94$ 
HSM-B1HTR(1Q) $\phi 7.94$ 	HSM-B1HTR(2) $\phi 7.94$ 	* HSM-B1HTR(BB) $\phi 7.94$ 	HSM-BRTR(1.7) $\phi 7.94$  <i>For skip-free stitching</i>
HSM-BRTR(2.1) $\phi 7.94$  <i>For skip-free stitching</i>	* HSM-BRTR(HP370) $\phi 7.94$  <i>For skip-free stitching With special hard point</i>	HSM-Z17 $\phi 7.94$ 	HST-A $\phi 7.94$  <i>3 times large hook</i>
HST-A(C) $\phi 7.94$  <i>3 times large hook</i>	HST-A(CNG) $\phi 7.94$  <i>3 times large hook</i>	* HST-A(HPQC) $\phi 7.94$  <i>With super hard point 3 times large hook</i>	HST-A(LP) $\phi 7.94$  <i>3 times large hook</i>
* HST-A(ME) $\phi 7.94$  <i>3 times large hook</i>	* HST-B1(HPA) $\phi 7.94$  <i>With super hard point 3 times large hook</i>	HTM-A $\phi 7.94$  <i>HTM series hook (1.4 times thread)</i>	HTM-A1HTR $\phi 7.94$  <i>HTM series hook (1.4 times thread)</i>

HORIZONTAL AXIS ROTARY HOOK(DB TYPE) LARGE TYPE

垂直回转式梭头(DB型) 大型梭头

※HTM-BTR(HP761) $\phi 7.94$













With super
hard point

HTM series hook (1.4 times thread)

<p>※HTM-BTR(HP761) $\phi 7.94$</p>  <p>With super hard point</p> <p>HTM series hook (1.4 times thread)</p>			

HORIZONTAL AXIS ROTARY HOOK(DB TYPE) LOW SPEED TYPE 垂直回转式梭头(DB型)低速缝梭头

DA1-A  φ 7.24	DA1-A(7.94)  φ 7.94	DA1-A(7.94ST)  φ 7.94	DA1-A1  φ 7.24
DA1-AH  φ 7.24	DA1-ATR  φ 7.24	DA1-ATR(1QB)  φ 7.24	DA1-B  φ 7.24
DA1-B(109)  φ 7.24	DA1-B(7.94)  φ 7.94	DA1-B(K)  φ 7.24	DA1-BOH(AL)  φ 7.24
DA1-BTR  φ 7.24	DA1-C  φ 7.24	DA1-C(AL)  φ 7.24	DA1-CTR  φ 7.24
DA2-A(TA1-A)  φ 5.53	DA2-B(TA1-B)  φ 5.53	DA2-C(TA1-C)  φ 5.53	DB1-BZ(20)  φ 7.24
DB1-BZ(20L)  φ 7.24	DB1-Z(20)  φ 7.24	DB1-Z(20L)  φ 7.24	DB1-Z16  φ 7.24
DB1-Z16(LP)  φ 7.24	DB1-Z16(TS)  φ 7.24	DB1-Z16(TU)  φ 7.24	DB1-Z16B  φ 7.24

With teflon base.

HORIZONTAL AXIS ROTARY HOOK(DB TYPE) LOW SPEED TYPE 垂直回转式梭头(DB型) 低速缝梭头

DB1-Z39  Jam proof hook	φ 7.24	DB1-Z710  Jam proof hook	φ 7.24	HDU-265 	φ 7.24	HDU-265Y 	φ 7.24
HM2-F10(EL)  Jam proof hook	φ 7.24	HM2-FATR(1)  Jam proof hook	φ 7.24	HM2-FBTR(SS)  Jam proof hook	φ 7.24	HPF-134 	φ 7.24
HPF-230W 	φ 7.24	HPF-234 	φ 7.24	HPF-238 	φ 7.24	HPF-335 	φ 7.24
HPF-335(5) 	φ 7.24	HPF-438 	φ 7.24	HPF-438(CR) 	φ 7.24	HPF-563TR(RP)  Oil free hook	φ 7.24
HSH-7.94A(M1Q) 	φ 7.94	HSH-7.94A(M1QTS)  With teflon base	φ 7.94	HSH-7.94A(M3Q) 	φ 7.94	HSH-7.94A(MTQ) 	φ 7.94
HSH-7.94ATR(M1Q) 	φ 7.94	HSH-7.94ATR(M1QH) 	φ 7.94	HSH-7.94ATR(M1QTS)  With teflon base	φ 7.94	HSH-7.94ATR(M1QTSL)  With teflon base	φ 7.94
HSH-7.94ATR(M3Q) 	φ 7.94	HSH-7.94ATR(MQ2) 	φ 7.94	HSH-7.94ATR(MQRP)  Oil free hook	φ 7.94	HSH-7.94ATR(MQRPW)  Oil free hook	φ 7.94

HORIZONTAL AXIS ROTARY HOOK(DB TYPE) LOW SPEED TYPE 垂直回转式梭头(DB型)低速缝梭头

※ HSH-7.94ATR(MQSU) ϕ 7.94



※ HSH-7.94ATR(MQSUL) ϕ 7.94



※ HSH-7.94ATR(MQSUNL) ϕ 7.94



HSH-7.94ATR(MTQ) ϕ 7.94



※ HSH-7.94ATR(MTQEL) ϕ 7.94



※ HSH-7.94ATR(MTQETA) ϕ 7.94



HSH-7.94ATR(MTQRP) ϕ 7.94



HSH-7.94ATR(MTQTS) ϕ 7.94



Oil free hook

With teflon base

HSH-7.94B(188UL) ϕ 7.94



HSM-ATR(MQRPLN) ϕ 7.94



Oil free hook

HSM-ATR(MTQ) ϕ 7.94



HSM-ATR(MTQTS) ϕ 7.94



With teflon base

HTH-ATR(MQE) ϕ 7.94



HTH series hook (1.7 times thread)

※ HTH-ATR(MQESU) ϕ 7.94



HTH series hook (1.7 times thread)

※ HTH-ATR(MQESUL) ϕ 7.94



HTH series hook (1.7 times thread)

※ HTH-ATR(MQESUNL) ϕ 7.94































HTH series hook (1.7 times thread)

TA1-Z16 ϕ 5.53



HORIZONTAL AXIS ROTARY HOOK(DP TYPE) HIGH SPEED ZIGZAG TYPE 垂直回转式梭头(DP型) 高速人字型缝梭头

DP2  With super hard point	φ 7.93	DP2(B)  With long point With super hard point	φ 7.93	DP2(H)  With titanium base	φ 7.93	DP2(HS) 	φ 7.93
DP2-457(HP)  With super hard point	φ 7.94	DP2-457(LHP)  With long point With super hard point	φ 7.94	DP2-457U(T)  With titanium base	φ 7.94	DP2-457UTR 	φ 7.94
DP2-57(2)  With long point	φ 7.94	DP2-57(2)IN  With long point	φ 7.94	DP2-57(2HPTS)  With teflon base With super hard point	φ 7.94	DP2-57(2LP)  With long point	φ 7.94
DP2-57(2LPA)  With long point	φ 7.94	DP2-57(2LPRP)  With long point Oil free hook	φ 7.94	DP2-57(2LPY)  With long point	φ 7.94	DP2-57(2RP)  Oil free hook	φ 7.94
DP2-57(3LP)  With long point	φ 7.94	DP2-57(3LP2)  With long point	φ 7.94	DP2-57(3LP2R)  With titanium base With long point	φ 7.94	DP2-57(3LP2RHP)  With titanium base With long point With super hard point	φ 7.94
* DP2-57(3LP2V)  With titanium base With long point	φ 7.94	* DP2-57(3LP2VHP)  With titanium base With long point With super hard point	φ 7.94	* DP2-57(3LP2VRPW)  Oil free hook With long point	φ 7.94	DP2-71 	φ 7.93
DP2-800FR  With long point	φ 7.94	DP2-815  With long point	φ 7.94	DP2-815(FR)  With long point	φ 7.94	DP2-816 	φ 7.94

HORIZONTAL AXIS ROTARY HOOK(DP TYPE) HIGH SPEED ZIGZAG TYPE 垂直回转式梭头(DP型) 高速人字型缝梭头

<p>DP2-816(FR) ϕ 7.94</p> 	<p>DP2-817 ϕ 7.93</p> 	<p>DP2-818FR ϕ 7.94</p> 	<p>DP2-855 ϕ 7.94</p>  <p>With titanium base</p>
<p>DP2-856TR ϕ 7.94</p>  <p>With titanium base</p>	<p>DP2-L(N) ϕ 7.93</p> 	<p>DP2-LB ϕ 7.93</p> 	<p>DP2-NJ ϕ 7.94</p> 
<p>DP2-NJ(790) ϕ 7.94</p> 	<p>DP2-NJ(791K) ϕ 7.94</p> 	<p>DP2-NJ771 ϕ 7.94</p> 	<p>HDU-556 ϕ 8.0</p> 
<p>HPF-3114 ϕ 7.94</p> 	<p>HPF-3116 ϕ 7.94</p> 	<p>HSH-102 ϕ 7.93</p> 	<p>HSH-51-1 ϕ 7.94</p> 
<p>HSH-8-20 ϕ 6.35</p> 	<p>HSH-8-20(K) ϕ 6.35</p> 		

VERTICAL AXIS ROTARY HOOK STANDARD TYPE with SHANK

水平回转式梭头 短轴小型梭头

HAD-68	φ7.94	HDU-249	φ7.93	HPF-151	φ7.92	HPF-442	φ7.92
							
HPF-442TR	φ7.92	HPF-442TR(L)	φ7.92	HPF-490	φ7.92	HPF-490(5)TR	φ7.92
							
HPF-490(A)	φ7.92	HPF-490A(5)TR	φ7.92	HPF-490A(N)	φ7.92	HPF-490AH(N)	φ7.92
							
HPF-490TR	φ7.92	HSH-10-100	φ7.93	HSH-10-100A	φ7.93	HSH-10-100M	φ7.93
							
HSH-18-4	φ7.93	HSH-18-4A	φ7.93	HSH-18-4C	φ7.93	HSH-19	φ7.93
							
HSH-2-12	φ7.93	HSH-22-21	φ7.93	HSH-31	φ7.93	HSH-31(12)	φ7.93
							
HSH-31(6)	φ7.93	HSH-31(B)	φ7.93	HSH-31(B12)	φ7.93	HSH-36-1	φ7.93
							

VERTICAL AXIS ROTARY HOOK STANDARD TYPE with SHAFT

水平回转式梭头 长轴小型梭头









H12-15L $\phi 9.52$ 	H12-15L(TR2) $\phi 9.52$ 	※ H12-15L(TR2AE) $\phi 9.52$ 	※ H12-15L(TR2FB) $\phi 9.52$  Non-rotational bobbin hook
H12-15LC $\phi 9.52$ 	H12-15LCTR2 $\phi 9.52$ 	H12L(1) $\phi 9.52$ 	HG12-15L $\phi 9.52$ 
HG12-15L(H) $\phi 9.52$ 	HG12-15L(TR1) $\phi 9.52$ 	HG12-15LC $\phi 9.52$ 	HG12-15LCTR1 $\phi 9.52$ 
HG12L(1) $\phi 9.52$ 	HG12L(1)TR1 $\phi 9.52$ 	HR12-15L $\phi 9.52$ 	HR12-15L(H) $\phi 9.52$ 
HR12-15L(TR1) $\phi 9.52$ 	HR12-15LC $\phi 9.52$ 	HR12-15LCTR1 $\phi 9.52$ 	HR12L(1) $\phi 9.52$ 
HR12L(1)TR1 $\phi 9.52$ 	HSH-11-51 $\phi 7.94$ 	HSH-11-53 $\phi 9.52$ 	HSH-11-55 $\phi 9.52$ 
HSH-11-55M(2) $\phi 9.52$ 	HSH-12(2) $\phi 9.52$ 	HSH-12(2)TR $\phi 9.52$ 	HSH-12(570) $\phi 9.52$ 

VERTICAL AXIS ROTARY HOOK STANDARD TYPE with SHAFT

水平回转式梭头 长轴小型梭头

HSH-12-11M $\phi 9.52$ 	HSH-12-15 $\phi 9.52$ 	HSH-12-15(2) $\phi 9.52$ 	HSH-12-15(2)TR $\phi 9.52$ 
HSH-12-15(A) $\phi 9.52$ 	HSH-12-15L $\phi 9.52$ 	HSH-12-15L(H) $\phi 9.52$ 	HSH-12-15L(TR) $\phi 9.52$ 
HSH-12-15L(TR1) $\phi 9.52$ 	HSH-12-15LC $\phi 9.52$ 	HSH-12-15LCTR $\phi 9.52$ 	HSH-12-15LCTR1 $\phi 9.52$ 
HSH-12-15LTR(H) $\phi 9.52$ 	HSH-12-15M $\phi 9.52$ 	HSH-12-15M(3) $\phi 9.52$ 	HSH-12-15M(3UC) $\phi 9.52$ 
HSH-12-15MTR $\phi 9.52$ 	HSH-12-15MTR(3) $\phi 9.52$ 	HSH-12-40 $\phi 7.94$ 	HSH-12-62C(L) $\phi 9.52$ 
HSH-12-62C(R) $\phi 9.52$ 	HSH-12-62CTR(L) $\phi 9.52$ 	HSH-12-62CTR(R) $\phi 9.52$ 	HSH-12-68 $\phi 7.94$ 
HSH-12C $\phi 9.52$ 	HSH-12L(1) $\phi 9.52$ 	HSH-12L(1)TR $\phi 9.52$ 	HSH-12L(1)TR1 $\phi 9.52$ 

VERTICAL AXIS ROTARY HOOK STANDARD TYPE with BOSS(HUB) 水平回转式梭头 轴套小型梭头

<p>HSH-21-40 $\phi 8.01$</p> 	<p>HSH-21-40(2) $\phi 8.01$</p> 	<p>HSH-21-40(AJ) $\phi 8.01$</p> 	<p>HSH-21-40(HP) $\phi 8.01$</p>  <p><small>With super hard point</small></p>
<p>HSH-21-40(J) $\phi 8.01$</p> 	<p>HSH-21-40(S)C $\phi 8.01$</p> 	<p>HSH-21-40A(2) $\phi 8.01$</p> 	<p>HSH-21-40TR $\phi 8.01$</p> 
<p>HUN-622 $\phi 9.52$</p> 			

VERTICAL AXIS ROTARY HOOK LARGE TYPE with SHANK

水平回转式梭头 短轴大型梭头

HAD-160(1341A) $\phi 7.94$ 	HAD-160(6) $\phi 7.94$ 	HAD-160TR(6) $\phi 7.94$ 	HAD-161(6) $\phi 7.94$ 
HAD-166TR $\phi 7.94$ 	HAD-167 $\phi 7.94$ 	HAD-167TR $\phi 7.94$ 	HAD-267TR $\phi 7.94$ 
HPF-1242 $\phi 7.91$ 	HPF-1242(A) $\phi 7.91$ 	HPF-1242(A)TR $\phi 7.91$ 	HPF-1242TR $\phi 7.91$ 
HPF-545 $\phi 7.91$ 	HSH-12MS $\phi 7.92$ 	HSH-12MS(5) $\phi 7.92$ 	HSH-12-15MM(S) $\phi 7.92$ 
HSH-12-15MM(S)C $\phi 7.92$ 	HSH-31MMB(5) $\phi 7.93$ 	HYM-1341ATR(6) $\phi 7.94$ 	HYM-1341AY $\phi 7.94$ 
HYM-1341AY(6) $\phi 7.94$ 	HYM-1341BTR(6) $\phi 7.94$ 	HYM-1341BY $\phi 7.94$ 	HYM-1341BY(6) $\phi 7.94$ 

VERTICAL AXIS ROTARY HOOK LARGE TYPE with SHAFT

水平回转式梭头 长轴大型梭头

H12M-78TR $\phi 9.52$ 	H12MC(2) $\phi 9.52$ 	H12MC(2)TR $\phi 9.52$ 	H12MM(2) $\phi 9.52$ 
H12MM(2)TR $\phi 9.52$ 	HG12M(BR) $\phi 9.52$ 	HG12MC(1) $\phi 9.52$ 	HG12MC(1)TR $\phi 9.52$ 
HR12M(BR) $\phi 9.52$ 	HR12MC(1) $\phi 9.52$ 	HR12MC(1)TR $\phi 9.52$ 	HSH-12-15MM $\phi 9.52$ 
HSH-12-15MM(3)TR $\phi 9.52$ 	HSH-12-15MM(410) $\phi 9.52$ 	HSH-12-15MM(410M) $\phi 9.52$ 	HSH-12-15MM(410M2) $\phi 9.52$ 
HSH-12-15MM(5) $\phi 9.52$ 	HSH-12-15MM(5)SS $\phi 9.52$ 	HSH-12-15MM(5)TR1 $\phi 9.52$ 	HSH-12-15MM(A) $\phi 9.52$ 
HSH-12-15MM(V) $\phi 9.52$ 	HSH-12-15MMB(5) $\phi 9.52$ 	HSH-12-15MMB(5)TR1 $\phi 9.52$ 	HSH-12-15MMB(5)TR4 $\phi 9.52$ 
HSH-12-15MMJ $\phi 9.52$ 	HSH-12-15MMJ(A) $\phi 9.52$ 	HSH-12M(3) $\phi 9.52$ 	HSH-12M(BR) $\phi 9.52$ 

VERTICAL AXIS ROTARY HOOK LARGE TYPE with SHAFT

水平回转式梭头 长轴大型梭头

<p>HSH-12M-82C(L) $\phi 9.52$</p> 	<p>HSH-12M-82C(R) $\phi 9.52$</p> 	<p>HSH-12M-82CTR(L) $\phi 9.52$</p> 	<p>HSH-12M-82CTR(R) $\phi 9.52$</p> 
<p>HSH-12MA(3) $\phi 9.52$</p> 	<p>HSH-12MC $\phi 9.52$</p> 	<p>HSH-12MC(1) $\phi 9.52$</p> 	<p>HSH-12MC(2) $\phi 9.52$</p> 
<p>HSH-12MC(3) $\phi 9.52$</p> 	<p>HSH-12MC(5) $\phi 9.52$</p> 	<p>HSH-12MCA(2) $\phi 9.52$</p> 	<p>HSH-12MCA(5) $\phi 9.52$</p> 
<p>※ HSH-12MM(6)TR $\phi 9.52$</p> 	<p>※ HSH-12MMA(6)TR $\phi 9.52$</p> 	<p>HSH-445 $\phi 9.52$</p> 	<p>HSH-445(SP) $\phi 9.52$</p> 
<p>HSH-445-59 $\phi 9.52$</p> 			





























SHUTTLE 摆梭

DD1 	DD1(6) 	DD1-OP 	HAD-204 
HAD-204(273) 	HAD-204(6) 	HAD-204(OP) 	HSH-1-1 
HSH-7-3 	*TC-310(AF) 	*TC-310(BG) 	TC-LK(BUC) 
TC-LK(SUA) 	TC-LK(SUB) 	TF1 	

OTHERS 其他

<p>※HAD-467CTR(SU) ϕ 10.0</p>	<p>HAD-467TR ϕ 10.0</p>	<p>HAD-467TR(1B) ϕ 10.0</p>	<p>※HAD-467TR(6A) ϕ 10.0</p>
<p>※HAD-M467TR(6) ϕ 10.0</p>	<p>HBA-1 ϕ 6.35</p>	<p>HLE-16 ϕ 6.35</p>	<p>HLE-16(170UN) ϕ 6.35</p>
<p>HLE-170 ϕ 6.35</p>	<p>HLE-30(UN) ϕ 6.35</p>	<p>※HMU-1 ϕ 10.0</p>	<p>HSH-32 ϕ 10.3</p>
<p>HSH-32(26) ϕ 10.3</p>	<p>HSH-33 ϕ 10.3</p>	<p>HSH-33(3) ϕ 10.3</p>	<p>HTT-12(21) ϕ 25</p> <p>For Tatami Overedging machine</p>
<p>HTT-18 ϕ 25</p> <p>For Tatami Overedging machine</p>	<p>HTT-20 ϕ 20</p> <p>For Tatami Overedging machine</p>	<p>HTT-21(K) ϕ 25</p> <p>For Tatami Overedging machine</p>	<p>KN-SCT</p>
<p>L-BQ1U</p>	<p>L-BSR(503)</p>	<p>L-BTM(5/32)</p>	<p>L-CS2</p>
<p>RE-DP855</p>			















BOBBIN CASE / CAP 梭芯套/梭帽

BC-102 	※ BC-12L(TR2FB)  <i>For non-rotational bobbin hook</i>	※ BC-310(ANC) 	※ BC-310(AND) 
※ BC-DB1(MFB)2  <i>For non-rotational bobbin hook</i>	BC-DP2 	BC-DP2(2) 	BC-DP2(3B) 
BC-DP57 	BC-DP800 	BC-DP815 	BC-DP855 
BC-DP856 	BC-HBA1 	BC-HDU556 	BC-HPF3114 
BC-HST(2)  <i>For 3 times large hook</i>	BC-HST(A1)  <i>For 3 times large hook</i>	BC-HST(B1)  <i>For 3 times large hook</i>	BC-HTH(E)  <i>For HTH series hook (1.7 times thread)</i>
※ BC-HTH(HPNG)  <i>For HTH series hook (1.7 times thread)</i>	BC-HTH(ZEH)  <i>For HTH series hook (1.7 times thread)</i>	BC-HTM(761)  <i>For HTM series hook (1.4 times thread)</i>	BC-TCLK(B) 
BC-HTT12(21)  <i>For Tatami Overedging machine</i>	BC-HTT18  <i>For Tatami Overedging machine</i>	BC-HTT20  <i>For Tatami Overedging machine</i>	BC-HTT21(K)  <i>For Tatami Overedging machine</i>

BOBBIN CASE / CAP 梭芯套/梭帽

CP-12(2) 	CP-12(3) 	CP-12(570)TC 	CP-12C 
CP-12CTR 	CP-12CTR(1) 	CP-12L(1) 	CP-12L(1)TR1 
CP-12M(230) 	CP-12MC 	CP-12MC(1) 	CP-12MC(3) 
CP-12MC(5) 	CP-18 	CP-2 	CP-62C 
CP-68 	CP-G12C 	CP-G12C(2) 	CP-G12CTR(1) 
CP-G12L(1) 	CP-G12L(2) 	CP-G12M(2)TR 	CP-G12M(BR)TR 
CP-G12MC(1) 	CP-G12MC(1)TR 	CP-G12MC(2) 	CP-HAD161(6) 

BOBBIN CASE / CAP 梭芯套/梭帽

<p>CP-HAD167</p> 	<p>CP-HAD167(6)</p> 	<p>CP-HAD167CTR</p> 	<p>CP-HAD167TR</p> 
<p>CP-HAD267TR</p> 	<p>※CP-HAD467TR</p> 	<p>CP-HAD68</p> 	<p>CP-HDU249</p> 
<p>CP-HPF1242TR</p> 	<p>CP-HPF144TR</p> 	<p>CP-HPF151</p> 	<p>CP-HPF442TR</p> 
<p>CP-HPF490</p> 	<p>CP-HPF545</p> 	<p>CP-M82C</p> 	

REFERENCE TABLE

梭头与机种对照表

ALFA	58	NECCHI	73
ALTIN (TEXTIMA)	58	PEGASUS	73
BARATTO	58	PFAFF	74
BARUDAN	58	PRINCE	76
BROTHER	59	SEIKO	77
DURKOPP / ADLER	63	SINGER	79
HAPPY	65	STAGER	84
JANOME	65	TAJIMA	84
JUKI	66	TOYOTA	85
MAMMUT	70	TREASURE	85
MARCO	70	UNION SPECIAL	86
mitsubishi	71	YAMATO	86

CHINESE BRAND 87~98

BAOMA 宝马	GEMSY 宝石	SHANGGONG 上工
BUTTERFLY 蝴蝶	HIGHLEAD 海菱	SHEEN 盛铭
CHURCHILL 求精	HUANAN 华南	TYPICAL 标准
DADILI 大地利	JACK 杰克	TYPICAL BROTHER 兄弟标准
DALIAN 大连	JINSHI 金狮	WANPING 苑坪
FEIQI 飞球	MEIJIA 美佳	ZGM 珠光
FEIYUE 飞跃	PEMAL 良机	ZOJE 中捷
FLYINGMAN 飞人	PROTEX 通宇	
FOMAX	SANGOOD 双角	

KOREAN BRAND 99~100

SUNSTAR	SWF	UNICORN
---------	-----	---------

TAIWANESE BRAND 101~112

CHIKON 奇鋼	KERDER 客德	SICAMA 寶隆
CHUAN NENG 傅能	KING'S 王品	SIRUBA 銀箭
FANG HUNG 方宏	KINGTEX 精機	SUNNUN 信能
FENG YING 鋒穎	MILLION SPECIAL 萬特	TAKING 天王星
GOLDEN WHEEL 金輪	MITSUTOMO 三友	TONY 輝煌
JASON SEWING 貴峰	NITAKA 日高	YULUNG 友倫
JIN MING 進明	PANDA 建聯	
K-CHANCE 高機	SHIANG WANG 象王	

ALFA

MODEL 缝纫机机种	PART NO. 型号	WITH BC/CAP 配BC/CP	EX. ITEM 专卖品	HIROSE HOOK 广濑梭头		BOBBIN CASE 梭芯套	
				ITEM 品名	PAGE 页	PART NO. 型号	ITEM 品名
102	211234	○		DA1-B(109)	38	211297	BC-ALFA109
109	211234	○		DA1-B(109)	38	211297	BC-ALFA109
127	112329	○		DA1-C(AL)	38	112327	BC-DLN
127				DA1-BOH(AL)	38		BC-DLN
157	112329	○		DA1-C(AL)	38	112327	BC-DLN
157				DA1-BOH(AL)	38		BC-DLN
House hold				HM2-F10(EL)	39		BC-HR1

ALTIN (TEXTIMA)

MODEL	PART NO.	WITH BC/CAP	EX. ITEM	HIROSE HOOK		BOBBIN CASE	
				ITEM	PAGE	PART NO.	ITEM
8332	8427 0226	○		HTE-833	34	8402 0266	BC-DB1

BARATTO

MODEL	PART NO.	WITH BC/CAP	EX. ITEM	HIROSE HOOK		BOBBIN CASE	
				ITEM	PAGE	PART NO.	ITEM
				HBA-1	52		BC-HBA1

BARUDAN

MODEL	PART NO.	WITH BC/CAP	EX. ITEM	HIROSE HOOK		BOBBIN CASE	
				ITEM	PAGE	PART NO.	ITEM
BEDSH	LB220020			HSH-7.94ATR(M1QH)	39	KF220440	BC-DBZ(1)NBL6
BEDSH	KF220700			HSH-7.94ATR(M1QTS)	39	KF220440	BC-DBZ(1)NBL6
BEDSH	KF221000			HSH-7.94ATR(MQ2)	39	KF220440	BC-DBZ(1)NBL6
BEDSHE	KF220700			HSH-7.94ATR(M1QTS)	39	KF220440	BC-DBZ(1)NBL6
BEDXH	LB220020			HSH-7.94ATR(M1QH)	39	KF220440	BC-DBZ(1)NBL6
BEDYH	KF220700			HSH-7.94ATR(M1QTS)	39	KF220440	BC-DBZ(1)NBL6
BEDYH	LB220020			HSH-7.94ATR(M1QH)	39	KF220440	BC-DBZ(1)NBL6
BEDYH	KF221000			HSH-7.94ATR(MQ2)	39	KF220440	BC-DBZ(1)NBL6
BEDYHE	KF220700			HSH-7.94ATR(M1QTS)	39	KF220440	BC-DBZ(1)NBL6
BEDTHE	KF220700			HSH-7.94ATR(M1QTS)	39	KF220440	BC-DBZ(1)NBL6
BEDT-Z	KF220700			HSH-7.94ATR(M1QTS)	39	KF220440	BC-DBZ(1)NBL6

BROTHER

MODEL 缝纫机机种	PART NO. 型号	WITH BC/CAP 配 BC/CP	EX. ITEM 专卖品	HIROSE HOOK 广濑梭头		BOBBIN CASE 梭芯套	
				ITEM 品名	PAGE 页	PART NO. 型号	ITEM 品名
BAS-311F-01	SA2173-101		※	TC-310(AF)	51	S59222-101	BC-310(AND)
BAS-311F-02	SA1890-101		※	TC-310(BG)	51	S59221-101	BC-310(ANC)
BAS-311F-03	SA1890-101		※	TC-310(BG)	51	S59221-101	BC-310(ANC)
BAS-311F-L1	SA2173-101		※	TC-310(AF)	51	S59222-101	BC-310(AND)
BAS-326F-01	SA2173-101		※	TC-310(AF)	51	S59222-101	BC-310(AND)
BAS-326F-02	SA1890-101		※	TC-310(BG)	51	S59221-101	BC-310(ANC)
BAS-341F-01	SA2173-101		※	TC-310(AF)	51	S59222-101	BC-310(AND)
BAS-342F-01	SA2173-101		※	TC-310(AF)	51	S59222-101	BC-310(AND)
BAS-346E,366E	SA1884-001		※	HSM-BRTR(HP370)	36	151845-001	BC-DBM(1)-NBL1
BAS-346E,366E	SA1885-001		※	HSM-B1HTR(HPNG)	-	151845-001	BC-DBM(1)-NBL1
BAS-346E,366E	SA1886-001		※	HSM-BRTR(HP370H)	-	151845-001	BC-DBM(1)-NBL1
BAS-346E,366E	SA1888-001		※	HSM-BRTR(HP370H7)	-	151845-001	BC-DBM(1)-NBL1
BAS-511	S19893-911			DP2-816	41	159157-001	BC-DP815
BAS-511	S19893-911			DP2-816	41	S01870-001	BC-DP815(P)
BAS-511	S19897-911			DP2-816(FR)	42	159157-001	BC-DP815
BAS-511	S19897-911			DP2-816(FR)	42	S01870-001	BC-DP815(P)
BAS-612,613	SA1692-002	○		HG12MC(1)	49	S09279-001	CP-G12MC(1)
BAS-6150	SA1694-002	○		HG12MC(1)TR	49	S09280-001	CP-G12MC(1)TR
BAS-6200	SA1694-002	○		HG12MC(1)TR	49	S09280-001	CP-G12MC(1)TR
BAS-7050	SA2173-101		※	TC-310(AF)	51	S59222-101	BC-310(AND)
BAS-7050	SA1890-101		※	TC-310(BG)	51	S59221-101	BC-310(ANC)
BAS-752~755	SA1628-001			HSH-7.94BTR(737QHP)	-	148350-101	BC-DB1-NBL6
BAS-761	SA1624-301		※	HTM-BTR(HP761)	37	S45664-101	BC-HTM(761)
BAS-7610	SA1625-201		※	HTH-BTR(HPNG)	34	S24904-201	BC-HTH(HPNG)
BAS-7610	SA1624-301		※	HTM-BTR(HP761)	37	S45664-101	BC-HTM(761)
BE-0101B-AC	SA1646-001			HSM-ATR(1Q)	35	S59992-001	BC-DBM(Z2)-NBL6
BES-1210AC	SA1646-001			HSM-ATR(1Q)	35	S59222-001	BC-DBM(Z2)-NBL6
BES-1260BC	SA3669-001			HSM-ATR(MQ1L)	36	S59222-001	BC-DBM(Z2)-NBL6
BES-1240AC	SA3669-001			HSM-ATR(MQ1L)	36	S59222-001	BC-DBM(Z2)-NBL6
BM-917B-00	115069-901			L-BQ1U	52		
CB3-B916A,917A	115069-901			L-BQ1U	52		
DB2-B736-1	SA1706-001			HSH-7.94B(RT)	32	100369-001	BC-DB1
DB2-B736-3	SA1706-001			HSH-7.94B(RT)	32	100369-001	BC-DB1
DB2-B736-5	SA1708-001			HSH-7.94BOH(1)	32	100369-001	BC-DB1
DB2-B737-1	SA1709-001			HSH-7.94BTR(737SPQ)	33	148350-101	BC-DB1-NBL6
DB2-B737-3	SA1931-001			HSH-7.94BTR(737)	33	148350-101	BC-DB1-NBL6
DB2-B737-5	SA1704-001			HSH-7.94BOHNTR(B)	32	148350-101	BC-DB1-NBL6
DB2-B746A	SA1723-001			HSM-B1H(1)	36	147790-001	BC-DBM
DB2-B748A	SA1722-001			HSM-B1HTR	36	151845-001	BC-DBM(1)-NBL1
DB2-B771	SA1715-001			HSH-7.94DRN(1)	34	100369-001	BC-DBM(1)
DB2-B772	SA1716-001			HSH-7.94DTR(1Q)	34	148350-101	BC-DB1-NBL6
DB2-B773	SA1706-001			HSH-7.94B(RT)	32	100369-001	BC-DB1
DB2-B774	SA1931-001			HSH-7.94BTR(737)	33	148350-101	BC-DB1-NBL6
DB2-B7740	SA1931-001			HSH-7.94BTR(737)	33	148350-101	BC-DB1-NBL6
DB2-B7741	SA1931-001			HSH-7.94BTR(737)	33	148350-101	BC-DB1-NBL6
DB2-B777A	SA1706-001			HSH-7.94B(RT)	32	100369-001	BC-DB1

BROTHER

MODEL 缝纫机机种	PART NO. 型号	WITH BC/CAP 配BC/CP	EX. ITEM 专卖品	HIROSE HOOK 广濑梭头		BOBBIN CASE 梭芯套	
				ITEM 品名	PAGE 页	PART NO. 型号	ITEM 品名
DB2-B778	SA1931-001			HSH-7.94BTR(737)	33	148350-101	BC-DB1-NBL6
DB2-B797	SA1720-001			HSM-A1	35	147790-001	BC-DBM(1)
DB2-B798	SA1722-001			HSM-B1HTR	36	151845-101	BC-DBM(1)-NBL1
DB3-B775	SA1718-001		※	HTH-BTR(NG23)	—	S24904-201	BC-HTH(HPNG)
DB3-B776	SA1718-001		※	HTH-BTR(NG23)	—	S24904-201	BC-HTH(HPNG)
DD7100	SA1931-001			HSH-7.94BTR(737)	33	148350-101	BC-DB1-NBL6
HE-8000-2	SA1744-001	○		DP2-800FR	41	S50237-001	BC-DP800
HE-8000-3	SA1744-001	○		DP2-800FR	41	S50237-001	BC-DP800
HE-8000-5	SA1744-001	○		DP2-800FR	41	S50237-001	BC-DP800
HM-8180	SA1747-001	○		DP2-818(FR)	42	S50237-001	BC-DP800
KE-484C-X	SA2036-101			HST-A(C)	36	S00691-401	BC-HST(B1)
LH4-B814	141307-901			DP2-LB	42	107097-101	BC-DP2(3B)
LH4-B816	S19893-911			DP2-816	41	159157-001	BC-DP815
LH4-B816	S19893-911			DP2-816	41	S01870-001	BC-DP815(P)
LH4-B816	S19897-911			DP2-816(FR)	42	159157-001	BC-DP815
LH4-B816	S19897-911			DP2-816(FR)	42	S01870-001	BC-DP815(P)
LH4-B817	S33032-901			DP2-817	42	107097-101	BC-DP2(3B)
LK3-B484(KE-484C)	S00688-901			HST-A	36	S00691-401	BC-HST(B1)
LK3-B484(KE-484C)	SA2036-101			HST-A(C)	36	S00691-401	BC-HST(B1)
LK3-B484(KE-484C)	S00689-901			HST-B	—	S00690-301	BC-HST(A1)
LS2-B891	SA1429-001			HAD-467TR(1B)	52		
LT2-B831	112691-901			HSH-12-15L	46		
LT2-B831-5	144903-901			HSH-12-15L(H)	46		
LT2-B835	150371-901			HSH-12-15LC	46	151041-001	CP-12C
LT2-B836	155466-901			HSH-12MC(1)	50	155476-001	CP-12MC(1)
LT2-B837	150966-901			HSH-12-15MM(5)	49		
LT2-B837-300	156379-911			HSH-12-15MM(5)TR1	49		
LT2-B838	153912-901			HSH-12-15MMB(5)	49		
LT2-B841	SA1670-011	○		HG12L(1)	45	S07740-001	CP-G12L(1)
LT2-B841-3	SA1668-011			HG12-15L	45		
LT2-B841-5	SA1669-011			HG12-15L(H)	45		
LT2-B842	SA1677-011			HG12-15L(TR1)	45		
LT2-B842	SA1678 011	○		HG12L(1)TR1	45	S07740-001	CP-G12L(1)
LT2-B842-3	SA1668-011			HG12-15L	45		
LT2-B842-5	SA1669-011			HG12-15L(H)	45		
LT2-B845	SA1681-011	○		HG12-15LC	45	S07741-001	CP-G12C
LT2-B845	SA1683-011	○		HG12-15LCTR1	45	S07742-001	CP-G12CTR1
LT2-B872	SA1685-002			HG12M(BR)	49		
LT2-B872	SA1689-002	○		HG12MC(1)TR	49	S09278-001	CP-G12M(BR)TR
LT2-B875	SA1692-002	○		HG12MC(1)	49	S09279-001	CP-G12MC(1)
LT2-B875	SA1694-002	○		HG12MC(1)TR	49	S09280-001	CP-G12MC(1)TR
LT2-B882	156514-901			HSH-12M(BR)	49		
LT2-B892	SA1429-001			HAD-467TR(1B)	52		
PR-600	XC6924-001			DA1-ATR(1QB)	38	XC7206-001	BC-HR5-NBL9
S-7200A-403	SA1391-002			HSH-7.94BTR(737)	33	148350-101	BC-DB1-NBL6
S-7200A-405	SA1704-001			HSH-7.94BOHNTR(B)	32	148350-101	BC-DB1-NBL6
S-7200A-433	SA1931-002			HSH-7.94BTR(737)	33	148350-101	BC-DB1-NBL6
S-7200A-43S	SA1709-001			HSH-7.94BTR(737SPQ)	33	148350-101	BC-DB1-NBL6
S-7200A-453	S52063-001		※	HSH-7.94BTR(1RPWL)	32	148350-101	BC-DB1-NBL6
S-7200A-45S	S52063-001		※	HSH-7.94BTR(1RPWL)	32	148350-101	BC-DB1-NBL6

BROTHER

MODEL 缝纫机机种	PART NO. 型号	WITH BC/CAP 配 BC/CP	EX. ITEM 专卖品	HIROSE HOOK 广濑梭头		BOBBIN CASE 梭芯套	
				ITEM 品名	PAGE 页	PART NO. 型号	ITEM 品名
SC-7760-705	SA1718-001		※	HTH-BTR(NG23)	—	S24904-201	BC-HTH(HPNG)
SL-1010-3	SA1706-001			HSH-7.94B(RT)	32	100369-001	BC-DB1
SL-1010-5	SA1708-001			HSH-7.94BOH(1)	32	100369-001	BC-DB1
SL-2010-3	SA1391-002			HSH-7.94BTR(737)	33	148350-101	BC-DB1-NBL6
SL-2010-5	SA1704-001			HSH-7.94BOHNTR(B)	32	148350-101	BC-DB1-NBL6
SL-737A-1	SA1709-001			HSH-7.94BTR(737SPQ)	33	148350-101	BC-DB1-NBL6
SL-737A-5	SA1391-002			HSH-7.94BTR(737)	33	148350-101	BC-DB1-NBL6
SL-737A-5	SA1704-001			HSH-7.94BOHNTR(B)	32	148350-101	BC-DB1-NBL6
SL-746A	SA1723-001			HSM-B1H(1)	36	147790-001	BC-DBM(1)
SL-777A-3	SA1706-001			HSH-7.94B(RT)	32	100369-001	BC-DB1
SL-778A-3	SA1391-002			HSH-7.94BTR(737)	33	148350-101	BC-DB1-NBL6
SN-7230-5	SA1722-001			HSM-B1HTR	36	151845-101	BC-DBM(1)-NBL1
SN-7240-5	SA1722-001			HSM-B1HTR	36	151845-001	BC-DBM(1)-NBL1
SN-771A-3	SA1715-001			HSH-7.94DRN(1)	34	100369-001	BC-DB1
SN-772A-3	SA1715-001			HSH-7.94DTR(1Q)	34	148350-101	BC-DB1-NBL6
T-8420A-003	SA1668-111			HR12-15L	45		
T-8420A-005	SA1669-111			HR12-15L(H)	45		
T-8420A-00F	SA1668-111			HR12-15L	45		
T-8420A-033	SA1668-111			HR12-15L	45		
T-8420A-03F	SA1668-111			HR12-15L	45		
T-8421A-T03	SA1668-111			HR12-15L	45		
T-8421A-T03	SA1670-111	○		HR12L(1)	45	S07740-001	CP-G12L(1)
T-8421A-T05	SA1669-111			HR12-15L(H)	45		
T-8421A-T33	SA1668-111			HR12-15L	45		
T-8421A-T3F	SA1668-111			HR12-15L	45		
T-8422A-403	SA1677-111			HR12-15L(TR1)	45		
T-8422A-403	SA1678-111	○		HR12L(1)TR1	45	S07740-001	CP-G12L(1)
T-8422A-405	SA1677-111			HR12-15L(TR1)	45		
T-8422A-433	SA1677-111			HR12-15L(TR1)	45		
T-8450A-003	SA1681-111	○		HR12-15LC	45	S07741-001	CP-G12C
T-8450A-005	SA1681-111	○		HR12-15LC	45	S07741-001	CP-G12C
T-8450A-033	SA1681-111	○		HR12-15LC	45	S07741-001	CP-G12C
T-8452A-403	SA1683-111	○		HR12-15LCTR1	45	S07742-001	CP-G12CTR1
T-8452A-405	SA1683-111	○		HR12-15LCTR1	45	S07742-001	CP-G12CTR1
T-8452A-433	SA1683-111	○		HR12-15LCTR1	45	S07742-001	CP-G12CTR1
T-8720A-003	SA1685-102			HR12M(BR)	49		
T-8720A-005	SA1685-102			HR12M(BR)	49		
T-8722A-403	SA1689-102	○		HR12MC(1)TR	49	S09278-001	CP-G12M(BR)TR
T-8722A-405	SA1689-102	○		HR12MC(1)TR	49	S09278-001	CP-G12M(BR)TR
T-8750A-003	SA1692-102	○		HR12MC(1)	49	S09279-001	CP-G12MC(1)
T-8750A-005	SA1692-102	○		HR12MC(1)	49	S09279-001	CP-G12MC(1)
T-8752A-403	SA1694-102	○		HR12MC(1)TR	49	S09280-001	CP-G12MC(1)TR
T-8752A-405	SA1694-102	○		HR12MC(1)TR	49	S09280-001	CP-G12MC(1)TR
TN-842A-003	SA1668-111			HR12-15L	45		
TN-842A-005	SA1669-111			HR12-15L(H)	45		
TN-842A-00F	SA1668-111			HR12-15L	45		
TN-842B-403	SA1670-011			HR12-15L(TR1)	45		
TN-842B-405	SA1670-011			HR12-15L(TR1)	45		
TN-842B-40F	SA1677-111			HR12-15L(TR1)	45		
TN-842B-40F	SA1678 111	○		HR12L(1)TR1	45	S07740-001	CP-G12L(1)

BROTHER

MODEL 缝纫机机种	PART NO. 型号	WITH BC/CAP 配 BC/CP	EX. ITEM 专卖品	HIROSE HOOK 广濑梭头		BOBBIN CASE 梭芯套	
				ITEM 品名	PAGE 页	PART NO. 型号	ITEM 品名
TN-845A-003	SA1681-111	○		HR12-15LC	45	S07741-001	CP-G12C
TN-845A-005	SA1681-111	○		HR12-15LC	45	S07741-001	CP-G12C
TN-845B-401	SA1683-111	○		HR12-15LCTR1	45	S07742-001	CP-G12CTR1
TN-845B-403	SA1683-111	○		HR12-15LCTR1	45	S07742-001	CP-G12CTR1
TN-845B-405	SA1683-111	○		HR12-15LCTR1	45	S07742-001	CP-G12CTR1
TN-872A-003	SA1685-102			HR12M(BR)	49		
TN-872A-005	SA1685-102			HR12M(BR)	49		
TN-872B-403	SA1689-102	○		HR12MC(1)TR	49	S09278-001	CP-G12M(BR)TR
TN-872B-405	SA1689-102	○		HR12MC(1)TR	49	S09278-001	CP-G12M(BR)TR
TN-875A-003	SA1692-102	○		HR12MC(1)	49	S09279-001	CP-G12MC(1)
TN-875A-005	SA1692-102	○		HR12MC(1)	49	S09279-001	CP-G12MC(1)
TZ1-B652	112041-901			DB1-Z16B	38	117596-001	BC-DBZ(1)
ZE-855A	SA1852-001			DP2-855	42	S48180-101	BC-DP855
ZE-856A	SA1853-001			DP2-856TR	42	S48202-101	BC-DP856
ZE-8570	SA1852-001			DP2-855	42	S48180-101	BC-DP855
ZE-8580	SA1853-001			DP2-856TR	42	S48202-101	BC-DP856

DURKOPP / ADLER (ADLER)

MODEL 缝纫机机种	PART NO. 型号	WITH BC/CAP 配 BC/CP	EX. ITEM 专卖品	HIROSE HOOK 广濑梭头		BOBBIN CASE 梭芯套	
				ITEM 品名	PAGE 页	PART NO. 型号	ITEM 品名
4	005-00-290-4			DD1(AD)	—		
5	005-00-290-4			DD1(AD)	—		
16	L-97(Hook) 6-11 (Base)			HWG-1	—		
20	20-195			HSH-7-3	51		
21	20-195			HSH-7-3	51		
45	L-97(Hook) 6-11 (Base)			HWG-1	—		
48	048-00125-2			TF1	51		
56	L-97(Hook) 6-11 (Base)			HWG-1	—		
58	L-97(Hook) 6-11 (Base)			HWG-1	—		
67	068-00-181-4	○		HAD-68	43	068-00-178-4	CP-HAD68
68	068-00-181-4	○		HAD-68	43	068-00-178-4	CP-HAD68
69-373	069-00-581-4	○		HPF-335(5)	39	069-00-578-4	BC-PF9076
91	098-15-007-4	○		DP2	41	098-00-178-4	BC-DP2(2)
96	096-15-281-4	○		DA1-B	38	097-00-178-4	BC-DB1
98	098-15-Q07-4	○		DP2	41	098-00-178-4	BC-DP2(2)
104	065-00-185-4			DD1-OP(2)	—		
105	065-00-185-4			DD1-OP(2)	—		
105	005-00-290-4			DD1(AD)	—		
166	065-00-185-4			DD1-OP(2)	—		
167	167-00-181-4	○		HAD-167	48	167-00-178-4	CP-HAD167
168	167-00-181-4	○		HAD-167	48	167-00-178-4	CP-HAD167
167-FA272	167-15-020-4	○		HAD-167TR	48	167-15-019-4	CP-HAD167TR
167-FA273	167-15-020-4	○		HAD-167TR	48	167-15-019-4	CP-HAD167TR
167-FA272NH	167-15-020-4	○		HAD-167TR	48	167-15-019-4	CP-HAD167TR
196	196-15-181-4	○		HAD-196B	—	097-00-178-4	BC-DB1
199	199-15-281-4	○		DB1-Z16	38	089-00-178-4	BC-DBZ(1)
204	204-15-010-4			HAD-204	51		
205	204-15-010-4			HAD-204	51		
220	220-181-4			HSH-445	50		
265	265-21-142			HSH-32	52		
267	167-00-181-4	○		HAD-167	48	167-00-178-4	CP-HAD167
267-FA	167-15-020-4	○		HAD-167TR	48	167-15-019-4	CP-HAD167TR
268	167-00-181-4	○		HAD-167	48	167-00-178-4	CP-HAD167
268-FA	268-15-017-4	○		HAD-267TR	48	268-150-444	CP-HAD267TR
289	199-15-281-4	○		DB1-Z16	38	089-00-178-4	BC-DBZ(1)
296	396-15-281-4	○		HAD-396	31	396-15-078-4	BC-AD396-NBL6
396	396-15-281-4	○		HAD-396	31	396-15-078-4	BC-AD396-NBL6
396	396-15-081-4	○		HAD-396H	31	396-15-078-4	BC-AD396-NBL6
467	467-15-009-4			HAD-467TR	52		
489	199-15-281-4	○		DB1-Z16	38	089-00-178-4	BC-DBZ(1)

DURKOPP / ADLER (DURKOPP)

MODEL 缝纫机机种	PART NO. 型号	WITH BC/CAP 配 BC/CP	EX. ITEM 专卖品	HIROSE HOOK 广濑梭头		BOBBIN CASE 梭芯套	
				ITEM 品名	PAGE 页	PART NO. 型号	ITEM 品名
21	L-97(Hook) 6-11 (Base)			HWG-1	—		
61	065-00-185-4			DD1-OP(2)	—		
62	065-00-185-4			DD1-OP(2)	—		
203	204325	○		DA2-B(TA1-B)	38	204335	BC-DB1
204	204325	○		DA2-B(TA1-B)	38	204335	BC-DB1
205	204325	○		DA2-B(TA1-B)	38	204335	BC-DB1
206	204695	○		DA1-B	38	204335	BC-DB1
207	204695	○		DA1-B	38	204335	BC-DB1
211	211261	○		HDU-211	31	211275	BC-DU211
211	211912	○		HDU-211(1)	31	211926	BC-DU211NS-2
212	211261	○		HDU-211	31	211275	BC-DU211
213	211261	○		HDU-211	31	211275	BC-DU211
215	211261	○		HDU-211	31	211275	BC-DU211
216	216161	○		HDU-216	—	204335	BC-DB1
218	211261	○		HDU-211	31	211275	BC-DU211
221	249592	○		HDU-249	43	249369	CP-HDU249
222	249592	○		HDU-249	43	249369	CP-HDU249
237	249592	○		HDU-249	43	249369	CP-HDU249
238	249592	○		HDU-249	43	249369	CP-HDU249
239	249592	○		HDU-249	43	249369	CP-HDU249
241	249592	○		HDU-249	43	249369	CP-HDU249
242	249592	○		HDU-249	43	249369	CP-HDU249
245	249592	○		HDU-249	43	249369	CP-HDU249
249	249592	○		HDU-249	43	249369	CP-HDU249
252	252781	○		DP2	41	235368	BC-DP2(2)
253	252781	○		DP2	41	235368	BC-DP2(2)
254	252781	○		DP2	41	235368	BC-DP2(2)
255	252781	○		DP2	41	235368	BC-DP2(2)
261	211912	○		HDU-211(1)	31	211926	BC-DU211NS-2
264	252781	○		DP2	41	235368	BC-DP2(2)
265	265951	○		HDU-265	39	265965	BC-DU265
265-108	265771	○		HDU-M265	35	265776	BC-DU265BIG
270	204695	○		DA1-B	38	204335	BC-DB1
271	271751	○		HDU-271	31	2111115	BC-DU211NS-4
271	0271150054	○	※	HDU-271(QRP)	31	271150054	BC-DB1-NBL6
272	2721121	○		HDU-272	31	2111115	BC-DU211NS-4
380	249592	○		HDU-249	43	249369	CP-HDU249
380	0381150204	○	※	HDU-381(RP)	—	0381150254	CP-HDU381
460	460243			HSH-8-20	42		
460	460312			HSH-8-20(S)	—		
541	249592	○		HDU-249	43	249369	CP-HDU249
542	249592	○		HDU-249	43	249369	CP-HDU249
543	249592	○		HDU-249	43	249369	CP-HDU249
549	249592	○		HDU-249	43	249369	CP-HDU249
551	555901	○		HDU-551	—		BC-HDU551
555	555901	○		HDU-551	—		BC-HDU551
556	5565001	○		HDU-556	42	5565044	BC-HDU556

HAPPY

MODEL 缝纫机机种	PART NO. 型号	WITH BC/CAP 配 BC/CP	EX. ITEM 专卖品	HIROSE HOOK 广濑梭头		BOBBIN CASE 梭芯套	
				ITEM 品名	PAGE 页	PART NO. 型号	ITEM 品名
HCM	ESMPZ00050			HSH-7.94A(M3Q)	39		BC-DBZ(3)NBL6
HCM	ESMPZ01260			HSH-7.94A(M3QTS)	—		BC-DBZ(3)NBL6
HCM	ESHPA04010			HSH-7.94ATR(M3Q)	39		BC-DBZ(3)NBL6
HMF	ESMPZ00050			HSH-7.94A(M3Q)	39		BC-DBZ(3)NBL6
HMF	ESMPZ01260			HSH-7.94A(M3QTS)	—		BC-DBZ(3)NBL6
HMF	ESHPA04010			HSH-7.94ATR(M3Q)	39		BC-DBZ(3)NBL6
HCG	ESHPA04010			HSH-7.94ATR(M3Q)	39		BC-DBZ(3)NBL6
HCS	ESHPA04010			HSH-7.94ATR(M3Q)	39		BC-DBZ(3)NBL6

JANOME

MODEL	PART NO.	WITH BC/CAP	EX. ITEM	HIROSE HOOK		BOBBIN CASE	
				ITEM	PAGE	PART NO.	ITEM
DB-J701	701-505-004			HSH-7.94B	31	761-511-009	BC-DB1
DB-J702	701-505-004			HSH-7.94B	31	761-511-009	BC-DB1
DB-J703	701-505-004			HSH-7.94B	31	761-511-009	BC-DB1
DB-J704	701-505-004			HSH-7.94B	31	761-511-009	BC-DB1
DB-J705	703-504-009			HSH-7.94A	31	761-511-009	BC-DB1
DB-J706	703-504-009			HSH-7.94A	31	761-511-009	BC-DB1
DB-J707	701-505-004			HSH-7.94B	31	761-511-009	BC-DB1
DB-J708	701-505-004			HSH-7.94B	31	761-511-009	BC-DB1
TA-J761	761-510-008			DA1-B	38	761-511-009	BC-DB1
TA-J763	761-510-008			DA1-B	38	761-511-009	BC-DB1
TA-J766	761-510-008			DA1-B	38	761-511-009	BC-DB1

JUKI

MODEL 缝纫机机种	PART NO. 型号	WITH BC/CAP 配 BC/CP	EX. ITEM 专用品	HIROSE HOOK 广濑梭头		BOBBIN CASE 梭芯套	
				ITEM 品名	PAGE 页	PART NO. 型号	ITEM 品名
APW-116	G18301160B0	○		HSH-21-40A(2)	—	G18311160A0	CP-21(2)
APW-192N~196N	16421760	○		HSH-12(570)	45	16422065	CP-12(570TC)
APW-231N~239N	16421760	○		HSH-12(570)	45	16422065	CP-12(570TC)
APW-297,298	25443953	○		HSH-12(570YA)	—	16422065	CP-12(570TC)
AVP-870	G181487000A		※	HSH-7.94BTR(2QSPHPNG7)	—	G18168700A0	UNAVAILABLE
AVP-870	G1814870A0A		※	HSH-7.94BTR(2QSPHPNG7A)	—	G18168700A0	UNAVAILABLE
AVP-875A	G1814875AA0		※	HTH-BTR(2SPHPNG20E)	34	G18168750A0	BC-HTH(2E)
AVP-875A	G18148750AA		※	HTH-BTR(2SPHPNG18E)	—	G18168750A0	BC-HTH(2E)
AVP-875A	G18148750AB		※	HTH-BTR(2SPHPNG16E)	—	G18168750A0	BC-HTH(2E)
AVP-880	G18148800AB		※	HSH-7.94BTR(2QSPHPNG8)	—	G18168700A0	UNAVAILABLE
DDL-105	B18300120A0			HSH-7.24BJ	31	B18370120A0	BC-DB1
DDL-115	B18300090A0			DA1-B	38	B18370120A0	BC-DB1
DDL-127	B18301270A0			HSH-7.94B	31	B18370120A0	BC-DB1
DDL-201	B18302010A0			HSM-B1	36	B18372010A0	BC-DBM(1)
DDL-201H	B1830201HA0			HSM-B1H	36	B18372010A0	BC-DBM(1)
DDL-201S	B1830201SA0			HSM-A1SH	35	B18372010A0	BC-DBM(1)
DDL-5530	11038650			HSH-7.94BTR	32	11038759	BC-DB1-NBL7
DDL-5530H	11092459			HSH-7.94B(SPH)	32	11038759	BC-DB1-NBL7
DDL-5530N	B18301270A0			HSH-7.94B	31	B18370120A0	BC-DB1
DDL-5550	B18301270A0			HSH-7.94B	31	B18370120A0	BC-DB1
DDL-5550H-6	11092251			HSH-7.94BTR(SPH)	33	11038759	BC-DB1-NBL7
DDL-5550N	B18301270A0			HSH-7.94B	31	B18370120A0	BC-DB1
DDL-5550U	D1830555BAG			HSH-7.94CTR	34	B1837555BAA	BC-DB1-NBL6
DDL-5570	11038650			HSH-7.94BTR	32	B1837555BAA	BC-DB1-NBL6
DDL-5570M	D1830555BA0			HSH-7.94BTR	32	B1837555BAA	BC-DB1-NBL6
DDL-5571N	11038650			HSH-7.94BTR	32	B1837555BAA	BC-DB1-NBL6
DDL-5571NE	11079456			HSH-7.94BTR(RP)	—	B1837555BAA	BC-DB1-NBL6
DDL-5571NM	11038650			HSH-7.94BTR	32	B1837555BAA	BC-DB1-NBL6
DDL-5580	11038650			HSH-7.94BTR	32	B1837555BAA	BC-DB1-NBL6
DDL-5580H	D1830415BAH			HSH-7.94BOHNTR	32	B1837415DAL	BC-DLN-NBL
DDL-5581N	11038650			HSH-7.94BTR	32	B1837555BAA	BC-DB1-NBL6
DDL-5600NJ	B18302010A0			HSM-B1	36	B1837201SA0	BC-DBM(1)-NBL1
DDL-5600NJ-7-0B	D1830560EAO			HSM-B1HTR(2)	36	B1837201SA0	BC-DBM(1)-NBL1
DDL-5600NL	B18302010A0			HSM-B1	36	B1837201SA0	BC-DBM(1)-NBL1
DDL-5600NL-7-0B	D1830560EAO			HSM-B1HTR(2)	36	B1837201SA0	BC-DBM(1)-NBL1
DDL-8700-7	11038650			HSH-7.94BTR	32	B1837555BAA	BC-DB1-NBL6
DDL-9000DF,DS	22890404		※	HSH-7.94BTR(2QSPRPW)	—	11038759	BC-DB1-NBL7
DDL-9000DF,DS	22890206		※	HSH-7.94BTR(2SPRPW)	—	11038759	BC-DB1-NBL7
DDL-9000DF,DS	22890305		※	HSH-7.94BTR(2SPRPWS)	33	11038759	BC-DB1-NBL7
DDL-9000SH	11092251			HSH-7.94BTR(SPH)	33	11038759	BC-DB1-NBL7
DDL-9000SS	11038650			HSH-7.94BTR	32	B1837555BAA	BC-DB1-NBL6
DDL-9000SS	11141355			HSH-7.94BTR(QSP)	33	B1837555BAA	BC-DB1-NBL6
DDL-9000SS	23621303			HSH-7.94BTR(QSPHP)	—	B1837555BAA	BC-DB1-NBL6
DLD-5430	B18301270A0			HSH-7.94B	31	B18370120A0	BC-DB1
DLD-5430N	B18301270A0			HSH-7.94B	31	B18370120A0	BC-DB1
DLD-5430N-7	11038650			HSH-7.94BTR	32	B1837555BAA	BC-DB1-NBL6
DLD-5430N-7	11141355			HSH-7.94BTR(QSP)	33	B1837555BAA	BC-DB1-NBL6
DLM-5200	B18301270A0			HSH-7.94B	31	B18370120A0	BC-DB1

JUKI

MODEL 缝纫机机种	PART NO. 型号	WITH BC/CAP 配 BC/CP	EX. ITEM 专卖品	HIROSE HOOK 广濑梭头		BOBBIN CASE 梭芯套	
				ITEM 品名	PAGE 页	PART NO. 型号	ITEM 品名
DLM-5200N	B18301270A0			HSH-7.94B	31	B18370120A0	BC-DB1
DLM-5210N	B18301270A0			HSH-7.94B	31	B18370120A0	BC-DB1
DLM-5400N-7	11038650			HSH-7.94BTR	32	B1837555BAA	BC-DB1-NBL6
DLM-5400N-7	11141355			HSH-7.94BTR(QSP)	33	B1837555BAA	BC-DB1-NBL6
DLM-5420N-7	11038650			HSH-7.94BTR	32	B1837555BAA	BC-DB1-NBL6
DLM-5420N-7	11141355			HSH-7.94BTR(QSP)	33	B1837555BAA	BC-DB1-NBL6
DLN-412	B18304120A0			HSH-7.94DN	—	B18370410A0	BC-DLN
DLN-415	B18304150A0			HSH-7.94BSN	32	B18370410A0	BC-DLN
DLN-415H	B1830415BAH			HSH-7.94BOHNTR	32	B1837415DAL	BC-DLN-NBL
DLN-415L	B1830415LA0			HSH-7.94BOHN(1)	32	B1837415DAL	BC-DLN-NBL
DLN-5410N	B18304150A0			HSH-7.94BSN	32	B18370410A0	BC-DLN
DLN-5410N-7	11038650			HSH-7.94BTR	32	11038759	BC-DB1-NBL7
DLN-5410NH-7	11321452			HSH-7.94BKTR(2)	32	11038759	BC-DB1-NBL7
DLN-5410NJ-7	D1830560EAO			HSM-B1HTR(2)	36	B1837241H00	BC-DBM(2)-NBL1
DLN-6390-7	40003894		※	HTH-614BTR(2E)	34	40003895	BC-HTH(2EA)
DLN-9010SH	11092251			HSH-7.94BTR(SPH)	33	B1837555BAA	BC-DB1-NBL6
DLN-9010SS	11038650			HSH-7.94BTR	32	B1837555BAA	BC-DB1-NBL6
DLN-9010SS	11141355			HSH-7.94BTR(QSP)	33	B1837555BAA	BC-DB1-NBL6
DLU-5490N	B18301270A0			HSH-7.94B	31	B18370120A0	BC-DB1
DLU-5490N-7	11038650			HSH-7.94BTR	32	B1837555BAA	BC-DB1-NBL6
DLU-5494N-7	11038650			HSH-7.94BTR	32	B1837555BAA	BC-DB1-NBL6
DMN-5420N-7	11038650			HSH-7.94BTR	32	B1837555BAA	BC-DB1-NBL6
DMN-5420N-7	11141355			HSH-7.94BTR(QSP)	33	B1837555BAA	BC-DB1-NBL6
DNU-1541	B1830241HA0			HSM-A1TR(280)	35	B1837241H00	BC-DBM(2)-NBL1
DNU-1541	B1830241HA0			HSM-A1TR(280)	35	B1837241H00	BC-DBM(2)-NBL1
DNU-241H	B1830241HA0			HSM-A1TR(280)	35	B1837241H00	BC-DBM(2)-NBL1
DNU-241HS	B1830241SA0			HSM-A(6)	35	B1837241H00	BC-DBM(2)-NBL1
DNU-261H	B1830241HA0			HSM-A1TR(280)	35	B1837241H00	BC-DBM(2)-NBL1
DSC-246,246V	B1830241HA0			HSM-A1TR(280)	35	B1837241H00	BC-DBM(2)-NBL1
DSU-144N	B1830201SA0			HSM-A1SH	35	B18372010A0	BC-DBM(1)
DSU-145	D1830560EAO			HSM-B1HTR(2)	36	B1837241H00	BC-DBM(2)-NBL1
DSU-145-7	D1830560EAO			HSM-B1HTR(2)	36	B1837241H00	BC-DBM(2)-NBL1
DU-141NH	B1830141HA0			HSM-A1	35	B18372010A0	BC-DBM(1)
DU-580	B1830141HA0			HSM-A1	35	B18372010A0	BC-DBM(1)
LBH-1700	13729066			DP2-NJ(790)	42	13729769	BC-LBH790
LBH-1790S	13729066			DP2-NJ(790)	42	13729769	BC-LBH790
LBH-1792K	13782065			DP2-NJ(791K)	42	13729769	BC-LBH790
LBH-761~763	B18017610A0			DP2-NJ	42	B18107610A0	BC-107(2)
LBH-771~773	B18087710AC			DP2-NJ771	42	B18107710A0	BC-LBH771
LBH-781~784	B18087710AC			DP2-NJ771	42	B18107710A0	BC-LBH771
LBH-791~794	13729066			DP2-NJ(790)	42	13729769	BC-LBH790
LBH-791S~794S	13729066			DP2-NJ(790)	42	13729769	BC-LBH790
LG-158	B1830057SA0			HSH-445(6SP)	50		
LG-158-1	B1830057SA0			HSH-445(6SP)	50		
LG-57	B1830057SA0			HSH-445(6SP)	50		
LH-1152	10110153	○		HSH-12(2)	45	10110252	CP-12(2)
LH-1152	10197655			HSH-12-15(2)	46		
LH-1152-4	10110054	○		HSH-12(2)TR	45	10110252	CP-12(2)

JUKI

MODEL 缝纫机机种	PART NO. 型号	WITH BC/CAP 配 BC/CP	EX. ITEM 专用品	HIROSE HOOK 广濑梭头		BOBBIN CASE 梭芯套	
				ITEM 品名	PAGE 页	PART NO. 型号	ITEM 品名
LH-1152-4	10195154			HSH-12-15(2)TR	46		
LH-1162	10207959	○		HSH-12-62C(L)	46	10208254	CP-62C
LH-1162	10208056	○		HSH-12-62C(R)	46	10208254	CP-62C
LH-1162-4	10207751	○		HSH-12-62CTR(L)	46	10208254	CP-62C
LH-1162-4	10207850	○		HSH-12-62CTR(R)	46	10208254	CP-62C
LH-1182	10232957	○		HSH-12M-82C(L)	50	10231553	CP-M82C
LH-1182	10233054	○		HSH-12M-82C(R)	50	10231553	CP-M82C
LH-1182-4	10231058	○		HSH-12M-82CTR(L)	50	10231553	CP-M82C
LH-1182-4	10331157	○		HSH-12M-82CTR(R)	50	10231553	CP-M82C
LH-3120A	22612055			H12-15L	45		
LH-3120F	22612055			H12-15L	45		
LH-3126F	23209455		※	H12-15L(TR2AE)	45		
LH-3128	22612055			H12-15L	45		
LH-3128	22612758	○		H12L(1)	45	22612659	CP-G12L(2)
LH-3128-7	22653158			H12-15L(TR2)	45		
LH-3128-7	22653059	○		H12-15LCTR2	45	22612659	CP-G12L(2)
LH-3162-7	22693857	○		H12-15LCTR2	45	22688154	CP-G12C(2)
LH-3168	22688253	○		H12-15LC	45	22688154	CP-G12C(2)
LH-3168-7	22693857	○		H12-15LCTR2	45	22688154	CP-G12C(2)
LH-3178	22813455			H12MM(2)	49		
LH-3178	22814255	○		H12MC(2)	49	22819650	CP-G12M(2)TR
LH-3178-7	22831259	○		H12MC(2)TR	49	22827257	CP-G12MC(2)
LH-3178-7	22820666			H12MM(2)TR	49		
LH-3188	22827158	○		H12MC(2)	49	22827257	CP-G12MC(2)
LH-3188-7	22831259	○		H12MC(2)TR	49	22827257	CP-G12MC(2)
LH-512, 515	B18305120A0			HSH-21-40(J)	47		
LH-512H, 515H	B18305120AH			HSH-21-40(AJ)	47		
LH-525N	G18301190A0	○		HSH-11-55M(2)	45	G18311160A0	CP-21(2)
LH-527	B18305210A0	○		HSH-12MC(2)	50	B18375260A0	CP-12MC
LH-528	B18305280A0	○		HSH-21-40(2)	47	B18375280A0	CP-12C
LH-529	G18301190A0	○		HSH-11-55M(2)	45	G18311160A0	CP-21(2)
LH-570, 571	18421760	○		HSH-12(570)	45	18422065	CP-12(570TC)
LK-1941,1942	14436158		※	HST-A(HPD)	—	14436257	BC-HST(2)
LK-1941,1942	14436307		※	HST-A(HPQC)	36	14436257	BC-HST(2)
LK-1941,1942	14436554		※	HST-B1(HPA)	36	14436257	BC-HST(2)
LK-1941,1942	14436703		※	HST-B1(HPQB)	—	14436257	BC-HST(2)
LS-1341	21431358	○		HYM-1341BY	48	21431606	CP-HPF545
LS-1342	21431457			HYM-1341BY(6)	48		
LS-1342	21435458			HYM-1341AY(6)	48		
LS-1342-7	21441753			HYM-1341BTR(6)	48		
LS-1342-7	21435854			HYM-1341ATR(6)	48		
LS-341N-7	23102353	○		HYM-341TR	—	21431606	CP-HPF545
LT-591	B18300590A0			HSH-445-59	50		
LU-1508NH	B1830563BA0			HSH-12-15MMJ(A)	49		
LU-1508NS	B18305630A0			HSH-12-15MMJ	49		
LU-1510N	B18305630A0			HSH-12-15MMJ	49		
LU-1510N-7	21387055		※	HSH-12MMA(6)TR	50		
LU-1520N-7	21393756		※	HSH-12MMJ(6)TR	—		
LU-1560N	B18305630A0			HSH-12-15MMJ	49		
LU-1560N-7	21387055		※	HSH-12MMA(6)TR	50		

JUKI

MODEL 缝纫机机种	PART NO. 型号	WITH BC/CAP 配BC/CP	EX. ITEM 专卖品	HIROSE HOOK 广濑梭头		BOBBIN CASE 梭芯套	
				ITEM 品名	PAGE 页	PART NO. 型号	ITEM 品名
LU-1565N	B18305210A0	○		HSH-12MCA(2)	—	B18375260A0	CP-12MC
LU-2210N-7	10761252		※	HAD-467TR(6A)	52		
LU-2210W-7	10756757		※	HAD-M467TR(6)	52		
LU-2216N-7	10761252		※	HAD-467TR(6A)	52		
LU-2260N-7	10761252		※	HAD-467TR(6A)	52		
LU-2260W-7	10756757		※	HAD-M467TR(6)	52		
LU-2266N-7	10761252		※	HAD-467TR(6A)	52		
LU-563	B18305630A0			HSH-12-15MMJ	49		
LU-563-3	B1830563BA0			HSH-12-15MMJ(A)	49		
LUH-521	B1830521HA0	○		HSH-12MCA(2)	50	B18375260A0	CP-12MC
LUH-526	B18305210A0	○		HSH-12MC(2)	50	B18375260A0	CP-12MC
LZ-1280	10032555			DP2-57(3LP)	41	11034056	BC-DP57
LZ-2280N、2281N	22525059			DP2-57(3LP2R)	41	22524169	UNAVAILABLE
LZ-2282N-7、2284N-7	22525877		※	DP2-57(3LP2V)	41	22525141	UNAVAILABLE
LZ-2282N-7、2284N-7	22526677		※	DP2-57(3LP2VRP)	—	22525141	UNAVAILABLE
LZ-2282N-7、2284N-7	22526578		※	DP2-57(3LP2VRP)	—	22525141	UNAVAILABLE
LZ-2283N、2284N	22525059			DP2-57(3LP2R)	41	22524169	UNAVAILABLE
LZ-2290A-DS	23557259		※	DP2-57(3LP2VRPW)	41	23537459	UNAVAILABLE
LZ-2290A-DS-7	23557259		※	DP2-57(3LP2VRPW)	41	23537459	UNAVAILABLE
LZ-2290A-DS-7-CB	23557259		※	DP2-57(3LP2VRPW)	41	23537459	UNAVAILABLE
LZ-2290A-DU	23557259		※	DP2-57(3LP2VRPW)	41	23537459	UNAVAILABLE
LZ-2290A-DU-7	23557259		※	DP2-57(3LP2VRPW)	41	23537459	UNAVAILABLE
LZ-2290A-DU-7-CB	23557259		※	DP2-57(3LP2VRPW)	41	23537459	UNAVAILABLE
LZ-2290A-SR-7-CB	22525877		※	DP2-57(3LP2V)	41	23537459	UNAVAILABLE
LZ-2290A-SR-7-WB	22525877		※	DP2-57(3LP2V)	41	23537459	UNAVAILABLE
LZ-2290A-SS	22525877		※	DP2-57(3LP2V)	41	23537459	UNAVAILABLE
LZ-2290A-SS-7	22525877		※	DP2-57(3LP2V)	41	23537459	UNAVAILABLE
LZ-2290A-SS-7-CB	22525877		※	DP2-57(3LP2V)	41	23537459	UNAVAILABLE
LZ-2290A-SU	22525877		※	DP2-57(3LP2V)	41	23537459	UNAVAILABLE
LZ-2290A-SU-7	22525877		※	DP2-57(3LP2V)	41	23537459	UNAVAILABLE
LZ-2290A-SU-7-CB	22525877		※	DP2-57(3LP2V)	41	23537459	UNAVAILABLE
LZ-271	B18300270A0			DB1-Z16	38	B18370270A0	BC-DBZ(1)
LZ-271	B18300270A0			DB1-Z16	38	B18370270A0	BC-DBZ(1)
LZ-391	B18307100A0			DB1-Z710	39	B18370270A0	BC-DBZ(1)
LZ-391N	B18307100A0			DB1-Z710	39	B18370270A0	BC-DBZ(1)
LZ-586	B1830581BA0			HSH-7.24BJZ	31	B18375860A0	BC-DBZ(2)
MB-372~373	B1239372000			L-BQ1U	52		
PLC-1610	23039159	○		HAD-161(6)	48	23039258	CP-HAD161(6)
PLC-1610-7	23025059	○		HAD-160TR(6)	48	23025257	CP-HAD267TR
PLC-1610J-7	23026057			HAD-166BTR	48		
PLC-1660	23039159	○		HAD-161(6)	48	23039258	CP-HAD161(6)
PLC-1660-7	23025059	○		HAD-160TR(6)	48	23025257	CP-HAD267TR
PLC-1660-7	23027568			HAD-166TR	48		
PLC-1660L	23028053	○		HAD-160(6)	48	23028061	CP-HAD167(6)
PLC-1665	23029051	○		HAD-160(6)	48	23029069	CP-HAD167CTR
PLC-1690A、S	23039159	○		HAD-161(6)	48	23039258	CP-HAD161(6)
PLC-1691	23044159	○		HAD-88(6)	—	23044357	CP-HAD68(6)
PLC-1760	23058555			HAD-160(1341A)	48		
PLH-981	21010251			HSH-31(6)	43		
PLH-982	21010251			HSH-31(6)	43		

JUKI

MODEL 缝纫机机种	PART NO. 型号	WITH BC/CAP 配BC/CP	EX. ITEM 专卖品	HIROSE HOOK 广濑梭头		BOBBIN CASE 梭芯套	
				ITEM 品名	PAGE 页	PART NO. 型号	ITEM 品名
PLN-985	21010251			HSH-31(6)	43		
PLN-986	21010251			HSH-31(6)	43		
TSC-441	21041850			HAD-204(273)	51		
TSC-461	21041850			HAD-204(273)	51		
TSH-411	21041850			HAD-204(273)	51		
TSN-421	21041850			HAD-204(273)	51		
TSU-471	21041850			HAD-204(273)	51		
TU-243	21041850			HAD-204(273)	51		
TU-273	21041850			HAD-204(273)	51		

MAMMUT

MODEL	PART NO.	WITH BC/CAP	EX. ITEM	HIROSE HOOK		BOBBIN CASE	
				ITEM	PAGE	PART NO.	ITEM
			※	HMU-1	52		
			※	HMU-2	-		

MARCO

MODEL	PART NO.	WITH BC/CAP	EX. ITEM	HIROSE HOOK		BOBBIN CASE	
				ITEM	PAGE	PART NO.	ITEM
				HMA-1	-		

MITSUBISHI

MODEL 缝纫机机种	PART NO. 型号	WITH BC/CAP 配 BC/CP	EX. ITEM 专卖品	HIROSE HOOK 广濑梭头		BOBBIN CASE 梭芯套		
				ITEM 品名	PAGE 页	PART NO. 型号	ITEM 品名	
DY-253	P975003X01 MG23E0121			HSH-32	52			
DY-350-12	A190D302P01 MF22B0120			HSH-7.94A(3)	31	P976009X01 MF10E0125	BC-DB1	
DY-350-22	A190D305P01 MF25B0120			HSM-AM(3)	35	P976015X01 MF25E0125	BC-DBM(1)	
DY-359-22	A190D522P01 MG44B0120			HSM-A1HMTR	35	A190D175P01 MG44E0125	BC-DBM(4)NBL3	
LG2-3370-M	A190D359P02 MF40A0120			HSH-7.94BTR	32	P976006X02 MF40E0125	BC-DB1-NBL6	
LG2-3370-M1T	A190D359P02 MF40A0120			HSH-7.94BTR	32	P976006X02 MF40E0125	BC-DB1-NBL6	
LS2-130-BOB	A190D305P01 MF25B0120			HSM-AM(3)	35	P976015X01 MF25E0125	BC-DBM(1)	
LS2-1130-B	A190D305P01 MF25B0120			HSM-AM(3)	35	P976015X01 MF25E0125	BC-DBM(1)	
LS2-1130-BOB	A190D305P01 MF25B0120			HSM-AM(3)	35	P976015X01 MF25E0125	BC-DBM(1)	
LS2-130-HOB	A190D302P01 MF22A0120			HSH-7.94A(3)	31	P976009X01 MF10E0125	BC-DB1	
LS2-1130-HOB	A190D302P01 MF22A0120			HSH-7.94A(3)	31	P976009X01 MF10E0125	BC-DB1	
LS2-1130-MOB	P975007X01 MF16A0120			HSH-7.94B	31	P976009X01 MF10E0125	BC-DB1	
LS2-150-MOB	P975007X01 MF16A0120			HSH-7.94B	31	P976009X01 MF10E0125	BC-DB1	
LS2-1180-H	P975025X02 MF42B0120			HSH-7.94BOHNTR	32	P976006X02 MF40E0125	BC-DB1-NBL6	
LS2-1180-L1T	A190D359P02 MF40A0120			HSH-7.94BTR	32	P976006X02 MF40E0125	BC-DB1-NBL6	
LS2-1180-M1T	A190D359P02 MF40A0120			HSH-7.94BTR	32	P976006X02 MF40E0125	BC-DB1-NBL6	
LS2-1180-M1TW	A190D359P02 MF40A0120			HSH-7.94BTR	32	P976006X02 MF40E0125	BC-DB1-NBL6	
LS2-1280-M1T	A190D359P02 MF40A0120			HSH-7.94BTR	32	P976006X02 MF40E0125	BC-DB1-NBL6	
LS2-2210-M1T	A190D223P01 MN35A0120			HSH-7.94BTR(210)	—	A190D222P01 MN35A0125	BC-DLN-NBL	
LS2-2210-M1TW	A190D223P01 MN35A0120			HSH-7.94BTR(210)	—	A190D222P01 MN35A0125	BC-DLN-NBL	
LT2-2220-BOB	A190D111P01 MN12B0120			HSH-12-15MM	49			
LT2-2220-MOB	A190D110P01 MN10A0120			HSH-12-15M	46			
LT2-2230-B1T	A190D298P01 MN74E0120			HSH-12-15MM(3)TR	49			
LT2-2230-M	A190D434P01 MN72E0120			HSH-12-15MTR(3)	46			
LT2-2230-M1TW	A190D434P01 MN72E0120			HSH-12-15MTR(3)	46			
LT2-2240-BOB	P975042X02 MN57A0120	○		HSH-12MC	50	MN26A0125	CP-12MC	
LT2-2240-MOB	P975041X01 MN25A0120	○		HSH-12C	46	MN27A0125	CP-12C	
LT2-2250-B1T	A190D091P01 MN62E0120	○		HSH-12MC(3)	50	MN62A0125	CP-12MC(3)	
LT2-2250-M1TW	A190D071P01 MN60E0120	○		HSH-12-15M(3)	46	MN60A0125	CP-12C	
LX2-630-M1	A190D071P01 MN60E0120	○		HSH-12-15M(3)	46	MN50E0125	CP-12(3)	
LX2-371-MO	P975012X01 MF60A0120			DA1-B	38	P976009X01 MF10E0125	BC-DB1	
LX5-871-MO	P975019X01 MQ70A0120			HPF-190	—		CP-HPF190	
LU2-400-BOB	P975034X01 MP02B0120			HSH-12-15MM(V)	49			
LU2-410-B1T	A190D571P01 MP43A0120			HSH-12-15MM(410M2)	49			
LU2-420-BOB	P975034X02 MP02B0120			HSH-12-15MM(V)	49			
LU2-430-B1T	A190D090P01 MN52E0120	○		HSH-12M(3)	49	MN52E0125	CP-12M(230)	
LU2-4410-B1T	A190D090P01 MN52E0120	○		HSH-12M(3)	49	MN52E0125	CP-12M(230)	
LT2-4410-B1T	A190D097P01			HSH-12MA(3)	50	MN52E0125	CP-12M(230)	
LU2-4430-B1T	A190D571P01 MP43A0120			HSH-12-15MM(410M2)	49			
LU2-4400	P975034X01 MP02B0120			HSH-12-15MM(V)	49			
LU2-4420	P975034X01 MP02B0120			HSH-12-15MM(V)	49			
LU2-4412-B1T	A190D571P01 MP43A0120			HSH-12-15MM(410M2)	49			
LU2-4650-B1T	A190D571P01 MP43A0120			HSH-12-15MM(410M2)	49			
LU2-4652-B1T	A190D571P01 MP43A0120			HSH-12-15MM(410M2)	49			
LU2-4710-B1T	A190D571P01 MP43A0120			HSH-12-15MM(410M2)	49			
LU2-4730-B1T	A190D571P01 MP43A0120			HSH-12-15MM(410M2)	49			

MITSUBISHI

MODEL 缝纫机机种	PART NO. 型号	WITH BC/CAP 配 BC/CP	EX. ITEM 专卖品	HIROSE HOOK 广濑梭头		BOBBIN CASE 梭芯套	
				ITEM 品名	PAGE 页	PART NO. 型号	ITEM 品名
LY2-3300-BOB	A190D522P01 MG44B0120			HSM-A1HMTR	35	A190D175P01 MG44E0125	BC-DBM(4)NBL3
LY3-6850-B1T	A133C226G01			HSM-A1HTR(T)	35	A190D175P01 MG44E0125	BC-DBM(4)NBL3
LY3-6840-BOT	A190D522P01 MG44B0120			HSM-A1HMTR	35	A190D175P01 MG44E0125	BC-DBM(4)NBL3
CU-865-12	P975001X01 MF65B0120			DA1-A	38	P976009X01 MF10E0125	BC-DB1
CU-865-22FP	P975033X01 MF25B0120			HSM-AM(3)	35	P976015X01 MF25E0125	BC-DBM(1)
PLY-501F	E000056H01 MN26B0120	○		HSH-12MC	50	MN26A0125	CP-12MC
PLY-1185	A190D090P01 MN52E0120	○		HSH-12MC(3)	50	MN52E0125	CP-12M(230)
PLY-7181	A190D090P01 MN52E0120	○		HSH-12MC(3)	50	MN52E0125	CP-12M(230)
PLY-7182	A190D090P01 MN52E0120	○		HSH-12MC(3)	50	MN52E0125	CP-12M(230)
PLY-7202	A190D090P01 MN52E0120	○		HSH-12MC(3)	50	MN52E0125	CP-12M(230)
PLY-7206	A190D090P01 MN52E0120	○		HSH-12MC(3)	50	MN52E0125	CP-12M(230)
PLY-7206E	A190D090P01 MN52E0120	○		HSH-12MC(3)	50	MN52E0125	CP-12M(230)
PLK-1210	A190D522P01 MG44B0120			HSM-A1HMTR	35	A190D175P01 MG44E0125	BC-DBM(4)NBL3
PLK-1410	A190D522P01 MG44B0120			HSM-A1HMTR	35	A190D175P01 MG44E0125	BC-DBM(4)NBL3
PLK-E2010R	A190D522P01 MG44B0120			HSM-A1HMTR	35	A190D175P01 MG44E0125	BC-DBM(4)NBL3
PLK-E2516R	A190D522P01 MG44B0120			HSM-A1HMTR	35	A190D175P01 MG44E0125	BC-DBM(4)NBL3
PLK-E1008H	A121B831H01			HAD-204(273M)	—		
PLK-E3040	A190D641P01			HSH-33(3)SF	—		
PLK-E7191	A190D090P01 MN52E0120	○		HSH-12MC(3)	50	MN52E0125	CP-12M(230)
PLK-E7194	A190D090P01 MN52E0120	○		HSH-12MC(3)	50	MN52E0125	CP-12M(230)
PLK-E7203	A190D090P01 MN52E0121	○		HSH-12MC(3)	50	MN52E0125	CP-12M(230)

NECCHI

MODEL 缝纫机机种	PART NO. 型号	WITH BC/CAP 配 BC/CP	EX. ITEM 专用品	HIROSE HOOK 广濑梭头		BOBBIN CASE 梭芯套	
				ITEM 品名	PAGE 页	PART NO. 型号	ITEM 品名
533				DB1-Z16	38		BC-DBZ(1)
535				DB1-Z16	38		BC-DBZ(1)
720				DB1-Z16	38		BC-DBZ(1)
721				DB1-Z16	38		BC-DBZ(1)
800	522514	○		DA1-B	38		BC-DB1
801	522514	○		DA1-B	38		BC-DB1
802				HNE-830	31		BC-DB1
803	522514	○		DA1-B	38		BC-DB1
810	522514	○		DA1-B	38		BC-DB1
812				HNE-830	31		BC-DB1
813	522514	○		DA1-B	38		BC-DB1
830				HNE-830	31		BC-DB1
831				HNE-830	31		BC-DB1
832	121524-4	○		HNE-835	31		BC-DB1-NBL6
835	121524-4	○		HNE-835	31		BC-DB1-NBL6
840				DB1-Z16	38		BC-DBZ(1)
881	121524-4	○		HNE-835	31		BC-DB1-NBL6
882	121524-4	○		HNE-835	31		BC-DB1-NBL6
883	121524-4	○		HNE-835	31		BC-DB1-NBL6
884	121524-4	○		HNE-835	31		BC-DB1-NBL6
885	121524-4	○		HNE-835	31		BC-DB1-NBL6
887	121524-4	○		HNE-835	31		BC-DB1-NBL6
RM	522514	○		DA1-B	38		BC-DB1
RVG	522514	○		DA1-B	38		BC-DB1
RVM	522514	○		DA1-B	38		BC-DB1
SG				HNE-830	31		BC-DB1
SM				HNE-830	31		BC-DB1
UAN-1501	522514	○		DA1-B	38		BC-DB1
UAN-1531				HNE-830	31		BC-DB1
POCKET SETTER				HSM-B(IE)	36		BC-DBM(1)

PEGASUS

MODEL	PART NO.	WITH BC/CAP	EX. ITEM	HIROSE HOOK		BOBBIN CASE	
				ITEM	PAGE	PART NO.	ITEM
DPS-2	179077000009			DP2	41	178081000009	BC-DP2(2)
DPS-3	179077000009			DP2	41	178081000009	BC-DP2(2)
DPS-4	179077000009			DP2	41	178081000009	BC-DP2(2)

PFAFF

MODEL 缝纫机机种	PART NO. 型号	WITH BC/CAP 配 BC/CP	EX. ITEM 专卖品	HIROSE HOOK 广濑梭头		BOBBIN CASE 梭芯套	
				ITEM 品名	PAGE 页	PART NO. 型号	ITEM 品名
27-55/11	91-004317-91			HPF-28	—		
28	91-004317-91			HPF-28	—		
38	91-005870-91			HPF-70	—		
114	91-008250-91	○		HPF-3114	42	91-008243-91	BC-PF3114
115	91-008250-91	○		HPF-3114	42	91-008243-91	BC-PF3114
116	91-008250-91	○		HPF-3114	42	91-008243-91	BC-PF3114
120	91-010165-91	○		HPF-151	43	91-010159-91	CP-HPF151
122	91-010165-91	○		HPF-151	43	91-010159-91	CP-HPF151
130				HPF-230(W)	39		BC-PF9076(14)
130	91-064662-91	○		HPF-238	39	91-009076-91	BC-PF9076
133	91-009246-91	○		HPF-134	39	91-009076-91	BC-PF9076
134	91-009246-91	○		HPF-134	39	91-009076-91	BC-PF9076
138	91-105490-91	○		HPF-335	39	91-009076-91	BC-PF9076
138				HPF-230(W)	39		BC-PF9076(14)
138	91-064662-91	○		HPF-238	39	91-009076-91	BC-PF9076
141~146	91-010896-91	○		HPF-144	—	91-010159-91	CP-HPF151
141~146	91-010165-91	○		HPF-151	43	91-010159-91	CP-HPF151
141~146	91-010850-91	○		HPF-145	—	91-010159-91	CP-HPF151
175-196	91-010896-91	○		HPF-144	—	91-010159-91	CP-HPF151
175-196	91-010165-91	○		HPF-151	43	91-010159-91	CP-HPF151
175-196	91-010850-91	○		HPF-145	—	91-010159-91	CP-HPF151
151	91-010165-91	○		HPF-151	43	91-010159-91	CP-HPF151
155	91-010165-91	○		HPF-151	43	91-010159-91	CP-HPF151
142-720	91-010165-91	○		HPF-151	43	91-010159-91	CP-HPF151
142-721	91-010165-91	○		HPF-151	43	91-010159-91	CP-HPF151
142-900	91-113414-91	○		HPF-151TR	—	91-140650-91	CP-HPF151TR
142-720-900	91-113414-91	○		HPF-151TR	—	91-140650-91	CP-HPF151TR
142-721-900	91-113414-91	○		HPF-151TR	—	91-140650-91	CP-HPF151TR
144	91-113190-91	○		HPF-144TR	—	91-113192-91	CP-HPF144TR
191~196	91-010165-91	○		HPF-151	43	91-010159-91	CP-HPF151
194-720	91-010165-91	○		HPF-151	43	91-010159-91	CP-HPF151
190	91-015023-91	○		HPF-190	—		CP-HPF190
230	91-064662-91	○		HPF-238	39	91-009076-91	BC-PF9076
234	91-063090-91	○		HPF-234	39	91-009076-91	BC-PF9076
234	91-105490-91	○		HPF-335	39	91-009076-91	BC-PF9076
238	91-064661-91	○		HPF-238	39	91-009076-91	BC-PF9076
331	91-105490-91	○		HPF-335	39	91-009076-91	BC-PF9076
333	91-105490-91	○		HPF-335	39	91-009076-91	BC-PF9076
335	91-105490-91	○		HPF-335	39	91-009076-91	BC-PF9076
337-734	91-105490-91	○		HPF-335	39	91-009076-91	BC-PF9076
335H-2	91-105490-91	○		HPF-335	39	91-009076-91	BC-PF9076
341-347	91-014192-91	○		HPF-345	—	91-010159-91	CP-HPF151
353-354	91-014192-91	○		HPF-345	—	91-010159-91	CP-HPF151
390				HPF-390	—		CP-HPF190
417~419	91-168888-91	○		HPF-418	35	91-168628-91	BC-PF418
417-900~419-900	91-168888-91	○		HPF-418	35	91-168628-91	BC-PF418
437~439	91-168885-91	○		HPF-438	39	91-009076-91	BC-PF9076
437~439				HPF-438(GR)	39	91-009076-91	BC-PF9076

SEIKO

MODEL 缝纫机机种	PART NO. 型号	WITH BC/CAP 配 BC/CP	EX. ITEM 专卖品	HIROSE HOOK 广濑梭头		BOBBIN CASE 梭芯套	
				ITEM 品名	PAGE 页	PART NO. 型号	ITEM 品名
BBW-series	994485			HAD-467TR(1B)	52		
BEW-series	994485			HAD-467TR(1B)	52		
CH-series	28837C			HAD-204	51		
CH-series	28091C			HAD-204(OP)	51		
CK-1	2530			HSH-33	52		
CW-series	13086			HSH-31(B)	43		
H-2B,-2BL	18849			HSM-A1	35		BC-DBM(1)-NBL1
HC-2B	19985			HPF-335(5)	39		BC-PF9076-NBL
LCW-8BL	13719			HSH-31MMB(5)	48		
LCW-8BL-1	13719			HSH-31MMB(5)	48		
LLW-8BL	15040			HSH-12-15MM(5)	49		
LLW-8BL-TA	15040			HSH-12-15MM(5)	49		
LLW-8L	15040			HSH-12-15MM(5)	49		
LLW-8L-TA	15040			HSH-12-15MM(5)	49		
LLW-28	15502			HSH-12-15MMB(5)	49		
LLW-28BL	15502			HSH-12-15MMB(5)	49		
LLW-28BL-TA	15040			HSH-12-15MM(5)	49		
LLW-28L	15502			HSH-12-15MMB(5)	49		
LLW-28L-TA	15040			HSH-12-15MM(5)	49		
LPW-6,-6B	12032			HSH-31(12)	43		
LPW-7,-7B	12032			HSH-31(12)	43		
LPW-8,-8B	12032			HSH-31(12)	43		
LPW-26	12530			HSH-31(B12)	43		
LPW-26B	12530			HSH-31(B12)	43		
LPW-27	12530			HSH-31(B12)	43		
LPW-27B	12530			HSH-31(B12)	43		
LPW-28	12530			HSH-31(B12)	43		
LPW-28B	12530			HSH-31(B12)	43		
LSC-8B	17033			HPF-335(5)	39		BC-PF9076-NBL
LSC-8BV	17033			HPF-335(5)	39		BC-PF9076-NBL
LSW-6L	15040			HSH-12-15MM(5)	49		
LSW-6L-G	15850			HSH-12MC(5)	50	15850-09	CP-12MC(5)
LSW-7BL	15040			HSH-12-15MM(5)	49		
LSW-7BL-T	15040			HSH-12-15MM(5)	49		
LSW-7L	15040			HSH-12-15MM(5)	49		
LSW-7L-G	15850			HSH-12MC(5)	50	15850-09	CP-12MC(5)
LSW-7L-T	15040			HSH-12-15MM(5)	49		
LSW-8	15255			HSH-11-55M	-		
LSW-8B	15255			HSH-11-55M	-		
LSW-8BL	15040			HSH-12-15MM(5)	49		
LSW-8BL-T	15040			HSH-12-15MM(5)	49		
LSW-8BLM	15040			HSH-12-15MM(5)	49		
LSW-8BLV	15040			HSH-12-15MM(5)	49		
LSW-8BLVMF	15040			HSH-12-15MM(5)	49		
LSW-8BLVP	15040			HSH-12-15MM(5)	49		
LSW-8L	15040			HSH-12-15MM(5)	49		
LSW-8L-T	15040			HSH-12-15MM(5)	49		

SEIKO

MODEL 縫紉機機種	PART NO. 型号	WITH BC/CAP 配BC/CP	EX. ITEM 専用品	HIROSE HOOK 广濑梭头		BOBBIN CASE 梭芯套	
				ITEM 品名	PAGE 页	PART NO. 型号	ITEM 品名
LSW-8LM	15040			HSH-12-15MM(5)	49		
LSW-8LV	15040			HSH-12-15MM(5)	49		
LSW-8LVMF	15040			HSH-12-15MM(5)	49		
LSW-8LVP	15040			HSH-12-15MM(5)	49		
LSW-26BL	15040			HSH-12-15MM(5)	49		
LSW-26BL-R	15850			HSH-12MC(5)	50	15850-09	CP-12MC(5)
LSW-27BL	15502			HSH-12-15MMB(5)	49		
LSW-27BLK	16407			HSH-12MCA(5)	50	15850-09	CP-12MC(5)
LSW-27L	15502			HSH-12-15MMB(5)	49		
LSW-28BL	15502			HSH-12-15MMB(5)	49		
LSW-28BLK	16407			HSH-12MCA(5)	50	15850-09	CP-12MC(5)
LSW-28L	15502			HSH-12-15MMB(5)	49		
LTW-26	11124			HSH-12-15L	46		
LTW-27	11124			HSH-12-15L	46		
LTW-27BK	16291			HSH-12-15LC	46	16291-06	CP-12C
LTW-27BLM	15502			HSH-12-15MMB(5)	49		
LTW-27BM	11124			HSH-12-15L	46		
NCL-2BL	18849			HSM-A	35	18550	BC-DBM(1)
PW-6	12032			HSH-31(12)	43		
PW-6B	12032			HSH-31(12)	43		
PW-7	12032			HSH-31(12)	43		
PW-7B	12032			HSH-31(12)	43		
PW-26B	12530			HSH-31(B12)	43		
PW-27B	12530			HSH-31(B12)	43		
PW-28B	12530			HSH-31(B12)	43		
PWB-8GW	37256			HPF-490(A)	43		CP-HPF151
PWB-8GWC	37735			HPF-490(5)TR	43		CP-HPF144TR
PWB-8GWC-FL	37735			HPF-490(5)TR	43		CP-HPF144TR
PWB-8GWC-LC	37735			HPF-490(5)TR	43		CP-HPF144TR
PWB-8W	37255			HPF-490	43		CP-HPF151
SK-series	1343			HSH-32	52		
SKM-26	1526			HSH-32(26)	52		
SKM-36	1526			HSH-32(26)	52		
SLH-series	35222			HSH-7-3	51		
STH-series	18033			HSM-A(5)	35	18045	BC-STH
STW-6	10655			HSH-11-55	45		
STW-7	10655			HSH-11-55	45		
STW-8	10655			HSH-11-55	45		
STW-8BM	10945			HSH-11-55B	-		
STW-8BV	10655			HSH-11-55	45		
STW-8M	10945			HSH-11-55B	-		
STW-8V	10655			HSH-11-55	45		
STW-26	10945			HSH-11-55B	-		
STW-27	10945			HSH-11-55B	-		
STW-28	10945			HSH-11-55B	-		
TE-series	8028			TF1	51		
TF-series	8028			TF1	51		
TH-series	28837C			HAD-204	51		

SINGER

MODEL 缝纫机机种	PART NO. 型号	WITH BC/CAP 配 BC/CP	EX. ITEM 专卖品	HIROSE HOOK 广濑梭头		BOBBIN CASE 梭芯套	
				ITEM 品名	PAGE 页	PART NO. 型号	ITEM 品名
17	547772			TF1	51		
281	32389	○		HSH-7.94B(281)	—	52237	BC-DB1
281	143342	○		HSH-7.94C	33	52237	BC-DB1
281	149173	○		HSH-7.94B(AC)	31	52237	BC-DB1
281	545991	○		HSH-7.94B(391)	31	52237	BC-DB1
281	143342FG	○		HSH-7.94B	31	52237	BC-DB1
281	143342FG	○		HSH-7.94BN	32	52237	BC-DB1
281	143342LS	○		HSH-7.94CO	33	52237	BC-DB1
281	143342SN	○		HSH-7.94C(L)	33	52237	BC-DB1
281	143342SNS	○		HSH-7.94D	34	52237	BC-DB1
281	143342TS	○		HSH-7.94C(TS)	33	52237	BC-DB1
366	143342FG	○		HSH-7.94B	31	52237	BC-DB1
369	239727	○		HSM-B(Q)TR	36	239728	BC-DBM(3)-NBL2
660	174091	○		HSH-7.94B(660)	31	52237	BC-DB1
770	513170	○		HSH-7.94B(7)	31	522312	BC-770
97-2	58786			HSH-7-2	—		
7-27	58662(19568)			HSH-7-7R	—		
7-27	58665(19560)			HSH-7-7L	—		
11-11	14530/14528			HSH-1-1	51		
103K	52089 (142020)	○		DA2-A (TA1-A)	38	52237	BC-DB1
103K	52089 (142020)	○		DA2-C (TA1-C)	38	52237	BC-DB1
103K	52089FG (142020FG)	○		DA2-B (TA1-B)	38	52237	BC-DB1
107G	224443	○		DP2-L(N)	42	224441	BC-DP2(2)
107G	224459	○		DP2	41	224441	BC-DP2(2)
107G	224459HSB	○		DP2-HSP	—	224441	BC-DP2(2)
107W1/3/5/17	224443	○		DP2-L(N)	42	224441	BC-DP2(2)
107W1/3/5/17	224459	○		DP2	41	224441	BC-DP2(2)
107W1/3/5/17	224459HSB	○		DP2-HSP	—	224441	BC-DP2(2)
107W100/102/103	224325	○		HSH-102	42	224418	BC-102
108K	224750			HSH-8-20	42		
108K	244088			HSH-8-20(K)	42		
110K	237796			HSH-10-100(A)	43		
110K	237796FG			HSH-10-100	43		
110W124/128	237796			HSH-10-100(A)	43		
110W124/128	237796FG			HSH-10-100	43		
110W-2	247675	○		HSH-19	43	241676	CP-18
111W100/102/103/113	240207			HSH-11-53	45		
111W150/151	240240			HSH-11-51	45		
111W153/154	240207			HSH-11-53	45		
111W155/156	240558			HSH-11-55	45		
111W155/156	240558HP			HSH-11-55HP	—		
112W110	240091			HSH-12-15(A)	46		
112W115-139	34797	○		HSH-12-68	46	237168	CP-68
112W115-139	240091			HSH-12-15(A)	46		
112W115-139	237204			HSH-12-15	46		
112W140/145/146	248463			HSH-12-40	46		
118W	235797	○		HSH-18-4	43	241676	CP-18
119W	247675	○		HSH-19	43	241676	CP-18
121C330AA	239727	○		HSM-B(Q)TR	36	530198	BC-DBM(3)-NBL2

SINGER

MODEL 缝纫机机种	PART NO. 型号	WITH BC/CAP 配 BC/CP	EX. ITEM 专用品	HIROSE HOOK 广濑梭头		BOBBIN CASE 梭芯套	
				ITEM 品名	PAGE 页	PART NO. 型号	ITEM 品名
121D330AA	239727	○		HSM-B(Q)TR	36	530198	BC-DBM(3)-NBL2
131W	236121			HSH-31(12)	43		
131W	238250			HSH-31	43		
131W	244521			HSH-31(B)	43		
131W103/104/110/113	236121			HSH-31(12)	43		
132K	103123			HSH-32	52		
133K	103120			HSH-33	52		
133W103	240904	○		HSH-51-33	—	224418	BC-102
134W	264725			HSH-34-4L	—		
134W	264726			HSH-34-4R	—		
136W	34799	○		HSH-5-16(B)	—	241676	CP-18
136W	249118	○		HSH-36-1	43	241676	CP-18
136W	264161	○		HSH-5-16	44	241676	CP-18
138G101	34815	○		HSH-68-1(B)	—	237168	CP-68
138G102	264161	○		HSH-5-16	44	241676	CP-18
138G103	34816	○		HSH-80-2	—	264256	CP-80
138W102	264161	○		HSH-5-16	44	241676	CP-18
143W1	224443	○		DP2-L(N)	42	224441	BC-DP2(2)
144W	265361			HSH-445	50		
144W	265361HP			HSH-445(SP)	50		
145W	265361			HSH-445	50		
145W	265361HP			HSH-445(SP)	50		
151K	224579	○		HSH-51-1	42	224441	BC-DP2(2)
151W	224579	○		HSH-51-1	42	224441	BC-DP2(2)
153K	238250			HSH-31	43		
153W	238250			HSH-31	43		
167G/W	264414	○		HSH-68-1	44	237168	CP-68
180W201	264245	○		HSH-80-2	—	264256	CP-80
188U	546794	○		HSH-7.94B(188UL)	40	52237	BC-DB1
18U	547772			TF1	51		
191D200AA	414126	○		HSH-7.94B	31	52237	BC-DB1
191D300AA	414126	○		HSH-7.94B	31	52237	BC-DB1
191D300BA	414126	○		HSH-7.94B	31	52237	BC-DB1
195K	174046	○		DA1-A(7.94)	38	52237	BC-DB1
196K	174046	○		DA1-A(7.94)	38	52237	BC-DB1
20U13/23	541674	○		DB1-BZ(20)	38	541678NBL	BC-DBZ(3)-NBL6
20U13/23	541968	○		DB1-Z(20)	38	541678NBL	BC-DBZ(3)-NBL6
20U31/33/34	410140	○		DB1-BZ(20L)	38	541678NBL	BC-DBZ(3)-NBL6
20U43	410054	○		DB1-Z(20L)	38	541678NBL	BC-DBZ(3)-NBL6
20UX143	410054	○		DB1-Z(20L)	38	541678NBL	BC-DBZ(3)-NBL6
2110X104/106	510008			HSH-12-15MM(S)	48		
211A	CH319995			HSH-12-15M	46		
211G146/151	244711			HSH-21-40	47		
211G146/151	244711HP			HSH-21-40(HP)	47		
211G155/156	240558			HSH-11-55	45		
211G155/156	240558HP			HSH-11-55HP	—		
211G157/157A/158	244711			HSH-21-40	47		
211G166	244711			HSH-21-40	47		
211G166	244711HP			HSH-21-40(HP)	47		

SINGER

MODEL 缝纫机机种	PART NO. 型号	WITH BC/CAP 配 BC/CP	EX. ITEM 专卖品	HIROSE HOOK 广濑梭头		BOBBIN CASE 梭芯套	
				ITEM 品名	PAGE 页	PART NO. 型号	ITEM 品名
211G265/266	244711			HSH-21-40	47		
211G351/357/358	514200	○		HPF-545S	—	514241	CP-212BIG
211G451/457	34804	○		HSH-21-40TR	47	512551	CP-212
211G465/466	514200	○		HPF-545S	—	514241	CP-212BIG
211G557/558/566A	510008			HSH-12-15MM(S)	48		
211G665/666	34823	○		HSH-21-40TR(S)	—	512551	CP-212
211G765/766	514200	○		HPF-545S	—	514241	CP-212BIG
211G866A/867A	510008			HSH-12-15MM(S)	48		
211GX101	34823	○		HSH-21-40TR(S)	—	512551	CP-212
211GX102	514200	○		HPF-545S	—	514241	CP-212BIG
211GX103	34823	○		HSH-21-40TR(S)	—	512551	CP-212
211GX108	514200	○		HPF-545S	—	514241	CP-212BIG
211GX109	510008			HSH-12-15MM(S)	48		
211GX110	244711			HSH-21-40	47		
211GX112	34823	○		HSH-21-40TR(S)	—	512551	CP-212
211GX114	510008			HSH-12-15MM(S)	48		
211GX115	244711			HSH-21-40	47		
211U157	244711			HSH-21-40	47		
211U157	244711HP			HSH-21-40(HP)	47		
211U165/166	240558			HSH-11-55	45		
211U165/166	240558HP			HSH-11-55HP	—		
211U257	244711			HSH-21-40	47		
211U257	244711HP			HSH-21-40(HP)	47		
211U341/365	240558			HSH-11-55	45		
211U341/365	240558HP			HSH-11-55HP	—		
211U566	510008			HSH-12-15MM(S)	48		
211U567	412307			HSH-12-15MMJ(A)	49		
211U866	510008			HSH-12-15MM(S)	48		
211U867	412307			HSH-12-15MMJ(A)	49		
211UX157	244711			HSH-21-40	47		
211UX157	244711HP			HSH-21-40(HP)	47		
211UX165/166	240558			HSH-11-55	45		
211UX165/166	240558HP			HSH-11-55HP	—		
211UX566	510008			HSH-12-15MM(S)	48		
211UX567	412307			HSH-12-15MMJ(A)	49		
211W151/155	240558			HSH-11-55	45		
211W151/155	240558HP			HSH-11-55HP	—		
212A141BA	CH319995			HSH-12-15M	46		
212A141GA	CH319995			HSH-12-15M	46		
212A939JA	281049			HSH-12-15MMB(5)S	—		
212A939JB	281049			HSH-12-15MMB(5)S	—		
212G140/141/145/440	34804	○		HSH-21-40TR	47	512551	CP-212
212G140/141/145/440	244711HP			HSH-21-40(HP)	47		
212G140/141/145/440	267357			HSH-21-40	47		
212G441	34823	○		HSH-21-40TR(S)	—	512551	CP-212
212G539/541	510008			HSH-12-15MM(S)	48		
212G641	514200	○		HPF-545S	—	514241	CP-212BIG
212GX101/103	34823	○		HSH-21-40TR(S)	—	512551	CP-212
212GX102/104	514200	○		HPF-545S	—	514241	CP-212BIG
212GX106	510008			HSH-12-15MM(S)	48		

SINGER

MODEL 缝纫机机种	PART NO. 型号	WITH BC/CAP 配 BC/CP	EX. ITEM 专卖品	HIROSE HOOK 广濑梭头		BOBBIN CASE 梭芯套	
				ITEM 品名	PAGE 页	PART NO. 型号	ITEM 品名
212GX107	34823	○		HSH-21-40TR(S)	—	512551	CP-212
212GX108/110	514200	○		HPF-545S	—	514241	CP-212BIG
212GX114	510008			HSH-12-15MM(S)	48		
212GX4/5/6	267357			HSH-21-40	47		
212GX8	514200	○		HPF-545S	—	514241	CP-212BIG
212LX670	267357			HSH-21-40	47		
212U143A/144	412433	○		HSH-21-40(S)C	47	412440	CP-12C
212U41/442	267357			HSH-21-40	47		
212U441	514109	○		HSH-21-40TR	47	512551	CP-212
212U443A/444	412433	○		HSH-21-40(S)C	47	412440	CP-12C
212U539A/839A	412307			HSH-12-15MMJ(A)	49		
212U543A/544	416520	○		HSH-12-15MM(S)C	48	416523	CP-12MC(S)
212U841A	510008			HSH-12-15MM(S)	48		
212U843A	416520	○		HSH-12-15MM(S)C	48	416523	CP-12MC(S)
212W140/145/146	267357			HSH-21-40	47		
212W140/145/146	244711HP			HSH-21-40(HP)	47		
21W162	203290	○		HSH-2-12	43	236853	CP-2
21W162	203804			HSH-22-21	43		
21W162	237796			HSH-10-100(A)	43		
21W162	237796FG			HSH-10-100	43		
21W180/182	238250			HSH-31	43		
220U22	414126	○		HSH-7.94B	31	52237	BC-DB1
220U23	414126	○		HSH-7.94B	31	52237	BC-DB1
22W	230290	○		HSH-2-12	43	236853	CP-2
236G120/124/125	263464	○		HSH-36-2	44	241676	CP-18
236G130/131/132	263464	○		HSH-36-2	44	241676	CP-18
236W	263464	○		HSH-36-2	44	241676	CP-18
238G	241691	○		HSH-5-16(B)	—	241676	CP-18
271K	107122	○		DP2-71	41	271785	BC-271
281-181/183/41	545991	○		HSH-7.94B(391)	31	52237	BC-DB1
291U	545991	○		HSH-7.94B(391)	31	52237	BC-DB1
391U	545990	○		HSH-7.94B(391)	31	52237	BC-DB1
400W/402W/451K	143342	○		HSH-7.94C	33	52237	BC-DB1
400W/402W/451K	143342FG	○		HSH-7.94B	31	52237	BC-DB1
400W/402W/451K	143342FG	○		HSH-7.94BN	32	52237	BC-DB1
400W/402W/451K	143342LS	○		HSH-7.94CO	33	52237	BC-DB1
400W/402W/451K	143342SN	○		HSH-7.94C(L)	33	52237	BC-DB1
400W/402W/451K	143342SNS	○		HSH-7.94D	34	52237	BC-DB1
400W/402W/451K	143342TS	○		HSH-7.94C(TS)	33	52237	BC-DB1
400W/402W/451K	414424	○		HSH-7.94A	31	52237	BC-DB1
412U	554507			HSH-12-15M	46		
457A	282293	○		DP2-457U(T)	41	502530	BC-DP57
457G	34822	○		DP2-57(2LP)	41	502530	BC-DP57
457G	34822	○		DP2-57(2LPRP)	41	502530	BC-DP57
457G	502718	○		DP2-57(2)	41	502530	BC-DP57
457G	34802HP	○		DP2-457LHP	41	502530	BC-DP57
457G	502718HP	○		DP2-457HP	41	502530	BC-DP57
457G	502718RP	○		DP2-57(2RP)	41	502530	BC-DP57
457U	417664	○		DP2-457UTT	—	502530	BC-DP57
45K	98622			DD1	51		

SINGER

MODEL 缝纫机机种	PART NO. 型号	WITH BC/CAP 配BC/CP	EX. ITEM 专卖品	HIROSE HOOK 广濑梭头		BOBBIN CASE 梭芯套	
				ITEM 品名	PAGE 页	PART NO. 型号	ITEM 品名
45K	98623			DD1-OP	51		
46W	238250			HSH-31	43		
47W70	244521			HSH-31(B)	43		
491D100GA/200GA	414126	○		HSH-7.94B	31	52237	BC-DB1
491D300GA/308GA	414126	○		HSH-7.94B	31	52237	BC-DB1
491UX100/110B/G/H	540733	○		HSH-7.94BTR(491)	33	52237NBL	BC-DB1-NBL6
491UX200/210B/G/H	540733	○		HSH-7.94BTR(491)	33	52237NBL	BC-DB1-NBL6
491UX300/310B/G/H	540733	○		HSH-7.94BTR(491)	33	52237NBL	BC-DB1-NBL6
51W	241691	○		HSH-5-16(B)	—	241676	CP-18
52K	264161	○		HSH-5-16	44	241676	CP-18
52W22	264161	○		HSH-5-16	44	241676	CP-18
52W30/31	238250			HSH-31	43		
591C200	414070	○		HSH-7.94BTR(591B)	33	52237NBL	BC-DB1-NBL6
591C200	543381	○		HSH-7.94B(KSN)	32	52237NBL	BC-DB1-NBL6
591C210BD/BF/GD/GF	414070	○		HSH-7.94BTR(591B)	33	52237NBL	BC-DB1-NBL6
591C240	414070	○		HSH-7.94BTR(591B)	33	52237NBL	BC-DB1-NBL6
591C240AD/AF	543381	○		HSH-7.94B(KSN)	32	52237NBL	BC-DB1-NBL6
591C300	543381	○		HSH-7.94B(KSN)	32	52237NBL	BC-DB1-NBL6
591C300BD/BF/GD/GF	414070	○		HSH-7.94BTR(591B)	33	52237NBL	BC-DB1-NBL6
591C318BD/BF/GD/GF	414070	○		HSH-7.94BTR(591B)	33	52237NBL	BC-DB1-NBL6
591D200	544784	○		HSH-7.94BTR(591D)	33	52237NBL	BC-DB1-NBL6
591D203/205	414126	○		HSH-7.94B	31	52237	BC-DB1
591D210BD/BF/GD/GF	544784	○		HSH-7.94BTR(591D)	33	52237NBL	BC-DB1-NBL6
591D215	544784	○		HSH-7.94BTR(591D)	33	52237NBL	BC-DB1-NBL6
591D240AD/AF	414126	○		HSH-7.94B	31	52237	BC-DB1
591D240BF/GD/GF	544784	○		HSH-7.94BTR(591D)	33	52237NBL	BC-DB1-NBL6
591D30/302/303/3051	414126	○		HSH-7.94B	31	52237	BC-DB1
591D300	544784	○		HSH-7.94BTR(591D)	33	52237NBL	BC-DB1-NBL6
591D308AD/AF	543381	○		HSH-7.94B(KSN)	32	52237NBL	BC-DB1-NBL6
591D310BD/BF/GD/GF	544784	○		HSH-7.94BTR(591D)	33	52237NBL	BC-DB1-NBL6
591D315	544784	○		HSH-7.94BTR(591D)	33	52237NBL	BC-DB1-NBL6
591D318BD/BF/GD/GF	544784	○		HSH-7.94BTR(591D)	33	52237NBL	BC-DB1-NBL6
591DUX100	414126	○		HSH-7.94B	31	52237	BC-DB1
591U	414430	○		HSH-7.94BTR(591DT)	33	52237NBL	BC-DB1-NBL6
591UX100	544784	○		HSH-7.94BTR(591D)	33	52237NBL	BC-DB1-NBL6
591UX220	544784	○		HSH-7.94BTR(591D)	33	52237NBL	BC-DB1-NBL6
591UX312	544784	○		HSH-7.94BTR(591D)	33	52237NBL	BC-DB1-NBL6
591UX313BF/GF	544784	○		HSH-7.94BTR(591D)	33	52237NBL	BC-DB1-NBL6
591UX320GF	544784	○		HSH-7.94BTR(591D)	33	52237NBL	BC-DB1-NBL6
600W	143342FG	○		HSH-7.94B	31	52237	BC-DB1
601D100AD/AF/BD	414430(544784)	○		HSH-7.94BTR(591D)	33	52237NBL	BC-DB1-NBL6
601D100BF/GD/GF	414430(544784)	○		HSH-7.94BTR(591D)	33	52237NBL	BC-DB1-NBL6
691D	368132	○		HSH-7.94BTR	32	52237NBL	BC-DB1-NBL6
7-31/33/56	58669			HSH-7-3	51		
95-10/96-10	52089 (142020)	○		DA2-A(TA1-A)	38	52237	BC-DB1
95-10/96-10	52089 (142020)	○		DA2-B(TA1-B)	38	52237	BC-DB1
95-10/96-10	52089FG (142020FG)	○		DA2-C(TA1-C)	38	52237	BC-DB1
95-40/96-40	127119	○		DA1-A	38	52237	BC-DB1
95-40/96-40	127119	○		DA1-C	38	52237	BC-DB1
95-40/96-40	127119FG	○		DA1-B	38	52237	BC-DB1

STAGER

MODEL 缝纫机机种	PART NO. 型号	WITH BC/CAP 配 BC/CP	EX. ITEM 专卖品	HIROSE HOOK 广濑梭头		BOBBIN CASE 梭芯套	
				ITEM 品名	PAGE 页	PART NO. 型号	ITEM 品名
SE-12				DB1-Z16	38		BC-DBZ(1)
SZ-21-1N				DB1-Z16	38		BC-DBZ(1)
SZ-21-2N				DB1-Z16	38		BC-DBZ(1)
SZ-21-3N				DB1-Z16	38		BC-DBZ(1)
SZ-21-4N				DB1-Z16	38		BC-DBZ(1)
SZ-21-5N				DBM-A(Z14)	35		BC-DBM(Z1)
SZ-21-1BN				DBM-A(Z14)	35		BC-DBM(Z1)
SZ-21-1BNL				DBM-A(Z14)	35		BC-DBM(Z1)
SZ-21-3BNL				DBM-A(Z14)	35		BC-DBM(Z1)
SZ-21-4BNL				DBM-A(Z14)	35		BC-DBM(Z1)
SZ-21-5N				DBM-A(Z14)	35		BC-DBM(Z1)
S2-21-5-3N				DBM-A(Z14)	35		BC-DBM(Z1)
S2-21-5-4N				DBM-A(Z14)	35		BC-DBM(Z1)
S2-21-5-5WN				DBM-A(Z14)	35		BC-DBM(Z1)
SZ-21-5NL				DBM-A(Z14)	35		BC-DBM(Z1)
SZ-21-5-3NL				DBM-A(Z14)	35		BC-DBM(Z1)
SZ-21-5-4NL				DBM-A(Z14)	35		BC-DBM(Z1)
SZ-25N				DB1-Z16	38		BC-DBZ(1)
SZ-72N				DB1-Z16	38		BC-DBZ(1)
SZ-72N-8N				DB1-Z16	38		BC-DBZ(1)
SZ-310-1N				DP2-57(2LPA)	41		BC-DP57
SZ-310-3N				DP2-57(2LPA)	41		BC-DP57
SZ-310-4N				DP2-57(2LPA)	41		BC-DP57
SZ-310-5-1N				DP2-57(2LPA)	41		BC-DP57
SZ-310-5-3N				DP2-57(2LPA)	41		BC-DP57
SZ-310-5-4N				DP2-57(2LPA)	41		BC-DP57
SZ-310-5-1WN				DP2-57(2LPA)	41		BC-DP57
SZ-310-11N				DP2-57(2LPA)	41		BC-DP57

TAJIMA

MODEL	PART NO.	WITH BC/CAP	EX. ITEM	HIROSE HOOK			BOBBIN CASE	
				GENUINE	ALTERNATIVE	PAGE	PART NO.	ITEM
TFGN-	050210140016		※	HSL-ATR(MTQETA)	HSH-7.94ATR(MTQ)	40		BC-DBZ(3)NBL6
TFKN-	050210150000		※	HSL-ATR(MTQEL)/TA	HSH-7.94ATR(MTQL)	—		BC-DBZ(3)NBL6
TFMX	05022006J016		※	HSM-ATR(MTQETA)	HSM-ATR(MTQ)	40		BC-DBM(Z2)NBL5
TFMX-II	050220080024		※	HSM-ATR(MTQEL)/TA	HSM-ATR(MTQL)	—		BC-DBM(Z2)NBL5
TFGN-C	050210160016		※	HSL-ATR(MTQTA)	HSH-7.94ATR(MTQ)	40		BC-DBZ(3)NBL6
TFMX-II C	05022009J016		※	HSM-ATR(MTQTA)	HSM-ATR(MTQ)	40		BC-DBM(Z2)NBL5
TFMX-C								
TFJT-C								

TOYOTA

MODEL 缝纫机机种	PART NO. 型号	WITH BC/CAP 配 BC/CP	EX. ITEM 专卖品	HIROSE HOOK 广濑梭头		BOBBIN CASE 梭芯套	
				ITEM 品名	PAGE 页	PART NO. 型号	ITEM 品名
AD150	2113004-310			HSH-7.94B	31	2110104-3010	BC-DB1
AD150G	2110904-310			HSH-7.94BOH(4)	—	2110104-301C	BC-DB1
AD156	2120604-310			HSH-7.94B	31	2110104-301C	BC-DB1
AD156G	2110904-310			HSH-7.94BOH(4)	—	2110104-301C	BC-DB1
AD156M	2120604-310			HSH-7.94B	31	2110104-301C	BC-DB1
AD340-22	2111104-310			HSH-7.94BTR	32	2110604-301B	BC-DB1-NBL2
AD1202K	2114304-310B			HSH-7.94BTR(4HP)	—	2110604-301B	BC-DB1-NBL2
AD1203V	2114314-310			HSH-7.94BTR(4RP)	—	2110604-301B	BC-DB1-NBL2
AD3110	2123704-310A			HSH-12-15MMB(5)TR4	49		
AD320-22	2122314-310			HSM-A1HTR(4)	—	2122304-310B	BC-DBM(2)-NBL1
AD3310	2123704-310A			HSH-12-15MMB(5)TR4	49		
AD331L	2121414-310A			HSH-12-15MM(5)SS	49		
AD331LP	2121414-310A			HSH-12-15MM(5)SS	49		
AD3320	2123704-310A			HSH-12-15MMB(5)TR4	49		
AD332L	2121414-310A			HSH-12-15MM(5)SS	49		
AD332LP	2121414-310A			HSH-12-15MM(5)SS	49		
AD340	2121604-310B			HSH-7.94BSN(4)	—	2121604-301B	BC-DLN-NBL
AD340B	2121614-310			HSH-7.94BOHNTR	32	2110604-301B	BC-DB1-NBL2
AD340B-22	2121614-310			HSH-7.94BOHNTR	32	2110604-301B	BC-DB1-NBL2
AD341	2121604-310B			HSH-7.94BSN(4)	—	2121604-301B	BC-DLN-NBL
AD345	2120604-310			HSH-7.94B	31	2110104-301C	BC-DB1
AD345-22	2111104-310			HSH-7.94BTR	32	2110604-301B	BC-DB1-NBL2
AD352	2120604-310			HSH-7.94B	31	2110104-301C	BC-DB1
AD550	2130504-310			DP2-57(T)	—	2130704-301A	BC-DP57
AD551	2130504-310			DP2-57(T)	—	2130704-301A	BC-DP57
AD552	2130704-310A			DP2-57(2LPTC)	—	2130704-301A	BC-DP57
AD553	2130714-310			DP2-57(2LPTB)	—	2130704-301A	BC-DP57
AD740	2140114-310			HSH-21-40(T)	—		
D324	2120304-310B			HSM-B	36	2120304-301	BC-DBM(1)
D530	2130104-300B			HSM-B(Z17)	36	2130104-301A	BC-DBM(Z1)
D530E	2130104-300B			HSM-B(Z17)	36	2130104-301A	BC-DBM(Z1)
D532	2130104-300B			HSM-B(Z17)	36	2130104-301A	BC-DBM(Z1)
D533	2130104-300B			HSM-B(Z17)	36	2130104-301A	BC-DBM(Z1)
D534	2130104-300B			HSM-B(Z17)	36	2130104-301A	BC-DBM(Z1)

TREASURE

MODEL	PART NO.	WITH BC/CAP	EX. ITEM	HIROSE HOOK		BOBBIN CASE	
				ITEM	PAGE	PART NO.	ITEM
BS-170				HLE-170	52		
BS-1700				HLE-170	52		
BS-170C				HLE-170	52		
BS-170J				HLE-170	52		
BS-170LA				HLE-170	52		
BS-170PB				HLE-170	52		
BS-170SF				HLE-170	52		
BS-171				HLE-170	52		
BS-172				HLE-170	52		

UNION SPECIAL

MODEL 缝纫机机种	PART NO. 型号	WITH BC/CAP 配 BC/CP	EX. ITEM 专卖品	HIROSE HOOK 广濑梭头		BOBBIN CASE 梭芯套	
				ITEM 品名	PAGE 页	PART NO. 型号	ITEM 品名
16	1040A-1L			HLE-16	52		
16	1040A-2L			HLE-16(170UN)	52		
30	906A-1L			HLE-30(UN)	52		
170	409-27-1			HLE-170	52		
61200/61200 61400/61900 93400/63900	61407BFG	○		HUN-614B	34	61413E	BC-UN614E
	61407BFGSN	○		HUN-614B(L)	34		BC-DB1
	61407B	○		HUN-614C	34	61413E	BC-UN614E
	61407BSN	○		HUN-614C(L)	34		BC-DB1
	61407BTS	○		HUN-614C(TS)	34	61413E	BC-UN614E
61800/62200	29474AC			HUN-622	47		
63900AML	29474AH	○		HTH-614BTR(QE)	34	63913E	BC-HTH(E)-U
63900AML	K74753	○		HTH-614BTR(1.7QE)	34	63913E	BC-HTH(E)-U

YAMATO

MODEL	PART NO.	WITH BC/CAP	EX. ITEM	HIROSE HOOK		BOBBIN CASE	
				ITEM	PAGE	PART NO.	ITEM
DP-2	75126			DP2	41	75128	BC-DP2(2)
DP-2	76626			DP2(HS)	41	75128	BC-DP2(2)
DP-3	75126			DP2	41	75128	BC-DP2(2)
DP-3	76626			DP2(HS)	41	75128	BC-DP2(2)
DP-1101	77305			HDU-265Y	39	77309	BC-HDU265
DP-1102	77305			HDU-265Y	39	77309	BC-HDU265
DP-1111	77305			HDU-265Y	39	77309	BC-HDU265
DP-1112	77305			HDU-265Y	39	77309	BC-HDU265
NB-2000	4109300			L-BQ1U	52		
NB-2050	4109300			L-BQ1U	52		
LG2125 LD	Y5555332			DP2-457U(TAY)	-		BC-DP57
LG2125 LE	Y5555332			DP2-457U(TAY)	-		BC-DP57
LG2125 LW	Y5009300			DP2-57(2LPY)	41		BC-DP57

BAOMA 宝马

MODEL 缝纫机机种	PART NO. 型号	WITH BC/CAP 配 BC/CP	EX. ITEM 专卖品	HIROSE HOOK 广濑梭头		BOBBIN CASE 梭芯套	
				ITEM 品名	PAGE 页	PART NO. 型号	ITEM 品名
GC0318-1				HSH-7.94DRN	—		BC-DLN
GC0378-1				HSH-32	52		
GC128-M				HSH-7.94B	31		BC-DB1
GC158-B				HSH-7.94AO	31		BC-DB1
GC158-BD				HSH-7.94AOTR	31		BC-DB1-NBL6
GC158-M				HSH-7.94B	31		BC-DB1
GC158-MD				HSH-7.94BTR	32		BC-DB1-NBL6
GC2018				HSH-31(12)	43		
GC20508-C				HSH-12-15MM	49		
GC20508-M				HSH-12-15M	46		
GC20538-C				HSH-12MC	50		CP-12MC
GC20538-M				HSH-12C	46		CP-12C
GC20608-1				HSH-12-15MM(V)	49		
GC20608-2				HSH-12-15MM(V)	49		
GC2318				HSH-31(12)	43		
GC2638-1				HYM-1341AY	48		CP-HPF545
GC2638-2				HSH-31(B)	43		
HG128				HSH-7.94BOH	32		BC-DB1
HG128-B				HSH-7.94AO	31		BC-DB1
HG128-M				HSH-7.94B	31		BC-DB1

BUTTERFLY 蝴蝶

MODEL	PART NO.	WITH BC/CAP	EX. ITEM	HIROSE HOOK		BOBBIN CASE	
				ITEM	PAGE	PART NO.	ITEM
GC25-1				HSH-7.94B	31		BC-DB1
GC25-2				HSH-7.94B	31		BC-DB1
GC2601				HSH-7.94B	31		BC-DB1
GC57-1				DB1-Z16	38		BC-DBZ(1)
GG2-1				DB1-Z16	38		BC-DBZ(1)
GG305-1				HSH-7.94ATR(MTQ)	40		BC-DBZ(3)-NBL6
GG3-1				DP2-57(2)	41		BC-DP57
GY4-1				DP2-NJ771	42		BC-LBH771

CHURCHILL 求精

MODEL 缝纫机机种	PART NO. 型号	WITH BC/CAP 配 BC/CP	EX. ITEM 专卖品	HIROSE HOOK 广濑梭头		BOBBIN CASE 梭芯套	
				ITEM 品名	PAGE 页	PART NO. 型号	ITEM 品名
QJ2230B				HSH-12-15MM	49		
QJ2230M				HSH-12-15M	46		
QJ2250				HSH-12C	46		CP-12C
QJ2250B				HSH-12MC	50		CP-12MC
QJ5200				HSH-7.94B	31		BC-DB1
QJ5550				HSH-7.94B	31		BC-DB1
QJ842-3				HG12-15L	45		
QJ842-5				HG12-15L(H)	45		
QJ845				HG12-15LC	45		CP-G12C
QJ8700				HSH-7.94B	31		BC-DB1
QJ872				HG12M(BR)	49		
QJ875				HG12MC(1)	49		CP-G12MC(1)
QJ8900				HSH-7.94B	31		BC-DB1

DADILI 大地利

MODEL	PART NO.	WITH BC/CAP	EX. ITEM	HIROSE HOOK		BOBBIN CASE	
				ITEM	PAGE	PART NO.	ITEM
DB2-B111-3				HSH-7.94B	31		BC-DB1
DB2-B111-5				HSH-7.94AO	31		BC-DB1
LT2-B842-3				HG12-15L	45		
LT2-B842-5				HG12-15L(H)	45		
LT2-B845-3				HG12-15LC	45		CP-G12C
LT2-B845-5				HG12-15LC	45		CP-G12C
LT2-B872-3				HG12M(BR)	49		
LT2-B872-5				HG12M(BR)	49		
LT2-B875-3				HG12MC(1)	49		CP-G12MC(1)
LT2-B875-5				HG12MC(1)	49		CP-G12MC(1)

DALIAN 大连

MODEL	PART NO.	WITH BC/CAP	EX. ITEM	HIROSE HOOK		BOBBIN CASE	
				ITEM	PAGE	PART NO.	ITEM
G18				DP2-NJ771	42		BC-LBH771

FEIQUI 飞球

MODEL	PART NO.	WITH BC/CAP	EX. ITEM	HIROSE HOOK		BOBBIN CASE	
				ITEM	PAGE	PART NO.	ITEM
GC158-1				HSH-7.94B	31		BC-DB1
GC1-6				HSH-7.94B	31		BC-DB1
GC668-1				HSH-7.94B	31		BC-DB1
GC668-28				HSH-7.94BOH	32		BC-DB1
GC668-5				HSH-7.94BOH	32		BC-DB1
GCL-5550N				HSH-7.94B	31		BC-DB1

FEIYUE 飞跃

MODEL 缝纫机机种	PART NO. 型号	WITH BC/CAP 配 BC/CP	EX. ITEM 专卖品	HIROSE HOOK 广濑梭头		BOBBIN CASE 梭芯套	
				ITEM 品名	PAGE 页	PART NO. 型号	ITEM 品名
GC1-5				DA1-B	38		BC-DB1
GC15-1				HSH-7.94B	31		BC-DB1
GC15-2				HSH-7.94B	31		BC-DB1
GC15-3				HSH-7.94BOH	32		BC-DB1
GC15-4				HSH-7.94B	31		BC-DB1
GC1-6				DA1-B	38		BC-DB1
GC28-1				HSH-7.94BOH	32		BC-DB1
GC28-3				HSH-7.94BOH	32		BC-DB1
GC290				HSH-7.94B	31		BC-DB1
GC5530				HSH-7.94B	31		BC-DB1
GC5550				HSH-7.94B	31		BC-DB1
GG28-1				DB1-Z16	38		BC-DBZ(1)
GG28-2				DB1-Z16	38		BC-DBZ(1)
GG28-3				DB1-Z16	38		BC-DBZ(1)
GG29-1				DB1-Z16	38		BC-DBZ(1)
GG30				DB1-Z16	38		BC-DBZ(1)

FLYINGMAN 飞人

MODEL	PART NO.	WITH BC/CAP	EX. ITEM	HIROSE HOOK		BOBBIN CASE	
				ITEM	PAGE	PART NO.	ITEM
GC20502-4				HSH-12-15M	46		
GC20601				HSM-A	35		BC-DBM(1)
GC51-1				HSH-7.94B	31		BC-DB1
GC9002				HSH-7.94B	31		BC-DB1
GC9002H				HSH-7.94AO	31		BC-DB1
GG0802				DB1-Z16	38		BC-DBZ(1)
GG302				DP2-57(2)	41		BC-DP57

FOMAX

MODEL	PART NO.	WITH BC/CAP	EX. ITEM	HIROSE HOOK		BOBBIN CASE	
				ITEM	PAGE	PART NO.	ITEM
KDD-5570				HSH-7.94B	31		BC-DB1
KDD-5570-7				HSH-7.94BTR	32		BC-DB1-NBL6
KDD-5570H				HSH-7.94BOH	32		BC-DB1
KDD-5570H-7				HSH-7.94BOHN	32		BC-DB1-NBL6
KDD-5570HB				HSM-A	35		BC-DBM(1)

GEMSY 宝石

MODEL 缝纫机机种	PART NO. 型号	WITH BC/CAP 配 BC/CP	EX. ITEM 专卖品	HIROSE HOOK 广濑梭头		BOBBIN CASE 梭芯套	
				ITEM 品名	PAGE 页	PART NO. 型号	ITEM 品名
736				HSH-7.94B	31		BC-DB1
842				HG12-15L(TR1)	45		
845				HG12-15LC	45		CP-G12C
872				HG12M(BR)	49		
875				HG12MC(1)	49		CP-G12MC(1)
2284				DP2-57(3LP2R)	41		UNAVAILABLE
5550				HSH-7.94B	31		BC-DB1
7070				HSH-7.94B	31		BC-DB1
7080				HSH-7.94B	31		BC-DB1
8500				HSH-7.94B	31		BC-DB1
8700				HSH-7.94B	31		BC-DB1
8900				HSH-7.94B	31		BC-DB1
7-18				HSH-7.94B	31		BC-DB1
7-28				HSH-7.94B	31		BC-DB1
2284-7				DP2-57(3LP2R)	41		UNAVAILABLE
8900-7				HSH-7.94BTR	32		BC-DB1-NBL6
2000-1M				HSH-12-15M	46		
2000-2B				HSH-12MC	50		CP-12MC
2000-2M				HSH-12C	46		CP-12C
2001-1B				HSH-12-15MM	49		
5590H				HSH-7.94AO	31		BC-DB1
7-18A				HSM-A	35		BC-DBM(1)
7-28H				HSH-7.94AO	31		BC-DB1
8700H				HSH-7.94AO	31		BC-DB1
872-7				HG12MC(1)TR	49		CP-G12M(BR)TR
875-7				HG12MC(1)TR	49		CP-G12MC(1)TR
8900H				HSH-7.94AO	31		BC-DB1
8900H-7				HSH-7.94BTR(10SPH)	-		BC-DB1-NBL6
9000W-7				HSH-7.94BTR(RPW)	33		BC-DB1-NBL6
GEM5550				HSH-7.94B	31		BC-DB1
GEMS				HSH-7.94B	31		BC-DB1

HIGHLEAD 海菱

MODEL 缝纫机机种	PART NO. 型号	WITH BC/CAP 配 BC/CP	EX. ITEM 专卖品	HIROSE HOOK 广濑梭头		BOBBIN CASE 梭芯套	
				ITEM 品名	PAGE 页	PART NO. 型号	ITEM 品名
GC0318-1				HSM-A	35		BC-DBM(1)
GC0318-8				HSM-A	35		BC-DBM(1)
GC0388				HSM-A	35		BC-DBM(1)
GC0388-D				HSM-A1HTR	35		BC-DBM(1)-NBL
GC0518				HSH-7.94DRN	-		BC-DLN
GC0618				HSH-7.94BRNH	32		BC-DLN
GC0618-1				HSH-7.94BRNH	32		BC-DLN
GC128-B				HSM-A	35		BC-DBM(1)
GC128-B-D3				HSM-A1HTR	35		BC-DBM(1)-NBL
GC128-H				HSH-7.94A	31		BC-DB1
GC128-M				HSH-7.94B	31		BC-DB1
GC128-M-D3				HSH-7.94BTR(3)	33		BC-DB1-NBL6
GC188-B				HSM-A	35		BC-DBM(1)
GC188-H				HSH-7.94AO	31		BC-DB1
GC188-M				HSH-7.94B	31		BC-DB1
GC188-MC				HSH-7.94B	31		BC-DB1
GC20518-B				HSH-12MC	50		CP-12MC
GC20518-M				HSH-12-15M	46		
GC20518-M				HSH-12-15M	46		
GC20528-B				HSH-12-15MM	49		
GC20528-B-D				HSH-12MC(3)	50		CP-12MC(3)
GC20528-M				HSH-12C	46		CP-12C
GC20618-1				HSH-12-15MM(V)	49		
GC20618-1D				HSH-12-15MM(410)	49		
GC20618-2				HSH-12-15MM(V)	49		
GC24018				HSH-31(6)	43		
GC24018-1				HSH-31(6)	43		
GC24518-1				HSH-31(6)	43		
GC24518-2				HSH-31(6)	43		
GC24618				HPF-490(A)	43		CP-HPF151
GC24618-1				HPF-490(A)	43		CP-HPF151
GC6-28				HSH-7.94B	31		BC-DB1

HUANAN 华南

MODEL 缝纫机机种	PART NO. 型号	WITH BC/CAP 配 BC/CP	EX. ITEM 专卖品	HIROSE HOOK 广濑梭头		BOBBIN CASE 梭芯套	
				ITEM 品名	PAGE 页	PART NO. 型号	ITEM 品名
G16-1				DP2-NJ	42		BC-DP2(2)
GC0301-1				HSH-7.94DRN	—		BC-DLN
GC10-1				HSH-7.94B	31		BC-DB1
GC10-1B				HSH-7.94B	31		BC-DB1
GC10-1H				HSH-7.94A	31		BC-DB1
GC10-1P				HSH-7.94A	31		BC-DB1
GC10-1S				HSH-7.94B	31		BC-DB1
GC20505-1				HG12L(1)	45		CP-G12L(1)
GC20505-1				HG12L(1)	45		CP-G12L(1)
GC24010-1				HSH-31(12)	43		
GC24011-1				HSH-31(12)	43		
GC24301-2				HPF-490(A)	43		CP-HPF151
GC281				HSH-7.94B	31		BC-DB1
GC28-1				HSH-7.94B	31		BC-DB1
GC281B				HSH-7.94B	31		BC-DB1
GC281H				HSH-7.94B	31		BC-DB1
GC281P				HSH-7.94B	31		BC-DB1
GC281S				HSH-7.94B	31		BC-DB1
GC28-3				HSH-7.94B	31		BC-DB1
GC28-3B				HSH-7.94B	31		BC-DB1
GC28-3H				HSH-7.94B	31		BC-DB1
GC28-3P				HSH-7.94B	31		BC-DB1
GC28-3S				HSH-7.94B	31		BC-DB1
GC48-1				HSH-7.94B	31		BC-DB1

JACK 杰克

MODEL	PART NO.	WITH BC/CAP	EX. ITEM	HIROSE HOOK		BOBBIN CASE	
				ITEM	PAGE	PART NO.	ITEM
JK457				DP2-457U(T)	41		BC-DP57
JK781				DP2-NJ771	42		BC-LBH771
JK5842-3				HG12-15L	45		
JK6318				HSM-A	35		BC-DBM(1)
JK8500				HSH-7.94B	31		BC-DB1
JK8500H				HSH-7.94BOH	32		BC-DB1
JK5845-3				HG12-15LC	45		CP-G12C
JK5845-5				HG12-15LCTR1	45		CP-G12CTR(1)
JK5872-3				HG12M(BR)	49		
JK5872-5				HG12MC(1)TR	49		CP-G12M(BR)TR
JK5875-3				HG12MC(1)	49		CP-G12MC(1)
JK5875-5				HG12MC(1)TR	49		CP-G12M(BR)TR
JK8900D				HSH-7.94BTR	32		BC-DB1-NBL6
JK5842-5				HSH-12-15L(TR1)	46		
JK5842D-3				HSH-12-15L(TR1)	46		

JINSHI 金狮

MODEL 缝纫机机种	PART NO. 型号	WITH BC/CAP 配 BC/CP	EX. ITEM 专卖品	HIROSE HOOK 广濑梭头		BOBBIN CASE 梭芯套	
				ITEM 品名	PAGE 页	PART NO. 型号	ITEM 品名
212-18				HSM-A	35		BC-DBM(1)
212-3				HSH-7.94B	31		BC-DB1
212-3B				HSH-7.94BOH	32		BC-DB1
212-5H				HSH-12-15M	46		
212-8				HSH-7.94B	31		BC-DB1
212-8B				HSH-7.94BOH	32		BC-DB1
212-9				HSH-7.94B	31		BC-DB1

MEIJA 美佳

MODEL	PART NO.	WITH BC/CAP	EX. ITEM	HIROSE HOOK		BOBBIN CASE	
				ITEM	PAGE	PART NO.	ITEM
G15-2				DB1-Z16	38		BC-DBZ(1)
GG70701				HSH-7.94A(MTQ)	39		BC-DBZ(3)NBL6

PEMAL 良机

MODEL	PART NO.	WITH BC/CAP	EX. ITEM	HIROSE HOOK		BOBBIN CASE	
				ITEM	PAGE	PART NO.	ITEM
CDL-1388N				HSH-7.94A	31		BC-DB1
CDL-5550N				HSH-7.94B	31		BC-DB1
LT2-B842-3				HSH-12-15M	46		
LT2-B845-3				HSH-12-15MM	49		
LT2-B872				HSH-12-15M	46		
LT2-B875				HSH-12-15MM	49		
PM-780				DP2-NJ	42		BC-DP2(2)

PROTEX 通字

MODEL 缝纫机机种	PART NO. 型号	WITH BC/CAP 配 BC/CP	EX. ITEM 专卖品	HIROSE HOOK 广濑梭头		BOBBIN CASE 梭芯套	
				ITEM 品名	PAGE 页	PART NO. 型号	ITEM 品名
GC39-1				HSH-7.94B	31		BC-DB1
GC5550				HSH-7.94B	31		BC-DB1
GC628				HSH-7.94B	31		BC-DB1
GG20U				DB1-BZ(20)	38		BC-DBZ(3)
TY1130H				HSH-7.94BOH	32		BC-DB1
TY1130M				HSH-7.94B	31		BC-DB1
TY2000				HSH-7.94B	31		BC-DB1
TY2000-5				HSH-7.94BOH	32		BC-DB1
TY2000-6				HSH-7.94BOH	32		BC-DB1
TY6180H				HSH-7.94BOH	32		BC-DB1
TY6180M				HSH-7.94B	31		BC-DB1
TY8500				HSH-7.94B	31		BC-DB1
TY-B211-413				HSH-7.94BTR	32		BC-DB1-NBL6
TY-B211-415				HSH-7.94BOHNTR	32		BC-DB1-NBL6
TY-B721-3				HSH-7.94BRN	32		BC-DB1
TY-B721-5				HSH-7.94BRNH	32		BC-DB1
TY-B842-3				HG12-15L	45		
TY-B842-5				HG12-15L(H)	45		
TY-B845-403				HG12-15LCTR1	45		CP-G12CTR(1)
TY-B872-5				HG12M(BR)	49		
TY-B875-5				HG12MC(1)	49		CP-G12MC(1)

SANGOOD 双角

MODEL	PART NO.	WITH BC/CAP	EX. ITEM	HIROSE HOOK		BOBBIN CASE	
				ITEM	PAGE	PART NO.	ITEM
GC31				HSH-7.94B	31		BC-DB1
GC32				HSH-7.94BTR	32		BC-DB1-NBL6
GC33				HSH-7.94B	31		BC-DB1
GC34				HSH-7.94B	31		BC-DB1
GC40-1				HSH-7.94B	31		BC-DB1
GF11001				DP2-NJ	42		BC-DP2(2)

SHANGGONG 上工

MODEL 缝纫机机种	PART NO. 型号	WITH BC/CAP 配 BC/CP	EX. ITEM 专卖品	HIROSE HOOK 广濑梭头		BOBBIN CASE 梭芯套	
				ITEM 品名	PAGE 页	PART NO. 型号	ITEM 品名
8800				HSH-7.94B	31		BC-DB1
G15				DP2-NJ	42		BC-DP2(2)
GC0301				HSH-7.94DRN	—		BC-DLN-NBL
GC0601-1				HSH-7.94DRN	—		BC-DLN-NBL
GC1-3				HSH-7.94B	31		BC-DB1
GC15-1				HSH-7.94B	31		BC-DB1
GC15-2				HSH-7.94B	31		BC-DB1
GC15-3				HSH-7.94BOH	32		BC-DB1
GC15-4				HSH-7.94BOH	32		BC-DB1
GC15-5-4D				HSH-21-40(J)	47		
GC22				HSH-7.94B	31		BC-DB1
GC30-1				HSH-7.94B	31		BC-DB1
GC30-2				HSH-7.94B	31		BC-DB1
GC30-3				HSH-7.94B	31		BC-DB1
GC-30-4-5D				HSH-7.94BTR	32		BC-DB1-NBL6
GC45-1				HSH-7.94B	31		BC-DB1
GC505-1				HSH-7.94DRN	—		BC-DLN-NBL
GC5550				HSH-7.94B	31		BC-DB1
GC555-4-5D				HSH-7.94BTR	32		BC-DB1-NBL6
GC8-2				HSH-7.94B	31		BC-DB1
GD8-1				HSH-12M-82CTR(L)	50		CP-M82C
GD8-1				HSH-12M-82CTR(R)	50		CP-M82C
GD8-4				HSH-12M-82CTR(L)	50		CP-M82C
GD8-4				HSH-12M-82CTR(R)	50		CP-M82C
GD8-7				HSH-12M-82CTR(L)	50		CP-M82C
GD8-7				HSH-12M-82CTR(R)	50		CP-M82C
GD9				HSH-21-40(J)	47		
GDB				HSH-21-40(J)	47		
GF108				DP2-NJ771	42		BC-LBH771

SHEEN 盛铭

MODEL	PART NO.	WITH BC/CAP	EX. ITEM	HIROSE HOOK		BOBBIN CASE	
				ITEM	PAGE	PART NO.	ITEM
GG758-615				HSH-7.94AO	31		BC-DBZ(3)NBL6
GG758-920				HSH-7.94ATR(MTQ)	40		BC-DBZ(3)NBL6

TYPICAL 标准

MODEL 缝纫机机种	PART NO. 型号	WITH BC/CAP 配 BC/CP	EX. ITEM 专卖品	HIROSE HOOK 广濑梭头		BOBBIN CASE 梭芯套	
				ITEM 品名	PAGE 页	PART NO. 型号	ITEM 品名
GC20201				HSH-12-15M	46		
GC20202				HSH-12-15MM	49		
GC6-1				HSH-7.94B	31		BC-DB1
GC6100HD				HSH-7.94BOH(1)	32		BC-DB1
GC6160H				HSH-7.94BOHNTR(B)	32		BC-DB1-NBL6
GC6160MD3				HSH-7.94BTR(210)	-		BC-DLN
GC6-1-D3				HSH-7.94BTR(3)	33		BC-DB1-NBL6
GC6220BD				HSH-12-15MM(3)TR	49		
GC6220MD				HSH-12-15MTR(3)	46		
GC6240B				HSH-12MC	50		CP-12MC
GC6240M				HSH-12C	46		CP-12C
GC6240MD				HSH-12-15M(3)	46		CP-12C
GC6-28				HSH-7.94B	31		BC-DB1
GC6-8				HSH-7.94AO	31		BC-DB1
GC6842H				HG12-15L(H)	45		
GC6842HD3				HG12L(1)TR1	45		CP-G12L(1)
GC6842M				HG12-15L	45		
GC6842MD3				HG12L(1)TR1	45		CP-G12L(1)
GC6845H				HG12-15LC	45		CP-G12C
GC6845HD3				HG12-15LCTR1	45		CP-G12CTR(1)
GC6845MD3				HG12-15LCTR1	45		CP-G12CTR(1)
GC6872H				HG12M(BR)	49		
GC6872M				HG12M(BR)	49		
GC6872MD3				HG12MC(1)TR	49		CP-G12MC(1)TR
GC6875H				HG12MC(1)	49		CP-G12MC(1)
GC6875HD3				HG12MC(1)TR	49		CP-G12MC(1)TR
GC6875M				HG12MC(1)	49		CP-G12MC(1)
GC6875MD3				HG12MC(1)TR	49		CP-G12MC(1)TR
GC6-8-D2				HSH-7.94BOHNTR	32		BC-DB1-NBL6
GC69-1				HSH-7.94B	31		BC-DB1
GC6-9-D2				HSM-A1HTR	35		BC-DBM(1)-NBL
GG1-1				DB1-Z16	38		BC-DBZ(3)
GG1-2				DB1-Z16	38		BC-DBZ(3)
GYD12-6				HSH-7.94A(MTQ)	39		BC-DBZ(3)NBL6
GYD20-6				HSH-7.94A(MTQ)	39		BC-DBZ(3)NBL6
GYD7-6				HSH-7.94A(MTQ)	39		BC-DBZ(3)NBL6

TYPICAL BROTHER 兄弟标准

MODEL	PART NO.	WITH BC/CAP	EX. ITEM	HIROSE HOOK		BOBBIN CASE	
				ITEM	PAGE	PART NO.	ITEM
DB2-C101-3				HSH-7.94B(RT)	32		BC-DB1-NBL6
DB2-C101-5				HSH-7.94BOH(1)	32		BC-DB1-NBL6
DB2-C101-6				HSH-7.94A	31		BC-DB1-NBL6
DB2-C101-7				HSH-7.94A	31		BC-DB1-NBL6
DB2-C201-1				HSH-7.94BTR(737SPQ)	33		BC-DB1-NBL6
DB2-C201-3				HSH-7.94BTR(737)	33		BC-DB1-NBL6
DB2-C201-5				HSH-7.94BOHNTR(B)	32		BC-DB1-NBL6

WANPING 苑坪

MODEL 缝纫机机种	PART NO. 型号	WITH BC/CAP 配BC/CP	EX. ITEM 专卖品	HIROSE HOOK 广濑梭头		BOBBIN CASE 梭芯套	
				ITEM 品名	PAGE 页	PART NO. 型号	ITEM 品名
842				HG12-15L(TR1)	45		
845				HG12-15LCTR1	45		CP-G12CTR(1)
872				HG12MC(1)TR	49		CP-G12M(BR)TR
875				HG12MC(1)TR	49		CP-G12MC(1)TR
1245				HPF-1242(A)	48		CP-HPF545
733R				HSH-7-3	51		
B727				HSM-B1H	36		BC-DBM(1)
GC0302				HSM-B1H	36		BC-DBM(1)
GC0302-D2				HSM-B1HTR	36		BC-DBM(1)-NBL1
GC203				HSH-7.94AO	31		BC-DB1
GC203				HSH-7.94B	31		BC-DB1
GC20606				HSH-12-15MM(V)	49		
GC24016				HSH-31(12)	43		
GC24660				HPF-490(A)	43		CP-HPF151
GC24680				HPF-490(A)	43		CP-HPF151
GC6-5				HSM-A1	35		BC-DBM(1)-NBL
GC6-6				HSM-A1	35		BC-DBM(1)-NBL
GC6-7				HSM-A1	35		BC-DBM(1)-NBL
GN2301				HSM-A1HTR	35		BC-DBM(1)-NBL
GN2603				HSM-A1HTR	35		BC-DBM(1)-NBL
PWB-8GW				HPF-490(A)	43		CP-HPF151
SK-2B				HSH-32	52		
TW2-B842-3				HG12-15L	45		
TW2-B845-5				HG12-15LC	45		CP-G12C
TW2-B872				HG12M(BR)	49		
TW2-B875				HG12MC(1)	49		CP-G12MC(1)
TW3-243				HAD-204(273)	51		
TW3-335V				HPF-335(5)	39		BC-PF9076
TW3-341				HYM-1341AY	48		CP-HPF545
TW3-441				HAD-204(273)	51		
TW3-471				HAD-204(273)	51		
TW3-8B				HSH-31(B)	43		
TW3-P335				HPF-335	39		BC-PF9076
TW5-810				HSH-31(12)	43		
TWB-22GW				HPF-490(A)	43		CP-HPF151

ZGM 珠光

MODEL	PART NO.	WITH BC/CAP	EX. ITEM	HIROSE HOOK		BOBBIN CASE	
				ITEM	PAGE	PART NO.	ITEM
GG798-1				HSH-7.94ATR(MTQ)	40		BC-DBZ(3)NBL6
GG798-2				HSH-7.94AOTR	31		BC-DBZ(3)NBL6
GG798-3				HSH-7.94AO	31		BC-DBZ(3)NBL6

ZOJE 中捷

MODEL 缝纫机机种	PART NO. 型号	WITH BC/CAP 配 BC/CP	EX. ITEM 专卖品	HIROSE HOOK 广濑梭头		BOBBIN CASE 梭芯套	
				ITEM 品名	PAGE 页	PART NO. 型号	ITEM 品名
845				HG12-15LC	45		CP-G12C
872				HG12M(BR)	49		
875				HG12MC(1)	49		CP-G12MC(1)
842-5				HG12-15L(H)	45		
842-D3				HG12-15L(TR1)	45		
845-D3				HG12-15LCTR1	45		CP-G12CTR(1)
872-D3				HG12MC(1)TR	49		CP-G12M(BR)TR
875-D3				HG12MC(1)TR	49		CP-G12MC(1)TR
GC15-1				HSH-7.94B	31		BC-DB1
GC5580				HSH-7.94B	31		BC-DB1
GC5580-5				HSH-7.94BOH	32		BC-DB1
GC80-1				HSH-7.94B	31		BC-DB1
GC80-5				HSH-7.94BOH	32		BC-DB1
GC90-1				HSH-7.94B	31		BC-DB1
GC90-5				HSH-7.94BOH	32		BC-DB1
GCZ201-1				HSH-7.94B	31		BC-DB1
GG457				DP2-457U(T)	41		BC-DP57
ZJ457A135				DP2-457U(T)	41		BC-DP57
ZJ457A143				DP2-457U(T)	41		BC-DP57
ZJ8500-D3				HSH-7.94BTR	32		BC-DB1-NBL6
ZJ15-1				HSH-7.94B	31		BC-DB1
ZJ457A125/105				DP2-457U(T)	41		BC-DP57
ZJ5550				HSH-7.94B	31		BC-DB1
ZJ5580				HSH-7.94B	31		BC-DB1
ZJ5580-D3				HSH-7.94BTR	32		BC-DB1-NBL6
ZJ5580-5-D3				HSH-7.94BTR	32		BC-DB1-NBL6
ZJ5600N				HSH-7.94BOH	32		BC-DB1
ZJ5580-5				HSH-7.94BOH	32		BC-DB1
ZJ842				HG12-15L	45		
ZJ8500-5				HSH-7.94BOH	32		BC-DB1
ZJ8500N				HSH-7.94B	31		BC-DB1
ZJ8850-5-D3				HSH-7.94BTR	32		BC-DB1-NBL6
ZJ90-1				HSH-7.94B	31		BC-DB1
ZJ80-1				HSH-7.94B	31		BC-DB1
ZJ999				HSH-7.94B	31		BC-DB1

SUNSTAR

MODEL 缝纫机机种	PART NO. 型号	WITH BC/CAP 配 BC/CP	EX. ITEM 专用品	HIROSE HOOK 广濑梭头		BOBBIN CASE 梭芯套	
				ITEM 品名	PAGE 页	PART NO. 型号	ITEM 品名
BH/3000				DP2-800FR	41		BC-DP800
DPK-2				DP2	41		BC-DP2(2)
KLZ-371				DB1-Z16	38		BC-DBZ(1)
KM-1060BL				HAD-467TR(1B)	52		
KM-1060BL-7			※	HAD-467CTR(SU)	52		CP-HAD467TR
KM-123A				HSH-7.94B	31		BC-DB1
KM-123B				HSH-7.94BOH	32		BC-DB1
KM-146BL				HSM-B(1SU)	36		BC-DBM(1)
KM-2070				DP2-855	42		BC-DP855
KM-2077				DP2-856TR	42		BC-DP856
KM-235A				HSH-7.94BTR	32		BC-DB1-NBL6
KM-235B				HSH-7.94BOHNTR	32		BC-DLN-NBL
KM-250AU				HSH-7.94BTR(P)	—		BC-DB1-NBL6
KM-350A				HSH-7.94BSN	32		BC-DLN
KM-350A-7				HSH-7.94BTR(N)	33		BC-DLN(NBL)
KM-350B				HSH-7.94BOHN(1)	32		BC-DB1
KM-380				DA1-BTR	38		BC-NJ(380)
KM-380BL				HSM-B(SU)	36		BC-DBM(1)
KM-390BL				HSH-31MMB(5)	48		
KM-560				HSH-12-15MM(5)	49		
KM-560-7				HSH-12-15MMB(5)TR4	49		
KM-590BL				HSM-A1TR(280)	35		BC-NJ280L-NBL3
KM-640BL				HSM-A(3)	35		BC-DBM(1)
KM-640BL-7				HSM-A1HTR	35		BC-DBM(1)-NBL
KM-740				HSH-12-15L	46		
KM-740BL				HSH-12-15MM	49		
KM-750				HR12-15L	45		
KM-750-7				HR12-15L(TR1)	45		
KM-750BL				HR12M(BR)	49		
KM-790				HR12-15LC	45		CP-G12C(2)
KM-790-7				HR12-15LCTR1	45		CP-G12C(2)
KM-790BL				HR12MC(1)	49		CP-G12MC(1)TR
KM-790BL-7				HR12MC(1)TR	49		CP-G12MC(1)TR
KM-867				HSH-31(12)	43		
KM-867-7				HPF-490A(5)TR	43		CP-HPF144TR
KM-957				HPF-490(A)	43		CP-HPF151
SPS/A-1306(GP)				TC-PSR(SUA)	—		BC-TCLK(B)
SPS/A-1306(GS)				TC-LK(SUA)	51		BC-TCLK(B)
SPS/A-1306(HP)				TC-PSR(SUB)	—		BC-TCLK(B)
SPS/A-1306(HS)				TC-LK(SUB)	51		BC-TCLK(B)
SPS/C-5050				HSM-A1HMTR	35		BC-DBM(1)-NBL

SWF

MODEL 縫紉機機種	PART NO. 型号	WITH BC/CAP 配 BC/CP	EX. ITEM 专卖品	HIROSE HOOK 广濑梭头		BOBBIN CASE 梭芯套	
				ITEM 品名	PAGE 页	PART NO. 型号	ITEM 品名
SWF/B-T1201			※	HSH-7.94ATR(MQSU)	40		BC-DBZ(3)NBL6
SWF/B-T1201C			※	HSH-7.94ATR(MQSUL)	40		BC-DBZ(3)NBL6
SWF/B-UI1212-45			※	HSH-7.94ATR(MQSUNL)	40		BC-DBZ(3)NBL6
SWF/B-UK1202-45			※	HTH-ATR(MQESU)	40		BC-HTH(ZEH)
SWF/B-UK1204-45			※	HTH-ATR(MQESUL)	40		BC-HTH(ZEH)
SWF/B-UK1206-45			※	HTH-ATR(MQESUNL)	40		BC-HTH(ZEH)
SWF/C-WD920-55							
SWF/C-WE1204-55/75							
SWF/C-WE1206-75							
SWF/H-WD920-55							

UNICORN

MODEL	PART NO.	WITH BC/CAP	EX. ITEM	HIROSE HOOK		BOBBIN CASE	
				ITEM	PAGE	PART NO.	ITEM
TZ1-B652				DB1-Z16B	38		BC-DBZ(1)
TZ1-B652XH				HTD-Z16B(E)	—		BC-HTH(ZEH)
LZ2-H272				DB1-Z16	38		BC-DBZ(1)
DB2-H310/H510/H515				HSH-7.94B	31		BC-DB1
DB2-H311/H510H/H515H				HSH-7.94A(3)	31		BC-DB1
LS2-H5100(M)/H5150M				HSH-7.94BTR	32		BC-DB1-NBL6
LS2-H5200/H5300				HSH-7.94BTR	32		BC-DB1-NBL6
LS2-H5100(H)/H5150H				HSH-7.94BOHNTR	32		BC-DB1-NBL6
LS2-H530				HSH-7.94B(RT)	32		BC-DB1
LS2-H520				HSH-7.94DRN	—		BC-DB1
DB2-H312/H510XH/H515XH				HSM-A(3)	35		BC-DBM(1)
LS2-H540/H5400/H5100XH				HSM-A1HTR	35		BC-DBM(1)-NBL
LS2-H5150XH/H5110XH				HSM-A1HTR	35		BC-DBM(1)-NBL
UAS-H1407(H)				TC-LK(BUC)	51		BC-TCLK(B)
UAS-H1407(M)				TC-LK(A)	—		BC-TCLK(B)
DB2-H320/321 LS2-H620(M)				HSH-12-15M	46		
DB2-H322/323 LS2-H620(H)				HSH-12-15MM	49		
LT2-H625(M)				HSH-12C	46		CP-12C
LT2-H625(H)				HSH-12MC	50		CP-12MC
PLN-7B/27B LT5-H710/H720				HSH-31(B12)	43		
LT5-H7200/H7600				HPF-490(5)TR	43		CP-HPFF144TR
LT2-H6200(H)				HSH-12-15MM(3)TR	49		
LT2-H6200(M)				HSH-12-15MTR(3)	46		
LT2-H6250(H)				HSH-12MCA(3UC)	—		CP-G12MC(1)TR
LT2-H6250(M)				HSH-12-15M(3UC)	46		CP-G12C(2SU)

CHIKON 奇鋼

MODEL 縫紉機機種	PART NO. 型号	WITH BC/CAP 配 BC/CP	EX. ITEM 专卖品	HIROSE HOOK 广濑梭头		BOBBIN CASE 梭芯套	
				ITEM 品名	PAGE 页	PART NO. 型号	ITEM 品名
CK-1461				HAD-204	51		
CK-1508				HSH-12-15MMJ(A)	49		
CK-1560				HSH-12-15MMJ(A)	49		
CK-243				HAD-204(6)	51		
CK-273				HAD-204(6)	51		
CK-441				HAD-204(6)	51		
CK-461				HAD-204(6)	51		
CK-471				HAD-204(6)	51		
CK-563				HSH-12-15MMJ	49		
CK-767				HSH-7-3	51		
CK-8BL				HSM-A(6)	35		BC-DBM(2)-NBL2
CK-8BL-1				HSM-A(6)	35		BC-DBM(2)-NBL2
SD-767TR				HSH-7-3	51		
SLH-2B				HSH-7-3	51		
SLH-767R				HSH-7-3	51		
STH-8BL				HSM-A(6)	35		BC-DBM(2)-NBL2

CHUAN NENG 傅能

MODEL	PART NO.	WITH BC/CAP	EX. ITEM	HIROSE HOOK		BOBBIN CASE	
				ITEM	PAGE	PART NO.	ITEM
CN-915-3				HSM-B(Z17)	36		BC-DBM(Z1)
CN-915-5				HSM-B(Z17)	36		BC-DBM(Z1)
CN-990-3				HSH-7.94B	31		BC-DB1
CN-990-5				HSH-7.94A	31		BC-DB1
CN-990-7				HSH-7.94A	31		BC-DB1
CN-991-3				HSH-7.94ATR	31		BC-DB1-NBL6
CN-991-3				HSH-7.94BTR	32		BC-DB1-NBL6
CN-991-5				HSH-7.94ATR	31		BC-DB1-NBL6
CN-991-7				HSH-7.94ATR	31		BC-DB1-NBL6
CN-992-3				HSH-7.94BTR	32		BC-DB1-NBL6
CN-992-5				HSH-7.94ATR	31		BC-DB1-NBL6
CN-992-7				HSH-7.94ATR	31		BC-DB1-NBL6

FANG HUNG 方宏 (PLATINA)

MODEL	PART NO.	WITH BC/CAP	EX. ITEM	HIROSE HOOK		BOBBIN CASE	
				ITEM	PAGE	PART NO.	ITEM
TJ-3300				HSM-A	35		BC-DBM(1)
TJ-335				DB1-Z16B	38		BC-DBZ(2)
TJ-335H-BH				DB1-Z16B	38		BC-DBZ(2)
TJ-457				DP2-57(2LP)	41		BC-DP57
TJ-457A				DP2-457U(T)	41		BC-DP57
TJ-652				DB1-Z16B	38		BC-DBZ(2)
TJ-842				HSH-12-15L	46		
TJ-845				HSH-12-15LC	46		CP-12C
TJ-8700				HSH-7.94B	31		BC-DB1
TJ-8700-7				HSH-7.94BTR	32		BC-DB1-NBL6

FENG YING 鋒穎

MODEL 缝纫机机种	PART NO. 型号	WITH BC/CAP 配 BC/CP	EX. ITEM 专卖品	HIROSE HOOK 广濑梭头		BOBBIN CASE 梭芯套	
				ITEM 品名	PAGE 页	PART NO. 型号	ITEM 品名
FY-241				HSM-A1TR(280)	35		BC-DBM(2)-NBL
FY-341				HYM-1341AY	48		CP-HPF545
FY-810				HSH-31(12)	43		
FY-820				HSH-31(12)	43		

GOLDEN WHEEL 金輪

MODEL 縫紉機機種	PART NO. 型号	WITH BC/CAP 配BC/CP	EX. ITEM 专卖品	HIROSE HOOK 广濑梭头		BOBBIN CASE 梭芯套	
				ITEM 品名	PAGE 页	PART NO. 型号	ITEM 品名
CS-1100F				HSB-7.94B	31		BC-DB1
CS-1100H				HSB-7.94A	31		BC-DB1
CS-1100S				HSB-7.94A	31		BC-DB1
CS-2180				DB1-BZ(20)	38		BC-DBZ(1)
CS-2180				DB1-BZ(20)	38		BC-DBZ(1)
CS-2280				HPF-335(5)	39		BC-PF9076(14)
CS-3100-3				HSB-12-15L(H)	46		
CS-3100L				HSB-12-15MM	49		
CS-3150				HSB-12-15LC	46		CP-12C
CS-3150-3				HSB-12-15LC	46		CP-12C
CS-3150-5				HSB-12-15LC	46		CP-12C
CS-3150-L				HSB-12MC	50		CP-12MC
CS-335BH				DB1-Z16B	38		BC-DBZ(1)
CS-350				DA1-A	38		BC-DB1
CS-350L				HSM-A	35		BC-DBM(1)
CS-350L-T				HSM-A1HTR	35		BC-DBM(1)-NBL
CS-3600				DA1-B	38		BC-DB1
CS-3610				HSB-31(12)	43		
CS-3811				HSM-A	35		BC-DBM(1)-NBL
CS3L-7241				HSB-12-15MM(V)	49		
CS3L-7243				HSB-12-15MMJ(A)	49		
CS-5150				HSB-7.94B	31		BC-DB1
CS-5361N				HSB-31(6)	43		
CS-5362N				HSB-31(6)	43		
CS-6000				HSB-7.94A	31		BC-DB1
CS-6000BT				HSB-7.94CTR	34		BC-DB1-NBL6
CS-6100				HSM-A	35		BC-DBM(1)
CS-6103				HSM-A	35		BC-DBM(1)
CS-6104				HSM-A	35		BC-DBM(1)
CS-6111B				HPF-490A(5)TR	43		CP-HPF144TR
CS-6111BT				HPF-490A(5)TR	43		CP-HPF144TR
CS-6111T				HPF-490A(5)TR	43		CP-HPF144TR
CS-6112B				HPF-490A(5)TR	43		CP-HPF144TR
CS-6112BT				HPF-490A(5)TR	43		CP-HPF144TR
CS-6112T				HPF-490A(5)TR	43		CP-HPF144TR
CS-6120				HSM-A	35		BC-DBM(1)
CS-7162				HSB-12-15M	46		
CS-7162S				HSB-12-15M	46		
CS-7165				HSB-12C	46		CP-12C
CS-7165-BT				HSB-12-15M(3)	46		CP-12C
CS-7175				HSB-12MC	50		CP-12MC
CS-7175-BT				HSB-12MC(3)	50		CP-12MC(3)
CS-7175H-BT				HSB-12MC(3)	50		CP-12MC(3)
CS-7361N				HSB-31(6)	43		
CS-7362				HSB-31(6)	43		
CS-8000-20				DA1-B	38		BC-DB1
CS-8000-25				DA1-B	38		BC-DB1

GOLDEN WHEEL 金輪

MODEL 縫纫机机种	PART NO. 型号	WITH BC/CAP 配BC/CP	EX. ITEM 专卖品	HIROSE HOOK 广濑梭头		BOBBIN CASE 梭芯套	
				ITEM 品名	PAGE 页	PART NO. 型号	ITEM 品名
CS-8000-30				DA1-B	38		BC-DB1
CS-810				HSH-31(6)	43		
CS-820				HSH-31(6)	43		
CS-821				HSH-31(6)	43		
CS-822				HSH-31(6)	43		
CS-861				HPF-490(A)	43		CP-HPF151
CS-862				HPF-490(A)	43		CP-HPF151
CS-8703				DB1-Z16B	38		BC-DBZ(1)
CS-871L				HSH-12-15MM	49		
CS-872-3				HSH-12-15L(H)	46		
CS-872L				HSH-12-15MM	49		
CS-875-3				HSH-12-15LC	46		CP-12C
CS-875-5				HSH-12-15LC	46		CP-12C
CS-875L				HSH-12MC	50		CP-12MC
CS-8810				HPF-490(A)	43		CP-HPF151
CS-8820				HPF-490(A)	43		CP-HPF151
CS-8BH				HSH-31(12)	43		
CS-8BH				HSH-31(12)	43		
CSH-7800				DP2-NJ771	42		BC-LBH771
CSL-1720				HSH-12C	46		CP-12C
CSL-1800				HSH-32	52		
CSL-1801				HSH-32	52		
CSU-4101				HSH-12-15MM(V)	49		

JASON SEWING 貴峰

MODEL	PART NO.	WITH BC/CAP	EX. ITEM	HIROSE HOOK		BOBBIN CASE	
				ITEM	PAGE	PART NO.	ITEM
GF-204				HAD-204(6)	51		
GF-205				HAD-204(6)	51		
GF-205-335				HAD-204(6)	51		
GF-205-370				HAD-204(6)	51		
GF-205-380				HAD-204(6)	51		

JIN MING 進明

MODEL	PART NO.	WITH BC/CAP	EX. ITEM	HIROSE HOOK		BOBBIN CASE	
				ITEM	PAGE	PART NO.	ITEM
JM-810				HSH-31(6)	43		
JM-820				HSH-31(6)	43		
JM-8810				HPF-490(A)	43		CP-HPF151
JM-8820				HPF-490(A)	43		CP-HPF151

K-CHANCE 高機

MODEL 縫紉機機種	PART NO. 型号	WITH BC/CAP 配BC/CP	EX. ITEM 专卖品	HIROSE HOOK 广濑梭头		BOBBIN CASE 梭芯套	
				ITEM 品名	PAGE 页	PART NO. 型号	ITEM 品名
KBH-780				DP2-NJ771	42		BC-LBH771

KERDER 客德

MODEL	PART NO.	WITH BC/CAP	EX. ITEM	HIROSE HOOK		BOBBIN CASE	
				ITEM	PAGE	PART NO.	ITEM
KD-20U				DB1-Z(20)	38		BC-DBZ(1)
KD-810				HSH-31(12)	43		
KD-8100-3				HSH-7.94B	31		BC-DB1
KD-8100-5				HSH-7.94A	31		BC-DB1
KD-8100-7				HSH-7.94A	31		BC-DB1
KD-820				HSH-31(12)	43		

KING'S 王品

MODEL	PART NO.	WITH BC/CAP	EX. ITEM	HIROSE HOOK		BOBBIN CASE	
				ITEM	PAGE	PART NO.	ITEM
HC-335				DB1-Z16B	38		BC-DBZ(2)
HC-471				HPF-490(A)	43		CP-HPF151
HC-474				HPF-490(A)	43		CP-HPF151
HC-491				HPF-490(A)	43		CP-HPF151
HC-616				HPF-545	48		CP-HPF545
HC-618				HPF-545	48		CP-HPF545
HC-810				HSH-31(12)	43		
HC-815				HSH-31(12)	43		
HC-820				HSH-31(12)	43		
HC-825				HSH-31(12)	43		
HC-832				HSH-12-15M	46		
HC-835				HSH-12-15MM	49		
HC-919				HSH-31(12)	43		
HC-929				HSH-31(12)	43		

KING TEX 精機

MODEL	PART NO.	WITH BC/CAP	EX. ITEM	HIROSE HOOK		BOBBIN CASE	
				ITEM	PAGE	PART NO.	ITEM
KL-300H	600-03040			HSH-7.94B	31	600-03041	BC-DB1
KL-300M	600-03040			HSH-7.94B	31	600-03041	BC-DB1
KL-300M-A	HK111-0002B			HSH-7.94BTR	32	HK111-0001B	BC-DB1-NBL6
KL-310M	600-03040			HSH-7.94B	31	600-03041	BC-DB1
KL-500M	600-03040			HSH-7.94B	31	600-03041	BC-DB1

MILLION SPECIAL 萬特 (YAO HAN 耀瀚)

MODEL 縫紉機機種	PART NO. 型号	WITH BC/CAP 配 BC/CP	EX. ITEM 专卖品	HIROSE HOOK 广濑梭头		BOBBIN CASE 梭芯套	
				ITEM 品名	PAGE 页	PART NO. 型号	ITEM 品名
MS-1245				HPF-1242(A)	48		CP-HPF545
MS-335				DB1-Z16B	38		BC-DBZ(1)
MS-474-500				HPF-490(A)	43		CP-HPF151
MS-491-800				HPF-490(A)	43		CP-HPF151
MS-810				HSH-31(12)	43		
MS-820				HSH-31(12)	43		
MS-B842-3				HSH-12-15M	46		
MS-B845				HSH-12C	46		CP-12C
MS-B872-3				HSH-12-15MM	49		
MS-B875-5				HSH-12MC	50		CP-12MC
MS-491-830				HPF-490A(5)TR	43		CP-HPF144TR
MS-474-530				HPF-490A(5)TR	43		CP-HPF144TR
MS-691-800				HPF-490(A)	43		CP-HPF151
MS-691-830				HPF-490A(5)TR	43		CP-HPF144TR
MS-674-500				HPF-490(A)	43		CP-HPF151
MS-674-530				HPF-490A(5)TR	43		CP-HPF144TR
MS-735				HSH-7.94AO	31		BC-DB1
MS-370L				HSM-A	35		BC-DBM(1)
MS-B842-403				HG12-15L(TR1)	45		
MS-B842-5				HSH-12-15M	46		
MS-B842-405				HG12-15L(TR1)	45		
MS-B845-3				HSH-12C	46		CP-12C
MS-B845-5				HSH-12C	46		CP-12C
MS-B872-403				HG12MC(1)TR	49		CP-G12M(BR)TR
MS-B872-5				HSH-12-15MM	49		
MS-B872-405				HG12MC(1)TR	49		CP-G12M(BR)TR
MS-B875-3				HG12MC(1)TR	49		CP-G12MC(1)TR
MS-B875-403				HG12MC(1)TR	49		CP-G12MC(1)TR
MS-B875-405				HG12MC(1)TR	49		CP-G12MC(1)TR
MS-20U143				DB1-BZ(20)	38		BC-DBZ(1)
MS-B652				DB1-Z16B	38		BC-DBZ(1)

mitsutomo 三友

MODEL	PART NO.	WITH BC/CAP	EX. ITEM	HIROSE HOOK		BOBBIN CASE	
				ITEM	PAGE	PART NO.	ITEM
MT-810				HSH-31(12)	43		
MT-820				HSH-31(12)	43		

NITAKA 日高

MODEL 縫紉機機種	PART NO. 型号	WITH BC/CAP 配 BC/CP	EX. ITEM 专卖品	HIROSE HOOK 广濑梭头		BOBBIN CASE 梭芯套	
				ITEM 品名	PAGE 页	PART NO. 型号	ITEM 品名
DY-3300				HSM-A	35		BC-DBM(1)
DY-350L				HSM-A	35		BC-DBM(1)
DY-370L				HSM-A	35		BC-DBM(1)
DY-3811-L				HSM-A	35		BC-DBM(1)
TC-1341				HYM-1341AY	48		CP-HPF545
TC-1508				HSH-12-15MM(5)	49		
TC-1530				HSM-A	35		BC-DBM(1)
TC-2508				HSH-12-15MM(5)	49		
TC-2530				HSM-A	35		BC-DBM(1)
TC-28B				HSH-12-15MM(5)	49		
TC2-B1883				HSH-12C	46		CP-12C
TC2-B1885				HSH-12MC	50		CP-12MC
TC2-B845				HSH-12-15LC	46		CP-12C
TC2-B875				HSH-12MC	50		CP-12MC
TC2-B935				HSH-12-15MM	49		
TC-810				HSH-31(12)	43		
TC-810S				HSH-31(6)	43		
TC-820				HSH-31(12)	43		
TC-820S				HSH-31(6)	43		
TC-881				HPF-490(A)	43		CP-HPF151
TC-882				HPF-490(A)	43		CP-HPF151
TC-88B				HSH-12-15MM(5)	49		
TC-8B				HSH-12-15MM(5)	49		
TC-B842-403				HG12-15L(TR1)	45		
TC-B842-405				HG12-15L(TR1)	45		
TC-B872-403				HG12MC(1)TR	49		CP-G12M(BR)TR
TC-B872-405				HG12MC(1)TR	49		CP-G12M(BR)TR
TC-B875-403				HG12MC(1)TR	49		CP-G12MC(1)TR
TC-B875-405				HG12MC(1)TR	49		CP-G12MC(1)TR

PANDA 建聯

MODEL	PART NO.	WITH BC/CAP	EX. ITEM	HIROSE HOOK		BOBBIN CASE	
				ITEM	PAGE	PART NO.	ITEM
JL-20U				DB1-Z(20)	38		BC-DBZ(1)
JL-457A				DP2-57(2LP)	41		BC-DP57
JL-781				DP2-NJ771	42		BC-LBH771

SHIANG WANG 象王 (WOEI RONG 偉鎔)

MODEL 缝纫机机种	PART NO. 型号	WITH BC/CAP 配 BC/CP	EX. ITEM 专卖品	HIROSE HOOK 广濑梭头		BOBBIN CASE 梭芯套	
				ITEM 品名	PAGE 页	PART NO. 型号	ITEM 品名
WR-3750				HSM-A	35		BC-DBM(1)
WR-467				HAD-467TR	52		
WR-5705				HSM-A	35		BC-DBM(1)
WR-652				DB1-Z16B	38		BC-DBZ(2)
WR-810				HSH-31(6)	43		
WR-820				HSH-31(6)	43		
WR-9910-1				HPF-490(A)	43		CP-HPF151
WR-9910-T				HPF-490A(5)TR	43		CP-HPF144TR
WR-9918-1				HPF-490(A)	43		CP-HPF151
WR-991-T				HPF-490A(5)TR	43		CP-HPF144TR
WR-992				HPF-490(A)	43		CP-HPF151
WR-9920-1				HPF-490(A)	43		CP-HPF151
WR-9920-T				HPF-490A(5)TR	43		CP-HPF144TR
WR-992-T				HPF-490A(5)TR	43		CP-HPF144TR

SICAMA 寶隆

MODEL	PART NO.	WITH BC/CAP	EX. ITEM	HIROSE HOOK		BOBBIN CASE	
				ITEM	PAGE	PART NO.	ITEM
BEISLER 842				HG12L(1)TR1	45		CP-G12L(1)
BEISLER 845				HG12-15LCTR1	45		CP-G12CTR(1)
LT2-B842				HSH-12-15L	46		
LT2-B842-5				HSH-12-15M	46		
LT2-B842-580				HG12-15L(TR1)	45		
LT2-B845				HSH-12-15LC	46		CP-12C
LT2-B845-380				HSH-12-15LCTR1	46		CP-12CTR(1)
LT2-B848-3				HSH-12-15M	46		
LT2-B848-380				HSH-12-15L(TR1)	46		
LT2-B849-380				HSH-12-15L(TR1)	46		
LT2-B872				HSH-12-15MM	49		
LT2-B872-380				HSH-12-15MM(3)TR	49		
LT2-B872-580				HG12MC(1)TR	49		CP-G12MC(1)TR
LT2-B875				HSH-12MC	50		CP-12MC
LT2-B875-380				HSH-12MC(3)	50		CP-12MC(3)
LT2-B875-5				HSH-12MC	50		CP-12MC
LT2-B875-580				HSH-12MC(3)	50		CP-12MC(3)
YAZICI 842				HG12L(1)TR1	45		CP-G12L(1)
YAZICI 845				HG12-15LCTR1	45		CP-G12CTR(1)

SIRUBA 銀箭

MODEL 缝纫机机种	PART NO. 型号	WITH BC/CAP 配 BC/CP	EX. ITEM 专卖品	HIROSE HOOK 广濑梭头		BOBBIN CASE 梭芯套	
				ITEM 品名	PAGE 页	PART NO. 型号	ITEM 品名
L818F-F1	G111			HSH-7.94B	31	G201	BC-DB1
L818F-H1	G112J			HSH-7.94A	31	G201	BC-DB1
L818F-H1-□	G122J			HSH-7.94ATR	31	G202	BC-DB1-NBL6
L818F-K1	G111			HSH-7.94B	31	G201	BC-DB1
L818F-K1-□	G121			HSH-7.94BTR(10SP)	—	G202	BC-DB1-NBL6
L818F-L1	G111			HSH-7.94B	31	G201	BC-DB1
L818F-L1-□	G121			HSH-7.94BTR(10SP)	—	G202	BC-DB1-NBL6
L818F-M1	G111			HSH-7.94B	31	G201	BC-DB1
L818F-M1-□	G121			HSH-7.94BTR(10SP)	—	G202	BC-DB1-NBL6
L819-X1	G112J			HSH-7.94A	31	G201	BC-DB1
L819-X1-U	G122J			HSH-7.94ATR	31	G202	BC-DB1-NBL6
L819-X2	G131			HSM-A(3)	35	G204	BC-DBM(1)
L819-X2-U	G132			HSM-A1HTR	35	G205	BC-DBM(4)-NBL3
P717	G151			HSH-31(6)	43		
P727	G151			HSH-31(6)	43		
R718-01	G152A			HPF-490A(N)	43	G401	CP-HPF151(A)
R718-01H	G153			HPF-490AH(N)	43	G401	CP-HPF151(A)
R718-01-U	G155			HPF-490A(5)TR	43	G403	CP-HPF144TR
R718-02	G152A			HPF-490A(N)	43	G401	CP-HPF151(A)
R728	G152A			HPF-490A(N)	43	G401	CP-HPF151(A)
R728-□□	G152A			HPF-490A(N)	43	G401	CP-HPF151(A)
R728-U	G155			HPF-490A(5)TR	43	G403	CP-HPF144TR
R728-XXH	G153			HPF-490AH(N)	43	G401	CP-HPF151(A)
T828-41	G162			HG12L(1)	45	G406	CP-G12L(1)
T828-41-LL	G161			HG12-15L	45		
T828-41-ML	G161			HG12-15L	45		
T828-42	G162			HG12L(1)	45	G406	CP-G12L(1)
T828-42-HL-U	G163			HG12-15L(TR1)	45		
T828-42-LL	G161			HG12-15L	45		
T828-42-LL-U	G163			HG12-15L(TR1)	45		
T828-42-ML	G161			HG12-15L	45		
T828-42-ML-U	G163			HG12-15L(TR1)	45		
T828-42-U	G164			HG12L(1)TR1	45	G406	CP-G12L(1)
T828-45-H	G169			HG12-15LC	45	G409	CP-G12C
T828-45-H-U	G170			HG12-15LCTR1	45	G410	CP-G12CTR(1)
T828-45-L	G169			HG12-15LC	45	G409	CP-G12C
T828-45-M	G169			HG12-15LC	45	G409	CP-G12C
T828-45-M-U	G170			HG12-15LCTR1	45	G410	CP-G12CTR(1)
T828-45-X	G169			HG12-15LC	45	G409	CP-G12C
T828-45-X-U	G170			HG12-15LCTR1	45	G410	CP-G12CTR(1)
T828-47	G162			HG12L(1)	45	G406	CP-G12L(1)
T828-47-HL-U	G163			HG12-15L(TR1)	45		

SIRUBA 銀箭

MODEL 缝纫机机种	PART NO. 型号	WITH BC/CAP 配 BC/CP	EX. ITEM 专卖品	HIROSE HOOK 广濑梭头		BOBBIN CASE 梭芯套	
				ITEM 品名	PAGE 页	PART NO. 型号	ITEM 品名
T828-47-LL	G161			HG12-15L	45		
T828-47-LL-U	G163			HG12-15L(TR1)	45		
T828-47-ML	G161			HG12-15L	45		
T828-47-ML-U	G163			HG12-15L(TR1)	45		
T828-47-U	G164			HG12L(1)TR1	45	G406	CP-G12L(1)
T828-48-L	G169			HG12-15LC	45	G409	CP-G12C
T828-48-L-U	G170			HG12-15LCTR1	45	G410	CP-G12CTR(1)
T828-72-HL	G165			HG12M(BR)	49		
T828-72-H-U	G168-A			HG12MC(1)TR	49	G411	CP-G12M(BR)TR
T828-72-ML	G165			HG12M(BR)	49		
T828-72-M-U	G168-A			HG12MC(1)TR	49	G411	CP-G12M(BR)TR
T828-75H	G166			HG12MC(1)	49	G407	CP-G12MC(1)
T828-75-H-U	G168-A1			HG12MC(1)TR	49	G408	CP-G12MC(1)TR
T828-75M	G166			HG12MC(1)	49	G407	CP-G12MC(1)
T828-75-M-U	G168-A1			HG12MC(1)TR	49	G408	CP-G12MC(1)TR
T828-75X	G166			HG12MC(1)	49	G407	CP-G12MC(1)
T828-75-X-U	G168-A1			HG12MC(1)TR	49	G408	CP-G12MC(1)TR
UF916-X2-U	G173			HSH-12-15MM(410M)	49		
UF918-X2	G175			HAD-467TR(1B)	52		
UF918-X2-U	G175			HAD-467TR(1B)	52		
UF926-X2-U	G173			HSH-12-15MM(410M)	49		
UF928-X2	G175			HAD-467TR(1B)	52		
UF928-X2-U	G175			HAD-467TR(1B)	52		
YC619-X2	G135			HSM-A1HTR(T)	35	G205	BC-DBM(4)-NBL3
YF616-X2	G131			HSM-A(3)	35	G204	BC-DBM(1)
YF616-X2-U	G132			HSM-A1HTR	35	G205	BC-DBM(4)-NBL3
YF619-X2	G131			HSM-A(3)	35	G204	BC-DBM(1)
YF619-X2-U	G132			HSM-A1HTR	35	G205	BC-DBM(4)-NBL3

SUNNUN 信能

MODEL	PART NO.	WITH BC/CAP	EX. ITEM	HIROSE HOOK		BOBBIN CASE	
				ITEM	PAGE	PART NO.	ITEM
DY-637				HSM-A	35		BC-DBM(1)
EB-883				DB1-Z16	38		BC-DBZ(1)
YU-740				HSM-A	35		BC-DBM(1)

TAKING 天王星

MODEL 縫纫机机种	PART NO. 型号	WITH BC/CAP 配 BC/CP	EX. ITEM 专委品	HIROSE HOOK 广濑梭头		BOBBIN CASE 梭芯套	
				ITEM 品名	PAGE 页	PART NO. 型号	ITEM 品名
TK-1245				HPF-1242(A)	48		CP-HPF545
TK-1246				HPF-1242(A)	48		CP-HPF545
TK-545				HPF-545	48		CP-HPF545
TK-546				HPF-545	48		CP-HPF545
TK-591				HPF-490(A)	43		CP-HPF151
TK-591T				HPF-490(5)TR	43		CP-HPF144TR
TK-592				HPF-490(A)	43		CP-HPF151
TK-592T				HPF-490(5)TR	43		CP-HPF144TR
TK-691				HPF-490(A)	43		CP-HPF151
TK-691T				HPF-490(5)TR	43		CP-HPF144TR
TK-692				HPF-490(A)	43		CP-HPF151
TK-692T				HPF-490(5)TR	43		CP-HPF144TR
TK-810				HSH-31(12)	43		
TK-820				HSH-31(12)	43		
TK-832				HSH-12-15M	46		
TK-832-LB5				HSH-12-15MM	49		
TK-86				HSH-12-15MMJ	49		
TK-872				HSH-12-15MM	49		
TK-888				DP2-NJ771	42		BC-LBH771
TK-89				HSH-7.94B	31		BC-DB1
TK-8BL				HSM-A(6)	35		BC-DBM(2)-NBL2
TK-991				HPF-490(A)	43		CP-HPF151
TK-992				HPF-490(A)	43		CP-HPF151

TONY 輝煌 (HUEI HWANG)

MODEL	PART NO.	WITH BC/CAP	EX. ITEM	HIROSE HOOK		BOBBIN CASE	
				ITEM	PAGE	PART NO.	ITEM
H-130-LHA				HSH-7.94A	31		BC-DB1
H-301				DBM-A(Z14)	35		BC-DBM(Z1)NBL1
H-305				DBM-A(Z14)	35		BC-DBM(Z1)NBL1
H-370-LHA				HSM-A	35		BC-DBM(1)

YULUN 友倫

MODEL 縫紉機機種	PART NO. 型号	WITH BC/CAP 配 BC/CP	EX. ITEM 专卖品	HIROSE HOOK 广濑梭头		BOBBIN CASE 梭芯套	
				ITEM 品名	PAGE 页	PART NO. 型号	ITEM 品名
475A-105L				DP2-57(2LP)	41		BC-DP57
475A-125L				DP2-57(2LP)	41		BC-DP57
475A-135L				DP2-57(2LP)	41		BC-DP57
475A-140L				DP2-57(2LP)	41		BC-DP57
475A-143NL				DP2-57(3LP2R)	41		UNAVAILABLE
475A-505-PBG-NHL				DP2-457U(T)	41		BC-DP57
475A-525-PBG-NHL				DP2-457U(T)	41		BC-DP57
475A-535-PBG-NHL				DP2-57(3LP2R)	41		UNAVAILABLE
475A-543-PBG-NHL				DP2-57(3LP2R)	41		UNAVAILABLE
475A-605-NCB-LG				DP2-457U(T)	41		BC-DP57
475A-625-NCB-LG				DP2-457U(T)	41		BC-DP57
475A-635-NCB-LG				DP2-57(3LP2R)	41		UNAVAILABLE
475A-643-NCB-LG				DP2-57(3LP2R)	41		UNAVAILABLE
YHL-205M-NCB				DP2-57(2YLMH)	—		BC-DP57
YLM-1245				HPF-1242(A)	48		CP-HPF545
YLM-1246				HPF-1242(A)	48		CP-HPF545
YLM-335				DB1-Z16B	38		BC-DBZ(1)
YLM-340				HSM-A	35		BC-DBM(1)
YLM-350-22				HSM-A	35		BC-DBM(1)
YLM-457A				DP2-57(2LP)	41		BC-DP57
YLM-545				HPF-1242(A)	48		CP-HPF545
YLM-546				HPF-1242(A)	48		CP-HPF545
YLM-572W				HPF-490(A)	43		CP-HPF151
YLM-671W				HPF-490(A)	43		CP-HPF151
YLM-810-G				HSH-31(12)	43		
YLM-820-G				HSH-31(12)	43		

TYPE OF HOOK GIB 梭头压板的分类

HORIZONTAL AXIS 垂直型系列

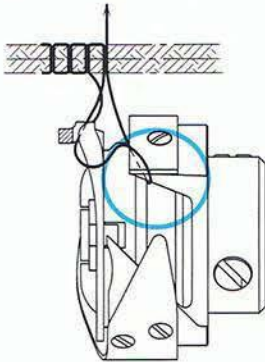

A-TYPE

Short gib
for sewing heavy materials & zigzag/embroidery sewing

A 型 线脱离梭头最快的型号
适用于缝厚料/人字型/绣花机

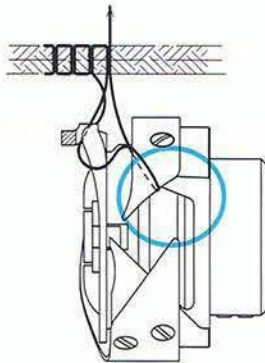

B-TYPE

Full gib
for general use from light to heavy materials

B 型 厚薄料通用

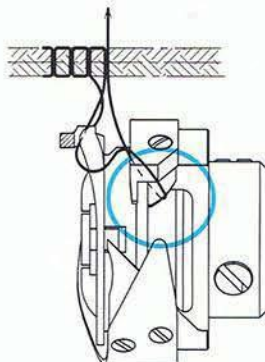

C-TYPE

Tacking gib
for light and medium materials
(with projection to prevent from thread jamming)

C 型 中厚, 薄料兼用
(具有防止夹线的凸型构造)

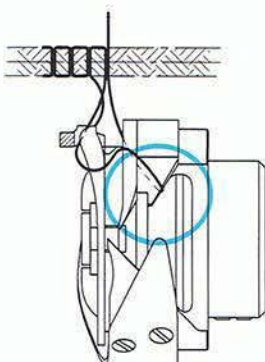

D-TYPE

for light materials
(having both advantages of B & C-type)

D 型 薄料用(兼有 B 型和 C 型的特征)

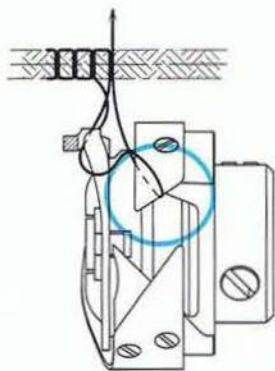

BOH-TYPE

for medium & heavy materials
(comparatively short length Hook gib)

BOH 型 中厚料, 厚料用 (终端尖部短)

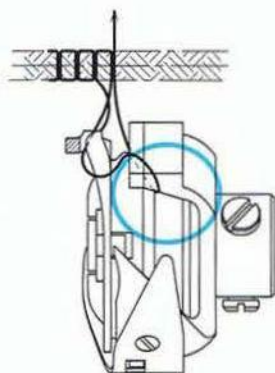

F-TYPE

Short gib (Jam proof gib)
for tailor/home-use machine
(when jamming occurs, this structure allows the thread
to get out without disassembling the hook)

F 型 适用于裁缝铺或家庭用, 与 A 型相同
(夹线不必拆开即可排除)

VERTICAL AXIS 水平型系列

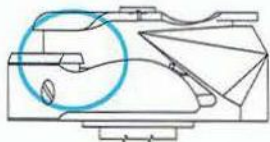

A-TYPE

Short gib for heavy materials
typical use for Post-Bed machine for leather/shoes sewing

A 型 线脱离梭头最快的型号
用于缝皮革厚料的立柱式缝纫机

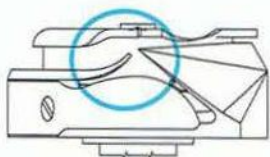

B-TYPE

Full gib
for general use from light to heavy materials

B 型 厚薄料通用

Lubricating system of Rotating Hook and adequate lubrication

梭头的润滑系统和润滑状态

For high speed types hooks, there are two kinds of lubricating systems, one is semi-automatic lubricating system (such as HSH-7.24); which has a structure sucking up some of oil applied to the lower shaft metal, and another is full-automatic lubricating system (such as HSH-7.94); which is designed to lubricate automatically through a central hole of the hook shaft. As to the full-automatic lubricating system, there are two types for the path of lubricant-closed type and open type. A vertical axis hook (such as HSH-12-15L) is designed to suck up oil from an oil tank of sewing machine through the shaft.

DB 型梭头的润滑系统一般有两种;一种是供给轴部的润滑油自动吸收到梭头内部的中速型(HSH-7.24型),另一种是通过缝纫机上的润滑系统强制供油的自动润滑型(HSH-7.94型)。自动润滑型又可分为密封型和开放型。水平梭头 I 型(HSH-12-15L 型), II 型(HG12-15L 型)是通过轴孔从底部的油槽吸油而润滑。

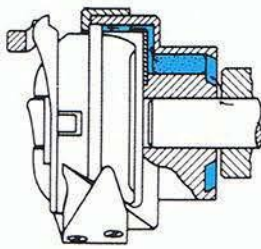

Semi-automatic system
中速型

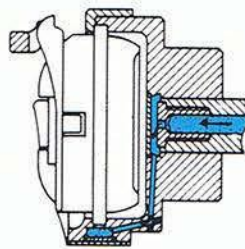

Full-automatic system-closed type
自动润滑封闭型

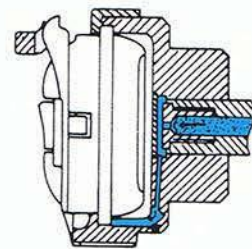

Full-automatic system-open type
自动润滑开放型

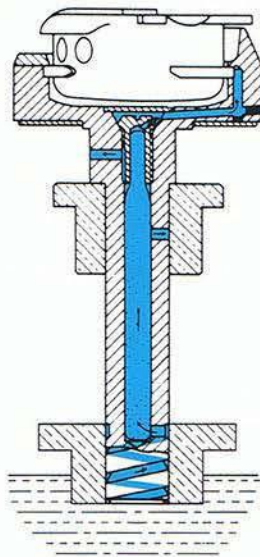

Full-automatic system
vertical axis hook
水平梭头 I 型

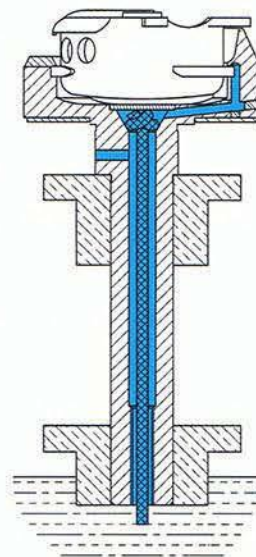

Full-automatic system
vertical axis hook
水平梭头 II 型

To judge lubricating condition into automatic lubricating type hooks (such as HSH-7.94, HSM, etc.), put test paper below hook while idling as shown Fig. 1 and check oil flow into the hook by oil mark on the paper.

查看自动润滑型梭头（HSH-7.94, HSM 等）的润滑状况时，一般如图 1 所示，把测试专用纸放在空转的缝纫机梭头下方，观察测试纸上的油迹来判断供油量。

Fig.1 : How to check state of lubrication
查看润滑状况的方法

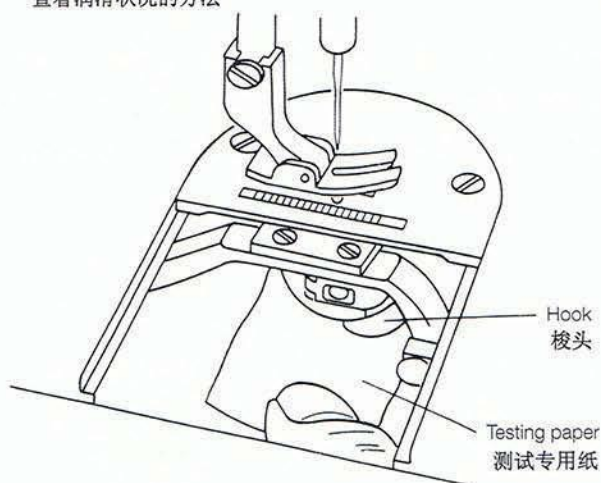
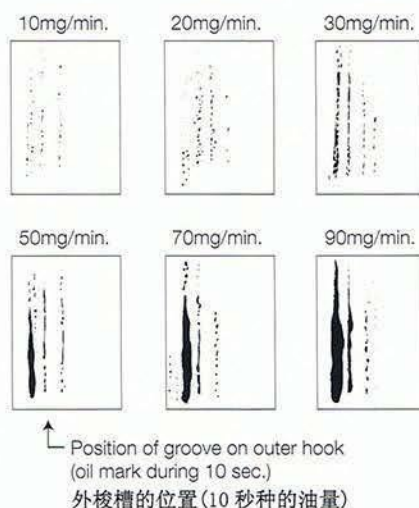

Fig.2 : Oil mark and oil amount.



The oil marks on the testing papers shown in Fig.2 show the state of lubrication in a rotating hook. Adequate lubrication is 10mg/min at minimum and 20-30mg/min generally, though it depends on the speed of the sewing machine.

图 2 中的测试专用纸的油迹表示梭头润滑状况。适当的供油量根据缝纫机的转数需要加以调节。但至少也要保证 10mg/min。最适当的供油量是 20~30mg/min。

Installing of Rotating Hook (Timing) 梭头的安装方法

Install hook into the sewing machine in a manner as described below to use it in the best condition.
为了在最佳的状态下使用广濑梭头，请按照以下的方法安装梭头。

(1) POSITIONING OF NEEDLE BAR 定针杆的位置

Move the needle bar to the lowest position.

In the case it has timing marks, see if an upper one of the two lines accords to the lower edge of the needle bar bushing. If not, adjust the position of the needle bar to make it accord to.

In the case it has no timing marks, adjust the needle bar to make the upper end of the needle eye position (a)mm below the passing way of the hook point. To set a rate (a), which differs depending on sewing machines, refer to the table presented below.

首先把针杆降到最低点。（下死点）

之后，要是针杆上标着基线刻度，就把针杆套的最下端与 2 条基线刻度中的上线对齐。

要是针杆上没有标着基线刻度时，就把针孔上端调整到比梭头尖低 a mm 处。这时 a 值因机种不同而不同，请参考下表。

(2) TIMING OF ROTATING HOOK (Timing) 定梭头尖的位置

Mount the hook so as to make the hook point accord to the center of the needle when the needle bar rises from its lowest position and the lower line of the timing marks accords to the lower edge of the needle bar bushing.

In the case there are no timing marks, mount the hook so as to make the hook point accord to the center of the needle when the needle bar rises to a position (b)mm above its lowest position. To find the space (b), which differs depending on sewing machines, refer to the table presented below.

An appropriate space between the hook point and the needle is 0.05 to 0.1mm (equivalent to a thickness of letter paper).

把针杆从最低点提起, 使针杆套的最下端与 2 条基线刻度中的下线对齐. 这时把梭头尖调到针的中心位置. 没有基线刻度时, 针杆从最低点提起 b mm, 把梭头尖调到针的中心位置后紧固梭头. b 的值因机种不同而不同, 请参考下表.

这时梭头尖与针的间隙应在 0.05mm 到 0.1mm 之内.

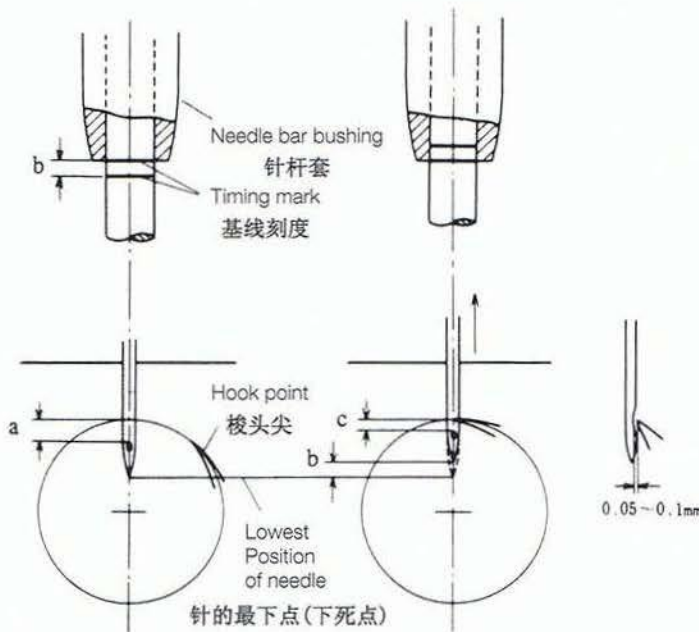

Mounting the hook 梭头的安装

Sewing machine	缝纫机分类	Hirose article 梭头的分类	a	b	c
Single needle lockstitch	单针平缝机	TA1-,DB1-,DA1-, HSH-7.94 series	2.3~3.7	1.8~2.2	0.5~1.5
Two needle lockstitch	双针平缝机	HSH-12-15	2.3~4.0	1.8~2.4	0.5~1.6
Zigzag stitch	人字型缝机	DP2	4.0	2.4	1.6
Hemstitch	边缝机	HSH-18-4	4.0	2.4	1.6
Binding stitch	卷边机	HSH-8-20	4.0	2.4	1.6

COMPONENT PARTS

各零件的名称

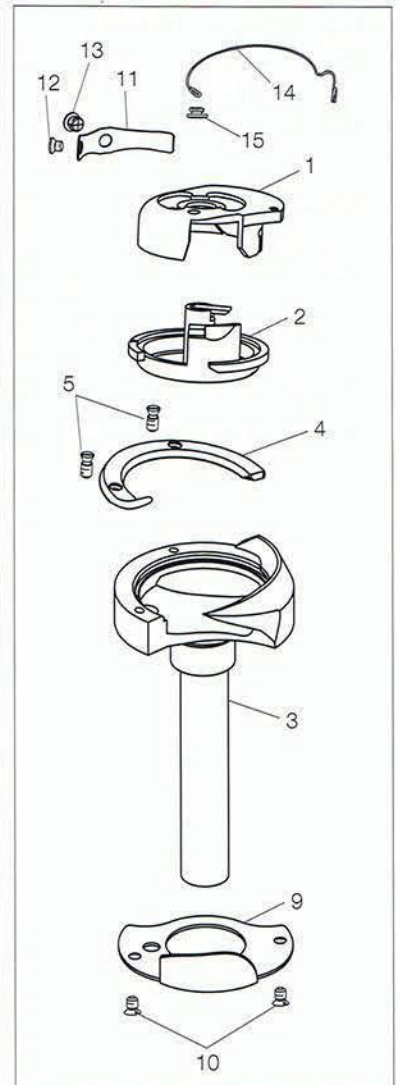
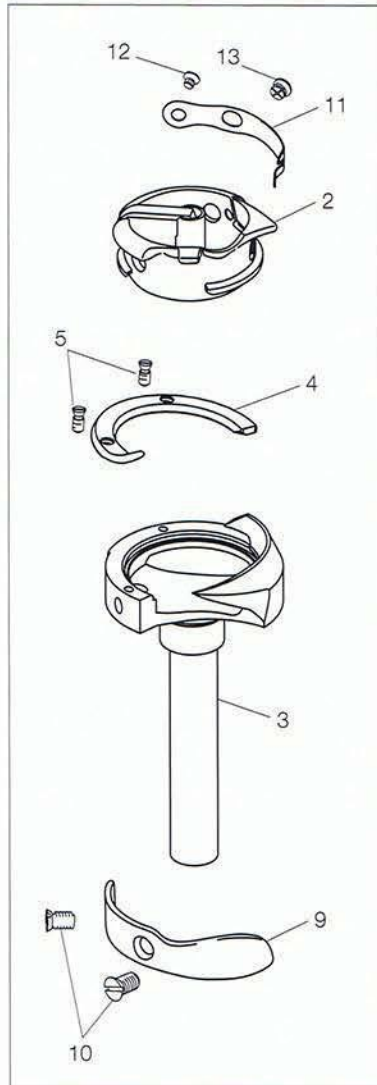
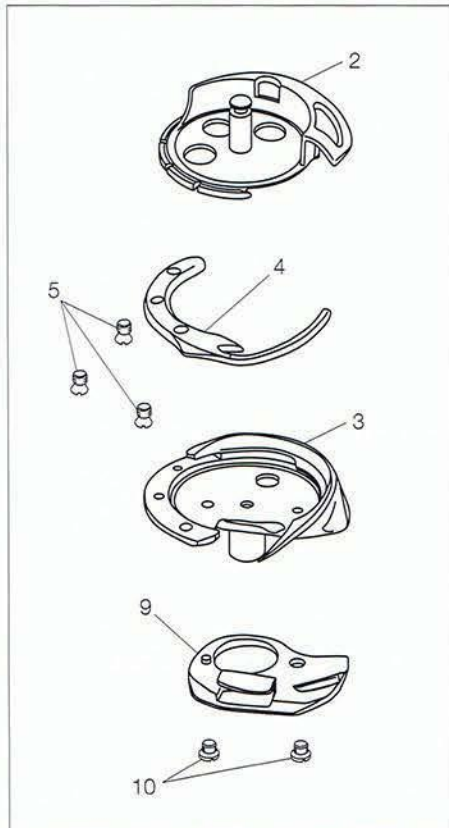
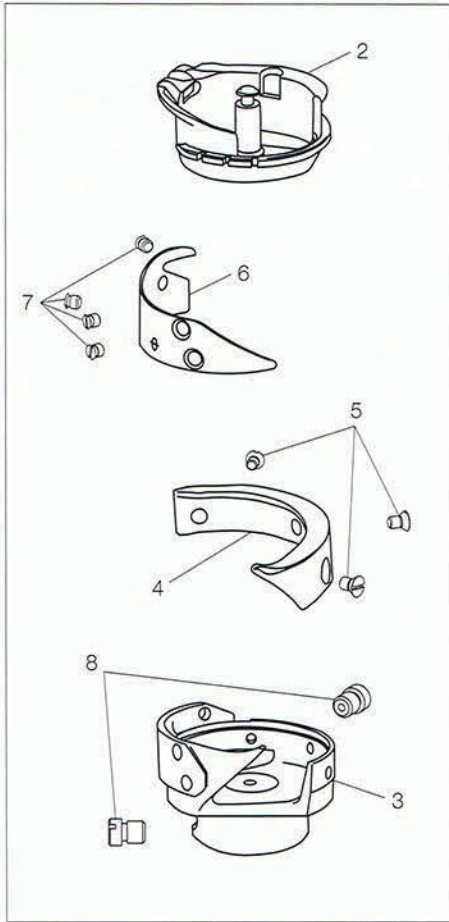

No.	Name	
1	Bobbin case/cap	梭芯套/梭帽
2	Inner hook	内梭
3	Outer hook	外梭
4	Hook gib	压板
5	Hook gib screw	紧固压板螺钉
6	Thread guard	导线片
7	Thread guard screw	紧固导线片螺钉
8	Set screw	紧固外梭螺丝
9	Needle guard	托针板
10	Needle guard screw	紧固托针板螺钉
11	Tension spring	调梭芯线张力片
12	Tension spring screw	紧固调梭芯线张力片螺钉
13	Regulating screw	调张力螺钉
14	Thread control spring	防梭芯线松弛簧
15	Thread control spring screw	紧固防梭芯线松弛簧螺钉

RP-SERIES RP系列

OIL-FREE HOOK 无需注油梭头

PLASTIC COATED RACE WAY
内梭凸轨上涂一层特殊塑料

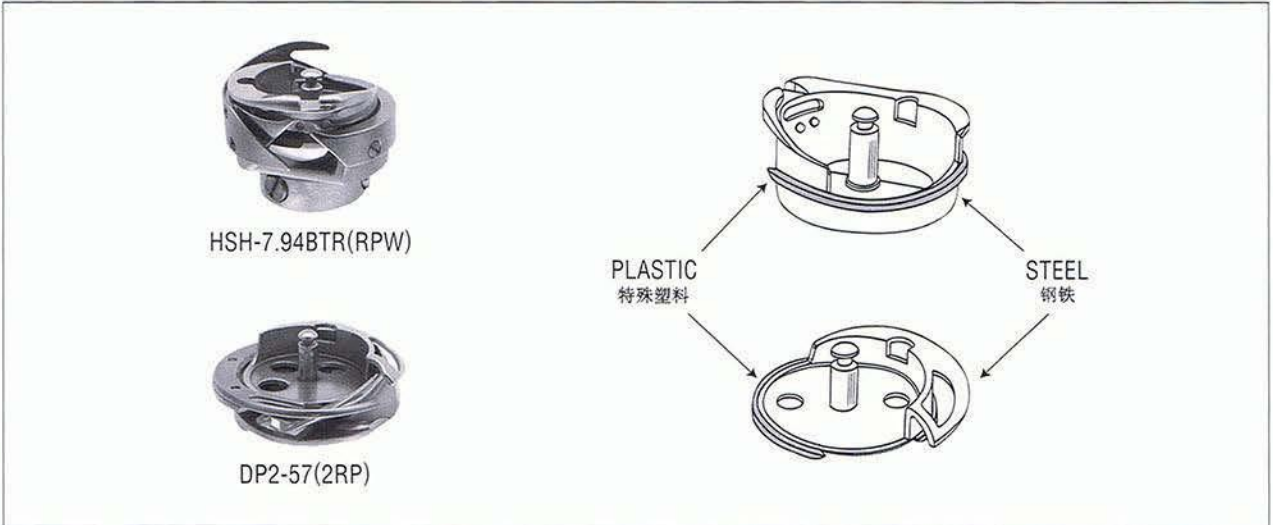

- 1) Keeps sewing material & thread being no stain from oil.
彻底解决了布料和缝线的油污烦恼
- 2) Smooth & noise-less running.
运转平稳, 噪音小。
- 3) Steel bobbin case base protect damage from needle hitting.
内梭的托针部使用钢铁, 能防止因针碰撞托针部而引起的破损。
- 4) Effective for thin material (lingeriess etc.)
适宜与缝薄料(如内衣)

APPLICATION	ITEM
For under trimming machine	
usable in place of conventional hook HSH-7.94BTR	HSH-7.94BTR(RPW)
BROTHER S-7200A-435,S-7200A-45S	※ HSH-7.94BTR(1RPWL)
DURKOPP/ADLER 271	※ HDU-271(QRP)
JUKI DDL-9000DF,DS	※ HSH-7.94BTR(2SPRPWS)
PFAFF 1053	HSH-7.94BTR(RPW)
PFAFF 487NL,489NL,563NL	HPF-563TR(RP)
For embroidery machine	
	HSH-7.94ATR(MQRP)
	HSH-7.94ATR(MQRPW)
	HSH-7.94ATR(MTQRP)
For zigzag sewing machine	
usable in place of conventional hook DP2-57(2)	DP2-57(2RP)
usable in place of conventional hook DP2-57(2LP)	DP2-57(2LPRP)
JUKI LZ-2290A-DS-7-CB,LZ-2290A-DU-7-CB	※ DP2-57(3LP2VRPW)

BOBBIN THREAD LARGE CAPACITY HOOK 梭芯线增量梭头
HTH-SERIES HOOK SETS HTH系列梭头
170% BOBBIN THREAD AVAILABLE
 梭芯线增量 170%

* Comparing with standard bobbin, 170% more bobbin thread can be wound making the bobbin change frequency reduce and also, lessening the stitch-link troublesome. Especially, suitable for long-cloth sewing.
 梭芯线的卷量比一般的增加了170%。因此减少了更换梭芯线的次数和缝线的接头, 提高了缝制效率。适用于缝制缝距长的产品。

CONVENTIONAL	HTH-series
 HSH-7.94BTR	 HTH-BTR(E)
 BC-DB1-NBL6	 BC-HTH(E)
 BO-95(A)	 BO-HTH(A)

BOBBIN THREAD WINDING CHART 梭芯线的卷量

	CONVENTIONAL 一般	HTH-series HTH系列梭头
POLYESTER	26.6m	43.9m
SPUN 30/3	(100%)	(165%)
POLYESTER	43.5m	72.4m
SPUN 50/3	(100%)	(166%)
POLYESTER	54.4m	92.7m
SABA 120C/2	(100%)	(170%)
POLYESTER	70.6m	116.3m
FILAMENT 50/3	(100%)	(165%)
COTTON 8	10.0m	15.0m
	(100%)	(150%)

APPLICATION	ITEM
For under trimming machine	
usable in place of conventional hook HSH-7.94BTR	HTH-BTR(E)
usable in place of conventional hook HSH-7.94ATR	HTH-ATR(E)
BROTHER BAS-7610	※ HTH-BTR(HPNG)
JUKI AVP-875A	※ HTH-BTR(2SPHPNG20E)
JUKI DLN-6390-7	※ HTH-614BTR(2E)
UNION SPECIAL 63900AML	HTH-614BTR(QE)
UNION SPECIAL 63900AML	HTH-614BTR(1.7QE)
For embroidery machine	
usable in place of conventional hook HSH-7.94ATR(MTQ)	HTH-ATR(MQE)
SWF C-WE1206-75,H-WD920-55,B-UK1204-45	※ HTH-ATR(MQESU)
SWF C-WE1206-75,H-WD920-55,B-UK1204-45	※ HTH-ATR(MQESUL)
SWF C-WE1206-75,H-WD920-55,B-UK1204-45	※ HTH-ATR(MQESUNL)

BOBBIN THREAD LARGE CAPACITY HOOK 梭芯线增量梭头
HTM-SERIES HOOK SETS HTM系列梭头
140% BOBBIN THREAD AVAILABLE
 梭芯线增量 140%

* In comparison with so-called 2 times large capacity HSM type bobbin, 140% more bobbin thread can be wound. Other features of HTM series hooks are same as HTH series.

梭芯线的卷量比两倍梭头HSM增加了140%。其他与HTH系列相同。

BOBBIN THREAD WINDING CHART 梭芯线的卷量

	CONVENTIONAL 一般	HTM-series HTM系列梭头
POLYESTER SPUN 30/3	48m (100%)	68m (142%)
POLYESTER SPUN 50/3	78m (100%)	114m (146%)
POLYESTER SABA 120C/2	98m (100%)	141m (141%)
POLYESTER FILAMENT 50/3	135m (100%)	194m (144%)
COTTON 8	18m (100%)	26m (144%)

APPLICATION	ITEM
For without under trimming machine usable in place of conventional hook HSM-A	HTM-A
For under trimming machine usable in place of conventional hook HSM-A1HTR BROTHER BAS-761, BAS-7610	HTM-A1HTR ※ HTM-BTR(HP761)

HP SERIES HP系列

SUPER HARD POINT HOOK 硬尖梭头

EXCELLENT HOOK POINT
FOR WEAR & SHOCK-PROOF
耐磨耐冲极佳梭头尖



Black colored box
黑色包装盒



HSH-7.94BTR(HP)



DP2-457(HP)

- * Long durability.
延长了使用寿命
- * Prevent from thread skipping, thread breakage.
防止跳针, 断线
- * Recommendable for High speed zigzag/pattern sewing & embroidery.
适宜于高速人字型缝机和花样机, 绣花机。

APPLICATION	ITEM
For without under trimming machine usable in place of conventional hook HSH-7.94B	HSH-7.94B(HP)
For under trimming machine usable in place of conventional hook HSH-7.94BTR	HSH-7.94BTR(HP)
BROTHER BAS-7610	※ HTH-BTR(HPNG)
BROTHER BAS-346E,366E	※ HSM-BRTR(HP370)
JUKI AVP-875A	※ HTH-BTR(2SPHPNG20E)
For zigzag sewing machine usable in place of conventional hook DP2-57(2)	DP2-457(HP)
usable in place of conventional hook DP2-57(2LP)	DP2-457(LHP)
usable in place of conventional hook DP2-57(2TS)	DP2-57(2HPTS)
usable in place of conventional hook DP2-57(3LP2R)	DP2-57(3LP2RHP)
JUKI LZ-2282-N-7,2284N-7	※ DP2-57(3LP2VHP)
For twin-needle sewing machine usable in place of conventional hook HSH-21-40	HSH-21-40(HP)