



Koban

HOOKS & CASES

Koban Hook Bobbin Case Shuttle Hook



- ▶ CLASSIFIED LISTING AND DESCRIPTION
- ▶ WEIGHT AND MEASUREMENT TABLE
- ▶ NON SLIP SPRING : NS
- ▶ COMPONENT PARTS
- ▶ REFERENCE TO SEWING MACHINES
- ▶ VARIETIES OF HOOK GIBS
- ▶ WONDER HOOK (PATENTED)
- ▶ DLC (Diamond Like Carbon) Coating
- ▶ ADJUSTABLE STRONG NEEDLE GUARD

SABUN INDUSTRIAL CO., LTD. JAPAN

株式会社 佐文工業所 日本

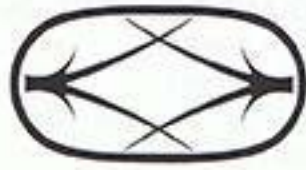

Hooks & Cases



SABUN INDUSTRIAL CO., LTD.



TABLE OF CONTENTS (内容一览)

1.CLASSIFIED LISTING AND DESCRIPTION (分类和说明)	1
ROTARY HOOK HIGH SPEED TYPE : KHS (高速型)	1
LARGE TYPE : KHS20 (大型号)	13
LOW SPEED TYPE : KR (低速型)	19
VERTICAL TYPE : KRP (水平型)	24
STANDARD TYPE WITH SHAFT : KRT (长轴)	26
LARGE TYPE WITH SHAFT : KRT (长大)	33
STANDARD TYPE WITHOUT SHAFT : KRT (水平短轴)	41
LARGE TYPE WITHOUT SHAFT : KRT (水平短大)	49
SPECIAL TYPE : KRT (水平特殊)	53
MISCELLANEOUS PARTS: KSP (各种类型)	55
CAP: SCP (梭帽)	56
BOBBIN CASE STANDARD TYPE : SC (标准型)	64
LARGE TYPE : SC (大旋梭型)	69
SPECIAL TYPE : SC (特殊型)	72
SHUTTLE HOOK : SH (摆梭)	76
2.WEIGHT AND MEASUREMENT TABLE (重量尺寸表)	81
3.NON SLIP SPRING : NS (防止空转弹簧片)	87
4.COMPONENT PARTS (构成零件)	88
5.REFERENCE TO SEWING MACHINES (厂商名一览)	89
ABLE (美宝)	91
BAOMA (宝马)	91
BARUDAN (百灵达)	91
BEYOUNG (本佳)	92
BROTHER (兄弟)	92
BUTTERFLY (蝴蝶)	96
CHIKON (奇钢)	96
CHUAN NENG (传能)	96
CHURCHILL (求精)	97
CONSEW (康秀)	97
CUEY FENG (贵峰)	98
DADILI (大地利)	98
DALIAN (大连)	99
DURKOPP/ADLER (杜克普 / 爱华)	99
FANG HUNG (PLATINA)	99
FEIYUE (飞跃)	100
FENG YING (鋒颖)	100
FLYINGMAN (飞人)	100
FOMAX	101
GEMSY (宝石)	101
GOLDEN WHEEL (金轮)	101
HIGHLEAD (海菱)	105
HUANAN (华南)	106
JACK (杰克)	107
JANOME (真善美)	107
JUKI (重机)	108







JUMBO KING (象王)113
K-CHANCE (高機)113
KERDER (客德)114
KING'S (王品)114
KINGTEX (精機)114
MEIJA (美佳)114
MELCO114
MILLION SPECIAL (萬特)115
mitsubishi (三菱)116
NECCHI (尼奇)118
NITAKA (日高)118
PANDA (建聯)120
PEGASUS (飛馬)120
PEMAL (良機)120
PFAFF (百福)120
PROTEX (通字)122
RICHPEACE (宝盈)123
SANGOOD (双角)123
SEIKO (精工)123
SHANGGONG (上工)126
SICAMA (安機)126
SINGER (勝家)127
SIRUBA (高林)132
STAGER (津久井)134
SUNNUN (信能)134
SUNSTAR (日星)135
TAJIMA (田島)136
TAKING (天王星)136
TANG (經緯)138
TOYOTA (豐田)138
TREASURE (珠寶)139
TYPICAL (標準)139
TYPICAL WANPING (莞坪)140
UNICORN (神馬)141
UNION SPECIAL (於仁)142
YAKUMO (八云)142
YAMATO (大和)144
YULUN (友倫)144
YXSM (裕祥)144
ZGM (珠光)144
ZOJE (中捷)145
ZSK146
6.VARIETIES OF HOOK GIBS (旋梭压板的种类)147
7.WONDER HOOK (PATENTED)148
8.DLC (Diamond Like Carbon) Coating (像钻石一样坚硬的石炭)149
9.ADJUSTABLE STRONG NEEDLE GUARD (护针片调整旋梭)150



1. CLASSIFIED LISTING AND DESCRIPTION (分类和说明)

ROTARY HOOK HIGH SPEED TYPE : KHS

KOBAN NO	MAKER	PART NO	MACHINE
KHS11S-58  7.24 φ 10mm SLOT (針窓)	JUKI (重机)	B18305810A0	LZ-582 ~ 586
KHS1183-SP  7.94 φ KHS1183-SPICC HOOK BASE DLC COATING (像鑽石一樣堅硬的石炭塗層)	PFAFF (百福)	91-262250-91	1181, 1183
KHS12-2S  7.94 φ TWO SCREWS (2本ネジ)	JUKI (重机)	B18301270A0	DDL-5530N, -5550N DLM-5200N, -5210N DLU-5490, -5490N
	BROTHER (兄弟)	S09129-001	DB2-B706-1, 3, -B714-3, -B735-1, -3 DB2-B736, -3, -B755-3, -B757-3, -5, -B758 DB2-B773, -B777, -B781-1, -2, -3 DB2-B792-003, -013, -015, -017, -3 DB2-B793-3, -B795-013
	GOLDEN WHEEL (金輪)		CS-5100, 5200
	SUNSTAR (日星)		KM-123A, -137A
	UNICORN (神馬)		DB2-H310, -H510
KHS12-G  7.94 φ FOR SINGLE NEEDLE LOCK STITCHER	SINGER (勝家)	143342	281-81
KHS12-GP  7.94 φ THREAD TRIMMER (自動糸切)			



ROTARY HOOK HIGH SPEED TYPE : KHS

KOBAN NO	MAKER	PART NO	MACHINE
KHS12-GTH 	JUKI (重机)	D1830415HA0	DDL-227H, -227 L, -555H
	TOYOTA (豊田)	2110904-310	AD140B, 146G, 148B, 150G, 156G, 157G
	CONSEW (康秀)		230B, 231RH, 291RH
	SUNSTAR (日星)		KM-1239, 137B, 350B
	SHANGGONG (上工)		GC15-3, -4
	TYPICAL (標準)		GC6-8A, B
7.94 φ			
KHS12-GTHPD 	MITSUBISHI (三菱)	MF42B0120	LS2-1180-H
	TOYOTA (豊田)		AD340B-22
	SUNSTAR (日星)		KM-235B
	UNICORN (神馬)		DB2-H360
	GOLDEN WHEEL (金輪)		CS-7500BT
	TYPICAL (標準)		GC6-8-D2
7.94 φ	HIGHLEAD (海菱)		GC0518-H-D, GC128-H-D3
KHS12-GTPN2D2 	JUKI (重机)	21209952	DSC-244-4, -7 DSC-244V-4, -7 DSC-245-4, -7 DSC-245V-4, -7
	YAKUMO (八云)	21209952	6B1
7.94 φ			
KHS12-GTPND2 	JUKI (重机)	B18302450A0	DSC-244, -245
7.94 φ			
KHS12-R 	BROTHER (兄弟)	111275-901	DB2-B706-5, -B714-5, -B755-5
	MITSUBISHI (三菱)	MF42A0120	DB-130-12, DY350-12 LS2-1130H, -1280-H1TW
	YAKUMO (八云)	104114010	DSN-178-3
	JANOME (真善美)	703-504-009	DB-J705, J706
	GOLDEN WHEEL (金輪)		CS-1100, 5100, 5150, 7500
	JUMBO KING (象王)		WR-1130
	TYPICAL (標準)		GC6-8, GC203, GC6150M/H
	HIGHLEAD (海菱)		GC128-H, 188-H, 6-28-1H
	SINGER (勝家)		400W, 402W, 451K
	NITAKA (日高)		TTC-15506
	SIRUBA (高林)		L818F-H, 819, 819-X1
	TAKING (天王星)		TK-89H
	UNICORN (神馬)		DB2-H311, -H312, -H510H, -H515H
	GEMSY (宝石)		7-28H, 5590H, 8700H, 8900H
	NITAKA (日高)		TTC-15506
	HUANAN (蕪南)		GC-10-1H, -10-1P
	PEMAL (良機)		CDL-1388N
KHS12-RB 7.94 φ FOR B/G NEEDLE (太針用)			

ROTARY HOOK HIGH SPEED TYPE : KHS

KOBAN NO	MAKER	PART NO	MACHINE
☆KHS12-RBPT2	TAJIMA (田島)	050230060012	
			
7.94 φ FOR BIG NEEDLE (太針用) FOR EMBROIDERY MACHINE (刺繍用)			
KHS12-RD	BROTHER (兄弟)	140882-901	DB2-B790-5, -B791-5
	PROTEX (通字)		TY-B721-5
			
7.94 φ			
KHS12-RP	JUKI (重机)	B1830555BAG	DDL-5550U-4,
	GOLDEN WHEEL (金輪)		CS-5150-5BT, 5100H-BT, 5100HL-BT CS-6000BT, 7500-5BT
	SIRUBA (高林)		LB18-H1-13, LB19-X1-13
			
7.94 φ			
KHS12-RPN2D2	YAKUMO (八云)	21209051	681
			
7.94 φ			
KHS12-RY	SUNSTAR (日星)		SWF/A-T1201, -UK1204-45, -WE1218
	TYPICAL (標準)		GYD12-6, 20-6, 7-6
	MEIJA (美佳)		GG70701
	RICHPEACE (宝盛)		RPEB-FN, CL, MC
			
7.94 φ FOR EMBROIDERY MACHINE (刺繍用)			
KHS12-RY3N			
			
7.94 φ WITH TEFLON BASE (特氟隆内蓋) FOR EMBROIDERY MACHINE (刺繍用)			







ROTARY HOOK HIGH SPEED TYPE : KHS





KOBAN NO	MAKER	PART NO	MACHINE
KHS12-RYN			
			
7.94 φ WITH TEFLON BASE (特氟隆內蓋) FOR EMBROIDERY MACHINE (刺繡用)			
KHS12-RYNW	BARUDAN (百灵达)	KF220750	
			
7.94 φ WITH TEFLON BASE (特氟隆內蓋) WONDER HOOK (萬得旋梭) FOR EMBROIDERY MACHINE (刺繡用)			
KHS12-RYOE			
			
7.94 φ ECCENTRIC HOOK (偏心旋梭) FOR EMBROIDERY MACHINE (刺繡用)			
KHS12-RYP	TAJIMA (田島)	ME05050212RY	TEJT, TFGN, TFKN, TFMX, TMCE, TMLH
	BARUDAN (百灵达)		BEDR, BEDS, BEDT, BEDX, BEDY, ELITE
	TOYOTA (豐田)	2161914-310	AD830
	MELCO		
	RICHPEACE (宝盈)		RPED-FN, MC, CL, CS, TC, RPEC-T, RPEB-FN, CL, MC RPMR, RPQ-E
7.94 φ FOR EMBROIDERY MACHINE, THREAD TRIMMER (刺繡、自動糸切)			
KHS12-RYPAICC	TOYOTA (豐田)	2161924-310AD851	
			
7.94 φ HOOK BASE DLC COATING (像鑽石一樣堅硬的石炭塗層) FOR EMBROIDERY MACHINE, THREAD TRIMMER (刺繡、自動糸切)			

ROTARY HOOK HIGH SPEED TYPE : KHS

NOON YRATOR



KOBAN NO	MAKER	PART NO	MACHINE
KHS12-RYPICC  7.94 φ HOOK BASE DLC COATING (像鑽石一樣堅硬的石炭塗層) FOR EMBROIDERY MACHINE, THREAD TRIMMER (刺繡、自動糸切)			
KHS12-RYPN  7.94 φ WITH TEFLON BASE (特氟隆內蓋) FOR EMBROIDERY MACHINE, THREAD TRIMMER (刺繡、自動糸切)			
KHS12-RYPNW  7.94 φ WITH TEFLON BASE (特氟隆內蓋) WONDER HOOK (萬得旋梭) FOR EMBROIDERY MACHINE, THREAD TRIMMER (刺繡、自動糸切)	BARUDAN (百灵达)	KF220710	
KHS12-RYPOE  7.94 φ ECCENTRIC HOOK (偏心旋梭) FOR EMBROIDERY MACHINE, THREAD TRIMMER (刺繡、自動糸切)			
KHS12-RYPOEJ  7.94 φ ECCENTRIC HOOK (偏心旋梭) FOR EMBROIDERY MACHINE, THREAD TRIMMER (刺繡、自動糸切)	RICHPEACE (宝盈)	RPE0-FH	

ROTARY HOOK HIGH SPEED TYPE : KHS

KOBAN NO	MAKER	PART NO	MACHINE
☆KHS12-RYPOEBW3	BARUDAN (百灵达)	KF221061	BEDS, BEDT, BEDX, BEDY, ELITE
			
7.94 φ ECCENTRIC HOOK (偏心旋梭) WONDER HOOK (萬得旋梭)			
☆KHS12-RYPOEBW3	BARUDAN (百灵达)	KF221061	BEDS, BEDT, BEDX, BEDY, ELITE
7.94 φ ECCENTRIC HOOK (偏心旋梭) WONDER HOOK (萬得旋梭)			
☆KHS12-RYPOET2	TAJIMA (田島)	050210190015	TEJT, TFGN, TFKN, TFMX, TMCE
			
7.94 φ ECCENTRIC HOOK (偏心旋梭)			
☆KHS12-RYPT2	TAJIMA (田島)	050210170016	TEJT, TFGN, TFKN, TFMX, TMCE
			
7.94 φ			
KHS12-RYPW	BARUDAN (百灵达)	KF220970	BEDR, BEDS, BEDT, BEDX, BEDY, ELITE
			
7.94 φ WONDER HOOK (萬得旋梭)			

ROTARY HOOK HIGH SPEED TYPE : KHS

KODI PRATCH

KOBAN NO	MAKER	PART NO	MACHINE
KHS12-S  7.94 φ THREE SCREWS (3支螺絲)	MITSUBISHI (三菱)	MF16A0120	DB-130-10, LS2-1130-MOB, LS2-150-MOB
	TOYOTA (豊田)	2120604-310	AD148, 148M, 156, 156M, 338, 345, 352
	YAKUMO (八云)	104114020	DSN-165, -170, -178
	JANOME (真善美)	701-505-004	DB-J701, 702, 703, 704, 707, 708
	GOLDEN WHEEL (金輪)		CS-1100F, 5100, 5150S, 5200, 6000
	MILLION SPEICAL (萬特)		MS-735, B735R
	SIRUBA (高林)		LB18F-DM, F1, K1, L, L1, M, M1, RM1
	TAKING (天王星)		TK-89
	TYPICAL (標準)		GC203, GC38-1, -2 GC40-1, -2, -4, GC6-1, 6-28, 69-1
	HUANAN (華南)		GC10-1, -1B, -1S GC281B, 281H, 281P, 281S GC28-1, -3, -3B, -3H, -3P, -3S
	HIGHLEAD (海晏)		GC0918-1, 2008-M, 6-28-1 GC128-M, 188-M, 188-MC
	KINGTEX (精機)		KL-300M, 310M, 500M
	JACK (杰克)		JK8500
	PEMAL (良機)		CDL-5550N
	PROTEX (通中)		GC39-1, 5550, 628, TY-1130M, 2000, 6180M, 8500
	SHANGGONG (上工)		GC1-3, 15-1, 15-2, 22, 30-1, 30-2, 30-3, 45-1, 8-2
	SUNSTAR (日星)		KM-123A, 137A
	ZOJE (中捷)		ZJ201-1, 8600, 8800
	CONSEW (康秀)	2113004-310	230, 231R, 291R, 318R
	FANG HUNG (PLATINA)		TJ-8700
	FEIYUE (飛躍)		GC15-1, -2, -4, 290, 5530, 5550
	FLYINGMAN (飛人)		GC51-1, 9002, KDD-5570
	GEMSY (寶石)		5550, 7070, 7080, 7-18, 7-28, 8500, 8700, 8900 GEM5550, GEM8, GEM8
	SINGER (勝家)		191D, 281, 366, 400W, 402W, 451K, 600W
	UNICORN (神馬)		DB2-H310, H510, H515
KHS12-SN 7.94 φ WITH TEFLON BASE (特氟隆內蓋)			
KHS12-SB2  7.94 φ TWO SCREWS (2支螺絲)	BROTHER (兄弟)	S09129-001	DB2-8706-1, -3, -8714-3, -8735-1, -3 DB2-8736, -3, -8755-3, -8757-3, -5 DB2-8758, 773, 777-3, 781-1, -2, -3 DB2-8792-003, -013, -015, -017 DB2-8792-3, -8793-3, -8795-013
KHS12-SB30HO 7.94 φ WITH OPEN OILING HOLE (開放給油)	BROTHER (兄弟)	S03252-901	DB2-8735-5, -8736-5
	TYPICAL (標準)		GC6100HD





SABUN INDUSTRIAL CO., LTD.

☆ = EXCLUSIVE ITEMS







ROTARY HOOK HIGH SPEED TYPE : KHS

ROTARY HOOK

KOBAN NO	MAKER	PART NO	MACHINE
KHS12-SD  7.94 φ NEEDLE FEED (針推布)	JUKI (重机)	B18304150A0	DLN-415, -5410
	BROTHER (兄弟)	143784-901	DB2-B771, -B790, -3, -B791-3
	CONSEW (康秀)	2121604-310B	315R
	SUNSTAR (日星)		KM-350A, -530, 530-7
	TYPICAL (標準)		GC6-10, 6-11, 6160
	HIGHLEAD (海菱)		GC0581
	HUANAN (華南)		GC0301-1, 0302
	PROTEX (通宇)		TY-B721-3
SHANGGONG (上工)		GC0301, 0601-1, 505-1	
KHS12-SJ2  7.94 φ TWO SCREWS (2支螺絲)	JUKI (重机)	B18301270A0	DDL-127, 5530N, NA, -5550N, NA DLM-5200N, -5210N DLU-5490, -5490N
KHS12-SJH  7.94 φ	JUKI (重机)	11092459	DDL-5530NH, NL, -5550NH
KHS12-SOHO  7.94 φ WITH OPEN OILING HOLE (開放給油)	SINGER (勝家)	143342LS	281-81
KHS12-SP  7.94 φ THREAD TRIMMER (自動糸切)	BROTHER (兄弟)	153131-901	BAS-23, 302 DB2-B705-1, 3, 5, -B707-3, -B715-1, -3 DB2-B716-1, -3, -B757-103, -105, -203, -205 DB2-B757-3-0, -403, -405, -503, -505 DB2-B781-103, -104, -203, -204, -3-0, -4 DB2-B781-803, -804, -B792-3-0, -400, -503 DB2-B792-613, -B793, -303, -305, -B795, -313
	MITSUBISHI (三菱)	MF40A0120	LS2-1280-M, -1280-M1T, -2210-M LS2-1180-L1T, -1180-M1T, -1180-M1TW
	SUNSTAR (日星)		KM-235A, 250A, 250A-7, 250B-7, 350-7
	YAKUMO (八云)	112034010	178Y-2
	PROTEX (通宇)		TY-B211-413
	TYPICAL (標準)		GC6-1-D3, GC6710M/HD3
	UNICORN (神馬)		DB2-H360KM-10
	HIGHLEAD (海菱)		GC0918-1D, 128-M-D3, 188-MC-D, 1988-MD GC1988-MDZ, 2008-MD

ROTARY HOOK HIGH SPEED TYPE : KHS

KOBAN TRACTOR

KOBAN NO	MAKER	PART NO	MACHINE
KHS12-SPA3  7.94 φ	TOYOTA (豊田)	2111704-310C	AD1000, 1012G, 157, 2000, 3000 AD340-622, 345-622, 352-702
	CONSEW (康秀)	2111704-310C	290RATCW, 291RATCW, 312RATC, 318-1RATC
KHS12-SPB  7.94 φ THREAD TRIMMER (自動糸切)	BROTHER (兄弟)	S02603-001	DB2-B737, -3, -B738-3, -B774 DB2-B7740, -B7741, -B778, -DD7000
KHS12-SPB3OHO  7.94 φ WITH OPEN OILING HOLE (開放給油)	BROTHER (兄弟)	148846-901	BAS-301 DB2-B707-5, -B715-5, -B716-5 DB2-B737-5, -B738-5, -B790-5-0, -505 DB2-B791-5-0
	TYPICAL (標準)		GC6160H
KHS12-SPD2  7.94 φ	JUKI (重机)	D1830555BA0	DDL-5570N, -5571, -5580N, NA, NK, -5581NA, NK DDL-9000S DLN-5410N-7 DLM-5400-7, N-7, -5410-7, N-6, N-7 DLM-5400N-7 DLU-5490-6, -7, N-6, N-7 DLU-5494-6, N-6, N-7 DMN-5420-6, -7, N-6, N-7
	BROTHER (兄弟)	147101-901	DB2-B790-3-0, -303, -B791-3-0, -333
	GOLDEN WHEEL (金輪)		CS-5100-BT, 5150S-BT
	MTSUBISHI (三菱)	MN35A0120	LS2-2210-M1T, -M1TW
	SIRUBA (高林)		L818F-K1, -L1, M1
	ZOJE (中捷)		ZJ5580-5-D3, 8500-D3, 8850-5-D3
	UNICORN (神馬)		LS2-H5100M, H5150M, H5200, H5300
	JACK (杰克)		JK8900D
	GEMSY (宝石)		8900-7, 8900H-7
	KINGTEX (精機)		KL-300M-A
	FANG HUNG (PLATINA)		TJ-8700-7
	FLYINGMAN (飛人)		KDD-5570-7
	SHANGGONG (上工)		GC30-4-5D, 555-4-5D
	SUNSTAR (日星)		KM-235A, -350A-7

SABUN INDUSTRIAL CO., LTD.

☆ = EXCLUSIVE ITEMS









ROTARY HOOK HIGH SPEED TYPE : KHS

KOBAN NO	MAKER	PART NO	MACHINE
KHS12-SPD3  7.94 φ	TOYOTA (豊田)	2121614-310C	AD340, AD340B-622, AD-341
	CONSEW (康秀)	2121614-310	314RATC, 315-RATC
KHS12-SPD8CC  7.94 φ DLC COATING (像鑽石一樣堅硬的石炭塗層) LITTLE OILING HOOK (微量給油旋梭) FOR THREAD TRIMMER (自動糸切)	JUKI (重机)		DDL-9000D
	BROTHER (兄弟)		S-7200B
KHS12-SPF  7.94 φ FOR FINE NEEDLE (細針用) FOR THREAD TRIMMER (自動糸切)			
KHS12-SPNJW  7.94 φ WITH SHARPE POINT (鋭利剝先) WONDER HOOK (萬得旋梭) FOR THREAD TRIMMER (自動糸切)			
☆ KHS12-SPOE  7.94 φ	JUKI (重机)	D1830555DAB	DLD-436-5, DLN-415-5







ROTARY HOOK HIGH SPEED TYPE : KHS

KOBAN NO	MAKER	PART NO	MACHINE
KHS12-SPOED2  7.94 φ	JUKI (重机)	11038650	DDL-5570N,-5571,-5580N,NA,NK,-5581NA,NK,NU DDL-9000S DLM-5400-7,N-7,-5410-7,N-6,N-7 DLM-5400N-7 DLU-5490-6,-7,N-6,N-7 DLU-5494-6,N-6,N-7 DMN-5420-6,-7,N-6,N-7
KHS12-SPOENPD  7.94 φ	JUKI (重机)	D1830555DAC	ADU992
KHS12-SPOENPD2  7.94 φ	JUKI (重机)	111-41355	DLM-5400N-6 DLD-5430N-7
KHS12-SPUNS  7.94 φ	SINGER (勝家)	544784	591C, D, E, 1591D, 691D
KHS12-SPW  7.94 φ WONDER HOOK (奥得旋梭) FOR THREAD TRIMMER (自動糸切)			
KHS14-G  8.10 φ	UNION SPECIAL (於仁)	61407B	61300, 61400, 61900, 63400, 63900



ROTARY HOOK HIGH SPEED TYPE : KHS

KOBAN NO	MAKER	PART NO	MACHINE
KHS14-GN  8.10 φ WITH TEFLON BASE (特氟隆内面)	UNION SPECIAL (於仁)	61407BTS	61300, 61400, 61900, 63400, 63900
KHS14-S  8.10 φ KHS14-R 8.10 φ R TYPE GIB (並模压板 R 型)	UNION SPECIAL (於仁)	61407BFG	61300, 61400, 61900, 63400, 63900
KHS14-SS  8.10 φ	UNION SPECIAL (於仁)	61407BSN	61300, 61400, 61900, 63400, 63900
KHS271-S  7.24 φ	DURKOPP ADLER (杜克普 / 愛華)	271751 LESS BC	271
KHS438  7.24 φ	PF AFF (百福)	91-168883-91W/O BC	437-739

ROTARY HOOK HIGH SPEED TYPE : KHS



KOBAN NO	MAKER	PART NO	MACHINE
KHS480  7.24 φ	PFAFF (百福)	91-171820-91W/0 BC	461-469 481-489

ROTARY HOOK LARGE TYPE : KHS20

KOBAN NO	MAKER	PART NO	MACHINE
KHS20-GTB  7.94 φ	JUKI (重机)	B1830-201-0A0	DDL-5600L, NL, NR, NU, R
	BROTHER (兄弟)	147789-901	DB2-B745-5, -B746-5, -8, SL-746A-5
	SUNSTAR (日星)		KM-146BL, -340BL, -380BL
	GOLDEN WHEEL (金輪)		CS-6103, 6104
	TYPICAL WANPING (莞坪)		B727, GC0302
KHS20-GTMP  7.94 φ	MITSUBISHI (三菱)	MF45A0120	LS2-180
	HIGHLEAD (海菱)		GC0398-1D, 0518-B-D, 128-B-D3
KHS20-GTVG  7.94 φ	SEIKO (精工)	17520	HC-28L, HCLH-28L, LSC-88L
	TYPICAL WANPING (莞坪)		TW3-S336VB
KHS20-HPEW  7.94 φ WONDER HOOK (萬得搜梭)	JUKI (重机)	B1830241HA0	DNU-241H, -261H, DSC-246, -246V
	YAKUMO (八云)	110017000	280L, 381L, 880LM
	GOLDEN WHEEL (金輪)		CS-8113, 8713, 8713 (V)
	SUNSTAR (日星)		KM-590BL
	CHIKON (奇鋼)		CK-1541, 1541-25
	BEYOUNG (本佳)		BM-246 V
	FENG YING (鋒穎)		FY-241, -246, -246V
	NITAKA (日高)		TTC-3750L, YU-380L
	SIRUBA (塞林)		UF918







ROTARY HOOK LARGE TYPE : KHS20

KOBAN NO	MAKER	PART NO	MACHINE	
KHS20-R  7.94 φ	GOLDEN WHEEL (金輪)		CS-350L, 3811, 6100, 6102, 6103, 6104 CS-6120, 6130, 6132, 6310	
	JUMBO KING(象王)		WR-3750, 3811, 5705	
	NITAKA (日高)		DY-350, 3810, 3811L, 3812L, 370L DY-3300, 350L, 3810 TC-1530, 2530 TC-3370, 3810, TDY-3811L, 3812L, TTC-3750	
		FANG HUNG (PLATINA)		TJ-3300
		FLYINGMAN(飛人)		GC20601, KDD-5570HB
		GEMSY (宝石)		7-18A
	JACK (杰克)		JK6318	
	JANOME (真善美)		DB-J706S	
	MILLION SPEICAL (萬特)		MS-370L, 3811L	
	SIRUBA (高林)		YF619	
	TAKING (天王星)		TK-335LB, 335NLB	
	YULUN (友倫)		YLM-340, 350-22	
	KHS20-R1E  7.94 φ	SEIKO (精工)	19082	HCL-2BL
	KHS20-R2E 7.94 φ FOR THICK THREAD (太糸用)			
	KHS20-RM2  7.94 φ	MITSUBISHI (三菱)	MF25B0120	DB-130-22 DY-350-22, CU-865-22FP LS2-1130-B0B, -H0B, -1280-B1T LS2-1130-B, -130-B0B
GOLDEN WHEEL (金輪)			CS-5150L	
JUMBO KING(象王)			WR-3750	
UNICORN (神馬)			DY-H340, LS2-H540 DB2-H312, H510XH, H515XH	
		HIGHLEAD (海菱)		GC0318-1, 0360-1, 0388, 0398, 0518-B GC0618-1, 128-B, 188-B, 2358-1, 6-28-1B
BEYOUNG (本像)			BM-0318-1, DB-J806	
SIRUBA (高林)			L819-X2, YF616-X2, 619-X2	
SUNSTAR (日星)			KM-640BL	
TYPICAL (標準)			GC6-9	
ZOJE (中徑)			ZJ8500H	









ROTARY HOOK LARGE TYPE : KHS20

KOBAN NO	MAKER	PART NO	MACHINE
KHS20-RM3  7.94 φ	JUKI (重机)	B1830141HA0	DU-141NH, -590
	YAKUMO (八云)		171L, 580L, DBU-175L, -180L-2 DSN-178L-3, -80L
	SEIKO (精工)	18849	H-2BL
	CONSEW (康秀)		205RB
KHS20-RMP  7.94 φ	MITSUBISHI (三菱)	MG44B0120	DY-349-22BZ, -359-22BZ, -340-22 PLK-1210, 1410, -E2010R, -E2516R LY2-3300-80B, LY3-6840-80T
	BROTHER (兄弟)	S35595-901	BAS-412, 416, 423, DB2-B742-307
	GOLDEN WHEEL (金輪)		CS-350L-T, -5150L-BT, 6103-BT, 6104-BT, 6130-BT
	JUMBO KING (象王)		WR-3750T
	HIGHLEAD (海菱)		GC0388-D
	SUNSTAR (日星)		SPS/C-5050, KM-640BL-7
	TYPICAL (標準)		GC6-5, 6-6, 6-7, GN2301, GN2603
	SIRUBA (高林)		YF616-X2
	UNICORN (神馬)		LS2-H5100XH, H5150XH, H5110XH, H5400
KHS20-RMPCC  7.94 φ DLC COATING (像鑽石一樣堅硬的石炭塗層) FOR THREAD TRIMMER (自動糸切)			
KHS20-RMPN  7.94 φ	JUKI (重机)	D1830141EA0	DSC-246-4, -6, -246V-4, -6 DSU-144, -4, -7, -145-4, -7
	YAKUMO (八云)		181LY, 280LY, 381LY, 680LY, 681LY DBU-181LY, 681LY DU-141H-5, -6, -7
KHS20-RMPNW  7.94 φ WONDER HOOK (萬得袋樣)	JUKI (重机)	D1830241EA0	DNU-241H, 1541-7
	YAKUMO (八云)		281LY, 281LY-B







ROTARY HOOK LARGE TYPE : KHS20

HIGH QUALITY

KOBAN NO	MAKER	PART NO	MACHINE
KHS20-RP1ECC  7.94 φ DLC COATING (像鑽石一樣堅硬的石炭塗層) FOR THICK THREAD TRIMMER (太糸、自動糸切)	GOLDEN WHEEL (金輪)	CS-6210	
KHS20-RPE  7.94 φ	GOLDEN WHEEL (金輪)	CSU-4100H	
	TYPICAL WANPING (宛坪)	GC3002CX	
KHS20-RPEM2A0  7.94 φ	SEIKO (精工)	STH SERIES	
	CONSEW (康秀)	206RB, 306RB	
	CHIKON (奇鋼)	CK-8BL, 8BL-1	
	TAKING (天王星)	TK-8BL	
	TYPICAL WANPING (宛坪)	TW1-0602	
	JUKI (重机)	B1830241SA0	DDL-201S, DNU-241HS, DSU-144N
KHS20-RPNG  7.94 φ	PFAFF (百福)	91-135660-91	KSM-200
☆ KHS20-RPO  7.94 φ	SEIKO (精工)	18033	SSH-88LD, -88LDC, STH-88L
☆ KHS20-RT  7.94 φ	JUKI (重机)	10078954	LZH-1290, -4, -7









ROTARY HOOK LARGE TYPE : KHS20

KOBAN NO	MAKER	PART NO	MACHINE
KHS20-RTB  7.94 φ	BROTHER (兄弟)	150487-901	DB2-B745-5, 7, -B746-7, -B797, -B797-5
KHS20-RY  7.94 φ FOR EMBROIDERY MACHINE (刺繍用)			
KHS20-RYN  7.94 φ WITH TEFLON BASE (特氟隆内蓋) FOR EMBROIDERY MACHINE (刺繍用)			
KHS20-RYP  7.94 φ THREAD TRIMMER (自動糸切) FOR EMBROIDERY MACHINE (刺繍用)	TAJIMA (田島) RICHPEACE (宝盛)		RPQ-ST, RPQ-E
☆ KHS20-RYPT2 7.94 φ	TAJIMA (田島)	05022007J014	TEJT, TFGN, TFKN, TFMX, TMCE, TMLH
KHS20-RYPN  7.94 φ WITH TEFLON BASE (特氟隆内蓋) THREAD TRIMMER (自動糸切) FOR EMBROIDERY MACHINE (刺繍用)	TAJIMA (田島)	MEC5050200RN	





ROTARY HOOK LARGE TYPE : KHS20

KOBAN NO	MAKER	PART NO	MACHINE
☆KHS20-RYPNT2 7.94 φ WITH TEFLON BASE (特氟隆内釜)	TAJIMA (田島)	05022010J001	
☆KHS20-RYPOET2  7.94 φ ECCENTRIC HOOK (偏心貨棧)	TAJIMA (田島)	05022005J015	TEJT, TFGN, TFKN, TFMX, TMCE, TMLH
KHS20-S  7.94 φ	YAKUMO (八云)	104507000	DSN-178L-2
	TOYOTA (豊田)	2120304-310B	D324
	CONSEW (康秀)	2120304-310B	120
KHS20-SMP  7.94 φ	BROTHER (兄弟)	S00982-901	BAS-350, -360 DB2-B741-3, -B747-5, -7 DB2-B748-307, -B748A, -B798, -B798-300 SN-7230-5, 7240-5
		TYPICAL WANPING (莞坪)	GC0302-D2
KHS20-SPEM2ANG 	TOYOTA (豊田)	2122304-310G	AD320-22
KHS20-SPNP  7.94 φ	SINGER (勝家)	239780	121C330AA, 121D330AA 369W
KHS20-ST  7.94 φ	TOYOTA (豊田)	2130104-300B	D530, D530E, D532, D533, D534
	CONSEW (康秀)	2130104-300B	175
	GOLDEN WHEEL (金輪)		CS-3211





ROTARY HOOK LARGE TYPE : KHS20

回転フック







KOBAN NO	MAKER	PART NO	MACHINE
KHS20-TZ  7.24 φ	STAGER (津久井)		SZ-21-1BN, -3BNL, -3NL, -4BNL, -4NL, -5
	CONSEW (康秀)	712	146RB, 148RBL
	GOLDEN WHEEL (金輪)		CS-2160, 2161, 2162
KHS20-TZNPNG 7.24 φ 17mm SLOT (針窓)	GOLDEN WHEEL (金輪)		CS-2160
	WITH NEEDLE GUARD (附針受)		
KHS30-RPNG  7.94 φ 3 TIMES LARGE (3倍)	BROTHER (兄弟)	S00688-901	LK3-B484

ROTARY HOOK LOW SPEED TYPE : KR

KOBAN NO	MAKER	PART NO	MACHINE
KR134  7.24 φ	PFAFF (百福)	91-009245-91W/0 BC	133, 134
KR134Z  7.24 φ	ZSK		J, L, M, T, X SERIES
KR134ZICC  7.24 φ HOOK BASE DLC COATING (像鑽石一樣堅硬的石炭塗層內蓋)	ZSK		J, L, M, T, X SERIES









ROTARY HOOK LOW SPEED TYPE : KR

KOBAN NO	MAKER	PART NO	MACHINE
KR134ZVICC  7.24 φ HOOK BASE DLC COATING (像鑽石一樣堅硬的石炭塗層內面)	ZSK		J, L, M, T, X SERIES
KR16-PFA  7.24 φ FOR HOUSEHOLD SEWING MACHINE (家庭用)	PF AFF (百福)		
KR18  7.94 φ	SINGER (勝家)	546794	188U
KR21-G  7.24 φ	SINGER (勝家)	127119	95-40
	JANOME (真善美)	761-510-008	TA-J761, 763, 766
KR21-GTPDE  7.24 φ	YAKUMO (八云)	109068030	380, 380B, 380Y
	SUNSTAR (日星)		KM-380, -380-B
KR21-R  7.24 φ	BROTHER (兄弟)	111272-901	DB1-8760-5, DB2-8767, -5
	YAKUMO (八云)	103109010	DBU-180-2, DSN-80-3
	GOLDEN WHEEL (金輪)		CS-350
	MITSUBISHI (三菱)	MF6580120	CU-865-12
	SINGER (勝家)	127119	95-40/96-40



ROTARY HOOK LOW SPEED TYPE : KR

HOOK SYSTEM

KOBAN NO	MAKER	PART NO	MACHINE
KR21-RD  7.24 φ	MITSUBISHI (三菱)	MN30A0120	DN-350-12
KR21-RPDE  7.24 φ	YAKUMO (八云)	109068010	380, 380B, 380Y
KR21-S  7.24 φ	JUKI (重机)	B18300090A0	DDL-115, TL-72, -82, TR-72
	MITSUBISHI (三菱)	MF60A0120	DB-320-10, LX2-371-M0
	YAKUMO (八云)	103109020	DBE-780, -N63, DBU-175, -180, -750, -780, -N70 DSN-78, -80-2
	SINGER (胜家)	127119FG	95-40
	GOLDEN WHEEL (金輪)		CS-3800, -8000-20, -8000-25, -8000-30
	DURKOPP ADLER (杜克普 / 爱华)	204695 096-15-281-4	206, 207, 270 96
	FEIYUE (费理)		GC1-5, -6
	NECCHI (尼奇)	522514	800, 801, 803, 810, 813, RM, RVG, RVM, UAN-1501
KR23-16  7.24 φ	JUKI (重机)	B18300270A0	LZ-271
	BROTHER (兄弟)	117677-901	LE2-8861-1
	CONSEW (康秀)	279	722, 825
	DURKOPP ADLER (杜克普 / 爱华)	199-15-281-4	199, 289, 489
	NECCHI (尼奇)		533, 535, 720, 721, 840
KR234  7.24 φ	PFAFF (百福)	91-063090-91W/0 BC	234 A, B (S, L)
KR238  7.24 φ	PFAFF (百福)	91-064662-91W/0 BC	130, 138, 230, 234, 238
	TAKING (天王星)		TK-735, 735N
	TYPICAL WANPING (宛坪)		TW3-P335



ROTARY HOOK LOW SPEED TYPE : KR

HIGH VIBATOR

KOBAN NO	MAKER	PART NO	MACHINE
KR238-14  7.24 φ 14mm SLOT (針窓)	PFAFF (百福)	91-064662-91W/0 BC	130, 138, 238
KR24  7.24 φ	BROTHER (兄弟)	117677-901	LE2-B861-1
	SUNSTAR (日星)		KLZ-371
	UNICORN (神馬)		LZ2-H272
	TYPICAL (標準)		GG1-1, -2
	MEIJA (美佳)		G15-2
	FEIYUE (飛躍)		GC28-1, -2, -3, GC29-1, GG30
	FLYINGMAN (飛人)		GG0802
	NECCHI (尼奇)		533, 535, 720, 721, 840
KR24-B  7.24 φ	BROTHER (兄弟)	112041-901	BAS-400, LE2-B861-7, TZ1-B651, -B652
	GOLDEN WHEEL (金輪)		CS-335BH, 335U, 8703, 8703V
	JUMBO KING (象王)		WR-335A, 652
	KING'S (王品)		HC-335
	TAKING (天王星)		TK-335, 335N, 652
	BEYOUNG (本佳)		BM-335BH, 652
	FANG HUNG (PLATINA)		TJ-335, 335H-BH, 652
	MILION SPEICAL (萬特)		MS-335, 335N, 652, B652
	UNICORN (神馬)		TZ1-B652
YULUN (友倫)		YLM-335	
KR24-RHPD  7.24 φ	JUMBO KING (象王)		WR-335A, -335B WR-3358B, -3358BL
KR24-T  7.24 φ	STAGER (澤久井)		SE-12, SZ-21, -21-1N, -21-2, -21-3N, -21-4N SZ-21-6N, -21-7N, -21-8N, -25, -72
	CONSEW (康秀)	279	133A
	GOLDEN WHEEL (金輪)		CS-2110





ROTARY HOOK LOW SPEED TYPE : KR

KOBAN NO	MAKER	PART NO	MACHINE
KR24-U  7.24 φ	SINGER (勝家)	541968	20U23
KR24U-31  7.24 φ	SINGER (勝家)	410019	20U31, 20U34
KR24U-42  7.24 φ	SINGER (勝家)	410054	20U142, 20U143, 20U42
	GOLDEN WHEEL (金輪)		CS-2180
	GEMSY (寶石)		20U23/123T, 20U33/43, 20U42
	MILLION SPEICAL (萬特)		MS-20U, 20U143
	PROTEX (通宇)		GG20U
	ZOJE (中捷)		GG20U142, 20U143, 20U23, 20U33, 20U42, 20U43 GG20U53, 20U63 ZJ20U23, 20U333, 20U43, 20U53, 20U63
KR335-V	PFAFF (百福)	91-060581-91	335G
KR69  7.24 φ	DURKOPP ADLER (杜克普 / 愛華)	69-00-581-4W/O BC	69-373
	TAKING (天王星)		TK-335, -335N
KR69-V  7.24 φ	SEIKO (精工)	17033	LSC-8B, -8BHC, -8BV
	CONSEW (康秀)		277R, 277RFS
	GOLDEN WHEEL (金輪)		CS-2280, 8750
	TYPICAL WANPING (範坪)		TW3-335, 335V
KR69-VP  7.24 φ FOR THREAD TRIMMER (自動糸切)	SEIKO (精工)	18982C	HC-2B



ROTARY HOOK VERTICAL TYPE : KRP







DISCONTINUED

KOBAN NO	MAKER	PART NO	MACHINE
KRP108-R  6.35 φ	SINGER (勝家)	224750	108U20
		244088	108U30
	DURKOPP ADLER (杜克普 / 愛華)	460243	460
KRP21  7.93 φ	JUKI (重机)	B18304050A0	LZ-405, -405-2, -407
	SINGER (勝家)	224325	107W100
KRP3114  7.94 φ	PF AFF (百福)	91-008250-91W/0.9C	114, 115, 116, 3114, 3115
KRP3116  7.94 φ	PF AFF (百福)	91-120710-91W/0.9C	3116
KRP41-B  7.93 φ	BROTHER (兄弟)	141307-901	LH4-8814, -2, -3, -4
KRP41-LH  7.93 φ	JUKI (重机)	B18087610AB	LBH-761 SERIES
	HUANAN (華南)		G16, G16-1
	PEMAL (良機)		PM-780
	SHANGGONG (上工)		G15
KRP41-LH2  7.93 φ	JUKI (重机)		LBH-771, -781
	GOLDEN WHEEL (金輪)		CS-7800, CSH-7800
	DALIAN (大連)		G18
	JACK (杰克)		JK781
	SHANGGONG (上工)		GF108
	TAKING (天王星)		TK-888, 888VB







ROTARY HOOK VERTICAL TYPE : KRP

HORIZONTAL

KOBAN NO	MAKER	PART NO	MACHINE
KRP41-R  7.93 φ	BROTHER (兄弟)	180038-901	DL1-B812, -B813, LZ1-B851
	SINGER (勝家)	210533H	107W
KRP41-S  7.93 φ	DURKOPP ADLER (杜克普 / 愛華)	098-15-007-4W/08C	252, 253, 255, 264, 91, 98
	SINGER (勝家)	210533	107W
	PEGASUS (飛馬)	179077000009	DPS-2, -3, -4
	SUNSTAR (日星)		DPK-2
	YAMATO (大和)		DP-2, -3
KRP457  7.94 φ	TOYOTA (豐田)	2130504-310	AD550, 551, 552, 553
	SINGER (勝家)	417664	457A, 457G, 457U
	BROTHER (兄弟)	S34847-901	LZ2-B852, -B853, -B854
	ZOJE (中捷)		GG457, ZJ457A/B/D, 457A125/105 ZJ457135, 457A143
	FANG HUNG (PLATINA)		TJ-457A
	FLYINGMAN (飛人)		GG302
	JACK (杰克)		JK457
	YULUN (友倫)		457A-505-PBG-NHL, 457A-525-PBG-NHL 457A-605-NCB-LG, 457A-625-NCB-LG
KRP457-W  7.94 φ	STAGER (津久井)		SZ-310
	TAKING (天王星)		TK-457A, 457G, 457U
	YULUN (友倫)		YLM-457A
	FANG HUNG (PLATINA)		TJ-457A
KRP457-W3  7.94 φ	YAMATO (大和)		LG-2000, 2125
KRP457-W3ICC  7.94 φ HOOK BASE DLC COATING (像鑽石一樣堅硬的石炭塗層內蓋)	GOLDEN WHEEL (金輪)		CS-2383



ROTARY HOOK VERTICAL TYPE : KRP

KOBAN NO	MAKER	PART NO	MACHINE
KRP457TICC 	BROTHER (兄弟)	SA1852001	ZE-855A, 8570
	GOLDEN WHEEL (金輪)		CS-2380/2383
7.94 φ HOOK BASE DLC COATING (像鑽石一樣堅硬的石炭塗層內蓋)			
☆ KRP771 	JUKI (重机)	B18087710AC	LBH-771, -781 SERIES
7.93 φ			
☆ KRP791 	JUKI (重机)	13729066	LBH-1790S, LBH-791 SERIES
7.93 φ			
KRP800 	BROTHER (兄弟)	SA1744001	HE-8000-2, 3, 5
7.93 φ			
KRP818ICC 	BROTHER (兄弟)	SA1747001	HM-8180
7.93 φ HOOK BASE DLC COATING (像鑽石一樣堅硬的石炭塗層內蓋)			











ROTARY HOOK STANDARD TYPE WITH SHAFT : KRT

KOBAN NO	MAKER	PART NO	MACHINE
KRT11-5 	JUKI (重机)	B18300550A0	LU-562, -3
	SEIKO (精工)	10655	STW-6, -7, -8BV, -8V
	SINGER (勝家)	240558	111W155, 211G155, 211U165, 211U166
	CONSEW (康秀)	10655	139, 224, 225, 226, 237, 239
9.52 φ			

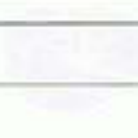

ROTARY HOOK STANDARD TYPE WITH SHAFT : KRT

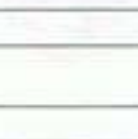

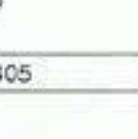
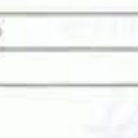
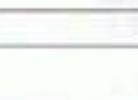

*MOD. FACTOR

KOBAN NO	MAKER	PART NO	MACHINE
KRT11-50  7.94 φ	SINGER (勝家)	240240	111W150
			
KRT11-5S  9.52 φ	SEIKO (精工)	10945	STW-26, -27, -28, -8BM, -8M
			
KRT12-4  7.94 φ	SINGER (勝家)	248463	112W140
			
KRT12-5B  9.52 φ	SEIKO (精工)	11124	LTW-26, -27, -27B, -27BM
	CONSEW (康秀)	15875	332, 332R, 332R-1, 332RK-1
	GOLDEN WHEEL (全輪)		CS-7162, -7162S
			
KRT12-5BF  9.52 φ	BROTHER (兄弟)	112691-901	LT2-B831-1, -3, -B832-1, -3, -B833
	NITAKA (日高)		TC2-B842
	SUNSTAR (日星)		KM-740
	FANG HUNG (PLATINA)		TJ-842
	SICAMA (安機)		LT2-B842
			
KRT12-5BFCI  9.52 φ	BROTHER (兄弟)	158760-901	LT2-B832-3-0, -401, -403 LT2-B835-3-0, -400, -5-0, -500 LT2-B842
	NITAKA (日高)		TC2-B842-40, TC-B842-403, -405
	MILLION SPEICAL (萬特)		MS-B842-403, MS-B842-405
	SICAMA (安機)		LT2-B842-380, -580, B849-380
	SIRUBA (高林)		T828-42, -47
	TYPICAL WANPING (莞坪)		842
	ZOJE (中捷)		842-D3
			
			
			







ROTARY HOOK STANDARD TYPE WITH SHAFT : KRT

KRT12-5BH

KOBAN NO	MAKER	PART NO	MACHINE
KRT12-5BH  9.52 φ	BROTHER (兄弟)	144903-901	LT2-B831-5, -B832-5
	GOLDEN WHEEL (金輪)		CS-3100-3, -872-3 CS-7162, -7162S
	JACK (杰克)		JK5842-5, JK5842D-3
KRT12-5BHR  9.52 φ	GOLDEN WHEEL (金輪)		CS-3100-5, -872-5, -871 CS-7162, -7162S
KRT12-5JCI  9.52 φ	JUKI (重机)	10195154	LH-1152-4, -5, -6, -7
KRT12-5JI  9.52 φ	JUKI (重机)	10197655	LH-1150, -1152
KRT12-5M  9.52 φ	MITSUBISHI (三菱)	MN10A0120	LT2-2220-MOB
	SINGER (勝家)	554507	211A, 212A141BA, 412U
	GOLDEN WHEEL (金輪)		CS-7162, 7162S
	JUMBO KING (象王)		WR-842-5
	KING'S (王品)		HC-832
	NITAKA (日高)		TC2-B842, TCC-B841, B842, B847-3, B877-3
	SICAMA (安機)		LT2-B842-3, -5, -B848-3
	TAKING (天王星)		TK-832, -842-3, -5
	UNICORN (神馬)		LT2-H320, -H321, -H620
	PEMAL (良機)		LT2-B842-3, B872
	TYPICAL (標準)		GC20201, 6220M
	BEYOUNG (本佳)		BM-842E-003, -005
	FLYINGMAN (飛人)		GC20502-4
	GEMSY (寶石)		2000-1M
	HIGHLEAD (海菱)		GC20518-B, -M
	MILLION SPEICAL (萬特)		MS-B842, -3
	KRT12-5MR 9.52 φ W/R TYPE GIB (鏡模圧板 R 型)	UNICORN (神馬)	
TYPICAL (標準)			GC202001-1



ROTARY HOOK STANDARD TYPE WITH SHAFT : KRT

KOBAN NO	MAKER	PART NO	MACHINE
KRT12-5MCI 9.52 φ	MITSUBISHI (三菱)	MN72E0120	LT2-2230-M, -M1TW
	TYPICAL (標準)		GC6220MD
	UNICORN (神馬)		LT2-H600M
KRT12-5MCI-NS 9.52 φ W/NS SPRING (耐防止空転彈簧片)	GOLDEN WHEEL (金輪)		CS-7162-BT, 7162S-BT
KRT12-5R  9.52 φ	SINGER (勝家)	240091	112W115
KRT12-5S  9.52 φ	JUKI (重机)	B18300510A0	LH-516, -518, -562A
	SINGER (勝家)	237204	112W115
KRT30JCI  9.52 φ	JUKI (重机)	22653158	LH-3128-7
KRT842CI 9.52 φ	BROTHER (兄弟)	S07427-901	LT2-B842-403, -405, -903, -905, -B847-401, -901
		SA1677-111	T-8422A, TL-847B, TN-842B
	NITAKA (日高)		TC-B842-403, -405
	SICAMA (安機)		LT2-B842-390, -580, -B848-380, -B849-380
	SUNSTAR (日星)		KM-750-7
	SIRUBA (高林)		T828-42, -47
	TYPICAL WANPING (莞坪)		TW2-B842-905
KRT842F-S  9.52 φ	BROTHER (兄弟)	S07425-901	LT2-B841-1, -3, -B842-1, -3, -B847-1
		SA1668-111	T-8420A, 8421A, TL-847A, TN-842A
	JUKI (重机)	22612055	LH-3120, -7, -3128
	SIRUBA (高林)		T828-41, -42, -47
	SUNSTAR (日星)		KM-750
	JACK (杰克)		JK5842-3
	PROTEX (适字)		TY-B842-3
	TYPICAL (標準)		GC6842M, TW2-B842, -3, GC9420M
	ZOJE (中捷)		ZJ842



ROTARY HOOK STANDARD TYPE WITH SHAFT : KRT

KOBAN NO	MAKER	PART NO	MACHINE
KRT842FV-S  9.52 φ ADJUSTABLE STRONG NEEDLE GUARD (調節針片調整旋梭)	BROTHER (兄弟)	S07425-901 SA1668-111	ADJUSTABLE STRONG NEEDLE GUARD LT2-B841-1, -3, -B842-1, -3, -B847-1 T-8421A, TL-847A, TN-842A
	JUKI (重机)	22612055	LH-3120, -7, -3128
	SIRUBA (高林)		T828-42-048-M
	SUNSTAR (日星)		KM-750
KRT842FICC-S  9.52 φ HOOK BASE DLC COATING (像鑽石一樣堅硬的石墨塗層內蓋)	BROTHER (兄弟)	S07425-901 SA1668-111	LT2-B841-1, -3, -B842-1, -3, -B847-1 T-8421A, TL-847A, TN-842A
	JUKI (重机)	22612055	LH-3120, -7, -3128
	SIRUBA (高林)		T828-42-048-M
	SUNSTAR (日星)		KM-750
KRT842H-R  9.52 φ R TYPE GIB (旋梭压板 R 型)	BROTHER (兄弟)		LT2-B841-5, -B842-5 T-8420A, 8421A, TN-842A-005
	GOLDEN WHEEL (金輪)		CS-3101-5
KRT842H-S  9.52 φ	BROTHER (兄弟)	S07426-901 SA1669-111	LT2-B841-5, -B842-5 T-8420A, 8421A, TN-842A-005
	SIRUBA (高林)		T828-41, -42
	GOLDEN WHEEL (金輪)		CS-3101
	TYPICAL (標準)		GC8842H, GC9420H
	ZOJE (中捷)		ZJ842-5
SKRT12-5-19R (KRT12-5-19R+SCP18)  9.52 φ	GOLDEN WHEEL (金輪)		CSL-1720
SKRT12-5BFC (KRT12-5BFC+SCP-8428KC) 9.52 φ	BROTHER (兄弟)	158761-901	LT2-B835-3-0, -400, -5-0, -500
	NITAKA (日高)		TC2-B845-40
	SICAMA (安機)		LT2-B845-380, -580



ROTARY HOOK STANDARD TYPE WITH SHAFT : KRT





HOOK FACTOR

KOBAN NO	MAKER	PART NO	MACHINE
SKRT12-5BK (KRT12-5BK+SCP-BK) 9.52 φ	BROTHER (兄弟)	150371-901	LT2-B835-3, -5, -800
	GOLDEN WHEEL (金輪)		CS-3150-3, -5, -875-3, -5 CS-7165
	NITAKA (日高)		TC2-B845
	CONSEW (康秀)	16291	327R-1
	FANG HUNG (PLATINA)		TJ-845
	SEIKO (精工)	16291	LTW-27BK
	SICAMA (安機)		LT2-B845
SKRT12-5J (KRT12-5J+SCP-JC) 9.52 φ	JUKI (重机)	10110104	LH-1150, -1152
SKRT12-5JC (KRT12-5JC+SCP-JC)  9.52 φ	JUKI (重机)	10110062	LH-1150-4, -5, -6 LH-1152-4, -5, -6, -7
SKRT12-5JK-L1 (KRT12-5JK-L+SCP-JKC) 9.52 φ LEFT (左)	JUKI (重机)	10207967	LH-1160, -1162
SKRT12-5JK-R1 (KRT12-5JK-R+SCP-JKC) 9.52 φ RIGHT (右)	JUKI (重机)	10208064	LH-1160, 1162
SKRT12-5JKC-L1 (KRT12-5JKC-L+SCP-JKC) 9.52 φ LEFT (左)	JUKI (重机)	10207769	LH-1160-4, -5, -6 LH-1162-4, -5, -7
SKRT12-5JKC-R1 (KRT12-5JKC-R+SCP-JKC) 9.52 φ RIGHT (右)	JUKI (重机)	10207868	LH-1160-4, -5, -6 LH-1162-4, -5, -7
SKRT12-5MC-1 (KRT12-5MC+SCP-MC) 9.52 φ	TYPICAL (標準)		GC6240MD2
	UNICORN (神馬)		LT2-H6250 (M)
	mitsubishi (三菱)	MN60E0120	LT2-2250-M1TW
SKRT12-5MC-2 (KRT12-5MC+SCP-MKC) 9.52 φ	HIGHLEAD (海菱)		GC20528-M-D3, GC20818-MD
	mitsubishi (三菱)	MN50E0120	LX2-630-M1
	TYPICAL (標準)		GC6240MD



ROTARY HOOK STANDARD TYPE WITH SHAFT : KRT

KOBAN HOOK

KOBAN NO	MAKER	PART NO	MACHINE
SKRT12-5MK (KRT12-5MK+SCP-MK)  9.52 φ	mitsubishi (三菱)	MN25A0120	LT2-2240-MOB
	SINGER (勝家)	281081	212A143
	GOLDEN WHEEL (金輪)		CS-7165, 7165S, CSL-1720
	SICAMA (安機)		LT2-B845-3, -5
	TAKING (天王星)		TK-845-3, -5
	UNICORN (神馬)		LT2-H240-MOB, H625M
	TYPICAL (標準)		GC6240M
	GEMSY (寶石)		2000-2M
	HIGHLEAD (海菱)		GC20528-M
	MILLION SPEICAL (萬特)		MS-B845, -3, -5
SKRT12-5MKH-R (KRT12-5MKH-R+SCP-MKH) 9.52 φ HEAVY MATERIAL (厚物用)			
SKRT12-5MK3 (KRT12-5MK+SCP-MK3)  9.52 φ	NITAKA (日高)		TC2-B1883, -B845
SKRT30JKC (KRT30JC+SCP-842BK) 9.52 φ	JUKI (重机)	22693857 W/CAP	LH-3128-7, -3162-7, -3168-7
SKRT842C (KRT842KC+SCP-842BC) 9.52 φ	BROTHER (兄弟)	S13612-901	LT2-B842-403, 405, B847-401, -901
		SA1678-111	T-8422A
	TYPICAL (標準)		GC9420M/HD3
SKRT842FK-S (KRT842FK-S+SCP-842BC)  9.52 φ	BROTHER (兄弟)	S07428-901	LT2-B841-1, -3, -B847-1, T-8421A-T03
		SA1670-111	T-8421A
	JUKI (重机)	22612758	LH-3128
	HUANAN (華南)		GC20505-1
	SIRUBA (高林)		T828-41, -42, -47
SKRT845BK (KRT845BK+SCP-842BK)  9.52 φ	JUKI (重机)	22688253	LH-3168
	SUNSTAR (日星)		KM-790
	BROTHER (兄弟)	S13613-901	LT2-B845-3, -5, -7, B848-1
		SA1681-111	T-8450A, TL-848A, TN-845A
	JACK (杰克)		JK5845-3
	GEMSY (寶石)		845
	SIRUBA (高林)		T828-45, -48
	TYPICAL (標準)		TW2-B845-5, GC6845
ZOJE (中捷)		ZJ845-5	

ROTARY HOOK STANDARD TYPE WITH SHAFT : KRT

KOBAN NO	MAKER	PART NO	MACHINE
SKRT845KC (KRT842KC+SCP-842BKC)	BROTHER (兄弟)	S13614-901	LT2-B845-403, -405, -407, -903, -905, -907
		SA1683-111	LT2-B848-401 T-8452A
	TYPICAL (標準)		GC9450M/HD3



9.52 φ

ROTARY HOOK LARGE TYPE WITH SHAFT : KRT

KOBAN NO	MAKER	PART NO	MACHINE
KRT-LSR	SEIKO (精工)	15040	LSW-7L, 7BL, 8BL, -8L LLW-8L, -8BL
	CONSEW (康秀)		244, 254, 255
KRT-LSRB	SEIKO (精工)	15232	LLWH-28BL-TA, LSW-28BL-TA, -68L-TA LLW-88L-TA, LLW-8L-TA
KRT-LSS	SEIKO (精工)	15502	LSW-27L, 27BL, 28BL, -28L, LLW-28L, 28BL
	CONSEW (康秀)		333, 339
KRT-LS2CI-S	SUNSTAR (日星)		KM-560-7
KRT-LS2R	BROTHER (兄弟)	150966-901	LT2-B837, -5
	NITAKA (日高)		TC-8, -8B, -28, -88, -88B, -288, -288B TC-1508, -2508
	PRINCE		PLM-100



9.52 φ



9.52 φ



9.52 φ



9.52 φ







9.52 φ



ROTARY HOOK LARGE TYPE WITH SHAFT : KRT





NOON YRATDII

KOBAN NO	MAKER	PART NO	MACHINE
KRT-LS2S  9.52 φ	BROTHER (兄弟)	153912-901	LT2-B838, -5
	TOYOTA (豊田)	2121414-310	AD331L, LP, 332L, 332LP
KRT11-5LJR  9.52 φ	JUKI (重机)	B1830563BA0	LU-563-3, 1508NH
	YAKUMO (八云)	117074005	241L, 481L, 482L
	SINGER (勝家)	412307	211U567, 212U539A, 212U839A
	GOLDEN WHEEL (金輪)		CS3L-7241, -7243
	TAKING (天王星)		TK-86
	BEYOUNG (本佳)		BM-1510, 1560
KRT11-5LJS  9.52 φ	JUKI (重机)	B18305630A0	LU-1510N, 1560N, LU-562N, LU-563N
	TAKING (天王星)		TK-86
☆ KRT11-5LLJCI-R  9.52 φ	JUKI (重机)	10353076	LU-1114-4, -5, -6, -7
KRT12-5LJH-R 9.52 φ	CHIKON (奇鋼)		CK-563, 1508, 1508-25, 1560, 1560-25
KRT12-5LM  9.52 φ	MITSUBISHI (三菱)	MN1280120	LT2-2220-80B
	GOLDEN WHEEL (金輪)		CS-3100L, -7172, -871L, -872L
	KING'S (王品)		HC-835
	NITAKA (日高)		TC2-B872, 935, TC-847-5, B841-22, 872, 877-5
	SICAMA (安模)		LT2-B872-3, -5
	BEYOUNG (本佳)		BM-872E-005
	GEMSY (宝石)		2001-1B
	MILLION SPEICAL (萬特)		MS-B842-5, B872-3, -5
	PEMAL (貞模)		LT2-B845-3, B875
	TYPICAL (標準)		GC20202, 20606, 6220B
	UNICORN (神馬)		DB2-H322/323, LS2-H620H
SUNSTAR (日星)		KM-7408L	
TAKING (天王星)		TK-872-3, -5	







ROTARY HOOK LARGE TYPE WITH SHAFT : KRT

KOBAN VECTOR

KOBAN NO	MAKER	PART NO	MACHINE	
KRT12-5LMC  9.52 φ	MITSUBISHI (三菱) HIGHLEAD (海菱) GOLDEN WHEEL (金輪) SIRUBA (高林)	MP02B0120	LU2-400-B0B LU2-420-B0B LU2-4400 LU2-4420 GC20618-1, -2, 20698-1, -2 CS3L-7241, CSU-4101 UF916-X2, 926-X2	
	GOLDEN WHEEL (金輪)		CSU-4150, -4250 CS-4150	
	KRT12-5LMC-R 9.52 φ R TYPE GIB (雙梭壓板 R 型)	GOLDEN WHEEL (金輪)		
	KRT12-5LMCV 9.52 φ ADJUSTABLE STRONG NEEDLE GUARD (鏢針片調整雙梭)			
KRT12-5LMKC-CI  9.52 φ	MITSUBISHI (三菱) GOLDEN WHEEL (金輪) UNICORN (神馬) HIGHLEAD (海菱) SIRUBA (高林)	MP43A0120	LU2-410-B1T, -430, -4410-B, -4430-B1T LU2-4412-B1T, 4650-B1T, 4710-B1T, 4730-B1T CSU-4150-BT, 4250-BT, CS-4150BT, -4250BT LT2-H6500 GC20518-B-D2, 20618-D, -2D, 20698-1D, -2D UF916-X2, UF926-X2	
	MITSUBISHI (三菱) GOLDEN WHEEL (金輪)	MP43A0120	LU2-410-B1T, -430, -4410-B, -4430-B1T CSU-4150-BT, 4250-BT	
	KRT12-5LMKC-CIV  9.52 φ ADJUSTABLE STRONG NEEDLE GUARD (鏢針片調整雙梭)	UNICORN (神馬)		LT2-H6500
	NITAKA (日高) SICAMA (安模) UNICORN (神馬)		TC2-8872-40 LT2-8872-380, 580 LT2-H6200 HEAVY	
	MITSUBISHI (三菱) TYPICAL (標準)	MN74E0120	LT2-2230-B1T GC6220BD	
KRT12-5LMKCI-NS 9.52 φ W/NS SPRING (附防止空軋彈簧片)	GOLDEN WHEEL (金輪)		CS-7172-BT	
KRT12-5LMR  9.52 φ R TYPE GIB (雙梭壓板 R 型)	UNICORN (神馬) TYPICAL (標準)		LT2-H620H GC20202-1	







ROTARY HOOK LARGE TYPE WITH SHAFT : KRT

KOBAN NO	MAKER	PART NO	MACHINE
☆KRT150LJCIV  9.52 φ ADJUSTABLE STRONG NEEDLE GUARD (調節針片調整旋梭)	JUKI (重机)	40079022	LU-15010NA-7
☆KRT2182I  9.52 φ	JUKI (重机)	10697084	LH-1178, -6 LH-2182, -6
KRT872L  9.52 φ	BROTHER (兄弟)	S09263-901 SA1685-102	LT2-8872-3, -5, TN-872A-3, -5 T-8720A-003, -005
	JUKI (重机)	22813455	LH-3178
	SIRUBA (高林)		T828-72-048-H,M
	SUNSTAR (日星)		KM-750BL
	GOLDEN WHEEL (金輪)		CS-3101-L
	TYPICAL (標準)		TW2-8872, GC6872, GC9720
	ZOJE (中捷)		ZJ872-5
	JACK (杰克)		JK5872-3
GEMSY (宝石)		872	
KRT8-LCI-S 9.52 φ	SEIKO (精工)	34314	LSW-288LC-CS, -88LC-CS
KRT8-LCI2-S 9.52 φ	SEIKO (精工)	34754	LLW-288LC/CS, -88LC/CS, LSW-88LC-CS-1
KRT8-LC-RB-CS  9.52 φ	SEIKO (精工)	34041A	LSWN-88L-A
	NITAKA (日高)		TC-28L, BL, -288L, BL, 88L, 88L, BL
KRT8-LCR-CS  9.52 φ	SEIKO (精工)	34041	LLW-88L/CS, LSWN-88L, -88LV



ROTARY HOOK LARGE TYPE WITH SHAFT : KRT



100% YKATON

KOBAN NO	MAKER	PART NO	MACHINE
KRT8-LCS-CS  9.52 φ	SEIKO (精工)	34104	LLW-28BL/CS, LLWH-28BL/CS, -8BL/CS LSWN-28BL
SKRT-BL (KRT-BL+SCP-BL)  9.52 φ	SEIKO (精工)	16407	LSW-28BLK
	CONSEW (康秀)		328RB-1
	SUNSTAR (日星)		KM-560
SKRT-BLC (KRT-BLC+SCP-BLC)  9.52 φ	SEIKO (精工)	31303	LSW-27BLC, -27BLKC, -28BLC, -28BLKC
SKRT11-5LJKR (KRT11-5LJKR+SCP-LJ)  9.52 φ	JUKI (重机)	B1830-521-HAO	LUH-521, -527, LU-1565
	YAKUMO (八云)	111066110	242L, 480L
SKRT11-5LJKS (KRT11-5LJKS+SCP-LJK)  9.52 φ	JUKI (重机)	B1830-521-OAO	LH-527, LUH-526, LU-1565
SKRT11-5LLJ-L (KRT11-5LLJ-L+SCP-LLJ) 9.52 φ LEFT (左)	JUKI (重机)	10353060	LH-1172
SKRT11-5LLJ-R (KRT11-5LLJ-R+SCP-LLJ) 9.52 φ RIGHT (右)	JUKI (重机)	10353761	LH-1172







ROTARY HOOK LARGE TYPE WITH SHAFT : KRT

HIGH SPEED

KOBAN NO	MAKER	PART NO	MACHINE
SKRT11-5LLJC-L (KRT11-5LLJC-L+SCP-LLJ) 9.52 φ LEFT (左)	JUKI (重机)	10353167	LH-1172-4, -5, -6
SKRT11-5LLJC-R (KRT11-5LLJC-R+SCP-LLJ) 9.52 φ RIGHT (右)	JUKI (重机)	10353068	LH-1172-4, -5, -6
SKRT12-5LBK2 (KRT12-5LBK2+SCP-LMKC2)  9.52 φ	BROTHER (兄弟)	155466-901	LT2-8836,-3
SKRT12-5LJKC-L1 (KRT12-5LJKC-L+SCP-LJKC) 9.52 φ LEFT (左)	JUKI (重机)	10231066	LH-1180-4, -5, -6 LH-1182-4, -5, -6
SKRT12-5LJKC-R1 (KRT12-5LJKC-R+SCP-LJKC) 9.52 φ RIGHT (右)	JUKI (重机)	10231165	LH-1180-4, -5, -6 LH-1182-4, -5, -6
☆ SKRT12-5LJK2-L1 (KRT12-5LJK2-L+SCP-LJKC) 9.52 φ LEFT (左)	JUKI (重机) SHANGGONG(上工)	10232965	LH-1180, -1182 GD8-1, -4, -7
☆ SKRT12-5LJK2-R1 (KRT12-5LJK2-R+SCP-LJKC) 9.52 φ RIGHT (右)	JUKI (重机) SHANGGONG(上工)	10233062	LH-1180, -1182 GD8-1, -4, -7
SKRT12-5LMK (KRT12-5LMK+SCP-LMK)  9.52 φ	MITSUBISHI(三菱) GOLDEN WHEEL (金輪) NITAKA (日高) SICAMA (安模) TAKING (天王星) UNICORN (神馬) HIGHLEAD (海菱) TYPICAL (標準) GEMSY (宝石) MILLION SPEICAL (萬特)	MN2680120	LT2-2240-BOB, PLY-501F CS-7175, 875L TC2-B1885 LT2-B875-3, -5 TK-875-3, -5 LT2-H240-BOB, H625H GC20518-B, 20528-B, 20638, HLY-18B GC6240B 2000-2B MS-8875-5
SKRT12-5LMKH (KRT12-5LMKH+SCP-LMKH) HEAVY MATERIAL (厚物用)			





ROTARY HOOK LARGE TYPE WITH SHAFT : KRT

KOBAN NO	MAKER	PART NO	MACHINE
SKRT12-5LMKC-C (KRT12-5LMKC-C+SCP-LMC)	MITSUBISHI (三菱) SIRUBA (高林)	MN52E0120	LU2-430-B1T, 4410-B1T, PLY-7206 UF916-X2L, 926-X2L
9.52 φ			
SKRT12-5LMKC-1 (KRT12-5LMKC+SCP-LMKC)	HIGHLEAD (海菱) MITSUBISHI (三菱) SICAMA (安機)	MN62E0120	GC20528-B-D2, GC20639-D LT2-2250-B1T LT2-8875-380, -580
			
9.52 φ			
SKRT12-5LMKC-NS (KRT12-5LMKC-NS+SCP-LMKC)	GOLDEN WHEEL (金輪)		CS-71758T, -7175H-BT, CS-81758T
9.52 φ W/NS SPRING (増勢止空転彈簧片)			
SKRT12-5LMKC-2 (KRT12-5LMKC+SCP-LMC)	MITSUBISHI (三菱)	MN62E0120	PLK-E7191, -E7194, -E7203 PLY-1185 PLY-7181, -7182, -7191, -7194, -7202, -7203 PLY-7206E
			
9.52 φ			
SKRT12-5LMK2 (KRT12-5LMK+SCP-LMKC2)	NITAKA (日高)		TC2-8875
			
9.52 φ			
☆ SKRT2172F (KRT2172F+SCP2172)	JUKI (重机)	10612752 W/CAP	LH-2172, -6
9.52 φ			
☆ SKRT2182 (KRT2182+SCP2182)	JUKI (重机)	10634756 W/CAP	LH-2182, -6
9.52 φ			
SKRT26-L (KRT26-L+SCP26-L)	SEIKO (精工) CONSEW (康秀)	15850	LSW-26BL-G, -R, LSW-6L-G, -7L-G 327RB-1
			
9.52 φ			



ROTARY HOOK LARGE TYPE WITH SHAFT : KRT

KOBAN HOOK

KOBAN NO	MAKER	PART NO	MACHINE
SKRT30LJ (KRT30LJ+SCP-LBC (J)) 9.52 φ	JUKI (重机)	22814255	LH-3178, -3188, -3188-7
SKRT30LJC (KRT30LJC+SCP-LBC (J)) 9.52 φ	JUKI (重机)	22819452	LH-3178-7
SKRT30LJK (KRT30LJ+SCP-LBKC (J)) 9.52 φ	JUKI (重机)	22827158	LH-3178, -3188
SKRT30LJKC (KRT30LJC+SCP-LBKC (J)) 9.52 φ	JUKI (重机)	22831259	LH-3178-7, -3182-7, -3188-7
			
SKRT872LC (KRT875LC+SCP-LBC) 9.52 φ	BROTHER (兄弟)	SA1689-102	LT2-8872, -403, -405, -903, -905 T-8722A-403, -405 TN-872B-403, -405
	GEMSY (宝石)		872-7
FOR THREAD TRIMMER (自動糸切用)	GOLDEN WHEEL (金輪)		CS-8173D-BT
	JACK (杰克)		JK5872-5, JK5875-5
	MILLION SPECIAL (萬特)		MS-8872-403, -405
	SIRUBA (高林)	G168-A	T828-72-□□□H/□□ T828-72-□□□M/□□
	SUNSTAR (日星)		KM-750-78L
	TYPICAL (標準)		GC6872MD3, GC9720M/HD3
	TYPICAL WANPING (莞坪)		TW2-8872-905
	ZOJE (中捷)		872-D3
SKRT875LK (KRT875LK+SCP-LBK) 9.52 φ	BROTHER (兄弟)	SA1692-102	BAS-612, 613 LT2-8875, -3, -5, -7 T-8750A-003, -005 TN-875A-003, -005
FOR CORNER STITCH (角縫)	CHURCHILL (求精)		QJ875
	DADILI (大地利)		LT2-8875-3, -5
	GEMSY (宝石)		875
	GOLDEN WHEEL (金輪)		CS-3150-L, -8176D
	JACK (杰克)		JK5875-3
	PROTEX (通宇)		TY-8875-5
	SIRUBA (高林)	G166-A	T828-75-□□□H, T828-75-□□□M, T828-75-□□□X
	SUNSTAR (日星)		KM-790BL
	TYPICAL (標準)		GC6875H, GC6875M, GC6875M
	TYPICAL WANPING (莞坪)		TW2-8875
	ZOJE (中捷)		875, ZJ875, -5

SABUN INDUSTRIAL CO., LTD.

☆ = EXCLUSIVE ITEMS

ROTARY HOOK LARGE TYPE WITH SHAFT : KRT

KOBAN NO	MAKER	PART NO	MACHINE
SKRT875LKC (KRT875LC+SCP-LBKC) 9.52 φ FOR THREAD TRIMMER (自動糸切用) & CORNER STITCH (角縫)	BROTHER (兄弟)	SA1694-102	BAS-6150, 6200 LT2-B875, -403, -405, -407, -903, -905 T-8752A-403, -405
	GEMSY (宝石)		875-7
	MILLION SPECIAL (萬特)		MS-B875-3, -403, -405
	SICAMA (安機)		LT2-B872-580
	SIRUBA (高林)	G168-A1	T828-75-□□□H / □□, T828-75-□□□M / □□, T828-75-□□□X / □□
	SUNSTAR (日星)		KM-790BL-7
	TYPICAL (標準)		GC6875HD3, GC6875MD3, GC9750M/HD3
	TYPICAL WANPING (莞坪)		875, TW2-B875-905
	ZOJE (中捷)		875-D3

ROTARY HOOK STANDARD TYPE WITHOUT SHAFT : KRT

KOBAN NO	MAKER	PART NO	MACHINE
KRT110  7.93 φ	SINGER (勝家)	237796	110W124, 21W162
KRT136M  7.93 φ	MITSUBISHI (三菱)	MV01A0120	LS5-5110, -MOB, LS2-5120, -MOB
KRT21  8.01 φ	TOYOTA (豊田)	2140114310	AD740, 740B
	SINGER (勝家)	267357	212U
	JUKI (重机)	B18305120A0	LH-512, -512-3, -515
	SHANGGONG (上工)		GC15-5-4D, GD9
KRT21-R  8.01 φ R TYPE GIB (旋梭压板 R 型)	JUKI (重机)	B18305120AH	LH-512H, -515H



ROTARY HOOK STANDARD TYPE WITHOUT SHAFT : KRT





KOBAN PRAGON

KOBAN NO	MAKER	PART NO	MACHINE
KRT211  8.01 φ	SINGER (勝家)	244711	211U
KRT22  9.52 φ	UNION SPECIA (於仁)	29474AC	61800, 62200
KRT31-11R  7.93 φ	SINGER (勝家)	238250	131W, 153W, 21W180, 46W, 52W31
KRT31-11S  7.93 φ	SEIKO (精工)	13086	CW-7B, -8B
	SINGER (勝家)	244521	131W, 47W70
	CONSEW (康秀)		207, 223, 227, 382, 388, 389
	TYPICAL WANPING (莞坪)		TW3-8B
KRT31-11SG  7.93 φ W/WASHER (附蓋可)	JUKI (重机)	B18013400A0	PLH
	SUNSTAR (日星)		KM-390
	GOLDEN WHEEL (金輪)		CS-8242
	HIGHLEAD (海菱)		GC22618, 24698-1L, -3R
KRT31-NR  7.93 φ	JUKI (重机)	21010251	PLH-981 ~ 986
	YAKUMO (八云)		981 ~ 986, PLN-985
	GOLDEN WHEEL (金輪)		CS-810, 820, 5361N, 5362N, 7361N, 7362N
	JUMBO KING (象王)		WR-810, 820
	MILLION SPEICAL (萬特)		MS-810, 820
	NITAKA (日高)		TC-810, 820, 8410, 8411, 8420, 8422, 8450 TC-9410, 9411, 9420
	SIRUBA (高林)		P717, P727
	SUNSTAR (日星)		KM-867
	BEYOUNG (本佳)		BM-810, 820
	FENG YING (鋒穎)		FY-810, 820, 985
	HIGHLEAD (海菱)		GC24018, 24518, 24818
	TYPICAL WANPING (莞坪)		GC24016, GC24080, TW5-810
	TAKING (天王星)		TK-820



ROTARY HOOK STANDARD TYPE WITHOUT SHAFT : KRT





WWW.YSM.CO.JP

KOBAN NO	MAKER	PART NO	MACHINE
KRT31-R  7.93 φ R TYPE GIB (旋梭压板 R 型)	SINGER (勝家)	236121	131W
	CONSEW (康秀)	12032	228, 229, 238, 282, 289, 357, 358, 359
	GOLDEN WHEEL (全輪)		CS-88H, 3610
	KING'S (王品)		HC-810, -815, -820, -825, -919, -929
	MILLION SPEICAL (萬特)		MS-810, -820
	JUMBO KING (象王)		WR-810, -820
	TAKING (天王星)		TK-810, -820
	BEYOUNG (本佳)		BM-1340, 88
	HUANAN (華南)		GC24010, 24011
	YULUN (友倫)		YLM-810-G, -820-G
KRT31-RG  7.93 φ W/WASHER (附華司)	SEIKO (精工)	12032	PW-68-1, -78 LPW-68, -78, -88
	YAKUMO (八云)	116072000	981, 982, 985, 986
KRT31-S  7.93 φ S TYPE GIB (旋梭压板 S 型)	SUNSTAR (日星)		KM-813, -817B, -823, -827B
KRT31-SG  7.93 φ W/WASHER (附華司)	SEIKO (精工)	12530	PW-268-1, -27B, -288 LPW-26B, -27B, -283
	UNICORN (神馬)		LT5-HP331, -HP333, PLN-27, -27B, -7, -7B
	TYPICAL WANPING (莞坪)		GC24026, TW5-820
KRT412-S  7.93 φ	SINGER (勝家)	554824	412U



ROTARY HOOK STANDARD TYPE WITHOUT SHAFT : KRT



ROTARY HOOK

KOBAN NO	MAKER	PART NO	MACHINE
SKRT136 (KRT136+SCP18) 7.93 φ	SINGER (勝家)	241691	238G
SKRT145 (KRT145+SCPF15)  7.93 φ	PFAFF (百福)	91-010850-91W/O CAP	141-146, 175-196, 871-893
SKRT151MO (KRT151MO+SCP151MO)  7.00 φ	NITAKA (日高)		TC-360-11
SKRT151R (KRT151R+SCPF15) 7.93 φ	PFAFF (百福)	91-010165-91W/O CAP	
KRT151RG (KRT151RG+SCPF15) 7.93 φ W/WASHER (附垫司)			
SKRT151S (KRT151S+SCPF15)  7.93 φ	PFAFF (百福)	91-010165-91W/O CAP	141-146, 142-720, 144-720, 175-196, 194-720 871-893
SKRT151SG (KRT151SG+SCPF15) 7.93 φ W/WASHER (附垫司)			
SKRT18-R (KRT18-R+SCP18)  7.93 φ	SINGER (勝家)	235797 W/O CAP	118W
	GOLDEN WHEEL (全精)		CS-7200
SKRT18-P (KRT18-P+SCP18-2)	SINGER (勝家)	264414	167G/W
SKRT18-S (KRT18-S+SCP18) 7.93 φ S TYPE GIB (旋梭压板 S 型)	SINGER (勝家)	235797 W/O CAP	118W



ROTARY HOOK STANDARD TYPE WITHOUT SHAFT : KRT







回転フック標準型シャフトなし : KRT

KOBAN NO	MAKER	PART NO	MACHINE
SKRT19-R (KRT19-R+SCP18)	SINGER (勝家)	247675 W/O CAP	110W2, 119W
	TREASURE (珠宝)	S60197A	HS-5500
7.93 φ R TYPE GIB (旋梭压板 R 型)			
SKRT19-S (KRT19-S+SCP18)	SINGER (勝家)	247675	110W2, 119W
7.93 φ S TYPE GIB (旋梭压板 S 型)			
SKRT190 (KRT190+SCPF19)	PFAFF (百福)	91-015023-91W/O CAP	190
	MITSUBISHI (三菱)	MQ70A120	LX5-871
	GOLDEN WHEEL (金輪)		CS-3610
			
7.93 φ			
SKRT190G (KRT190G+SCPF19)	MITSUBISHI (三菱)	MQ70A120	LX5-871
7.93 φ W/WASHER (附垫司)			
SKRT191 (KRT191+SCPF15)	PFAFF (百福)	91-010896-91	141~146, 175-196, 671-893
			
7.93 φ			
SKRT21-K (KRT21-K+SCP-MK)	JUKI (重机)	B18305280A0	LH-528
	SINGER (勝家)	412433 W/O CAP	212U
8.01 φ			
SKRT236 (KRT236+SCP18)	SINGER (勝家)	263464 W/O CAP	236G, 236W
7.93 φ			
SKRT31-SKG (KRT31-SKG+SCP31-K)	SEIKO (精工)	12856	LPW-27BK, -28BK
	SUNSTAR (日星)		KM-890
7.93 φ			
SKRT31MIN (KRT31MIN+SCP31MIN)	GOLDEN WHEEL (金輪)		CS-8369S, 8369M
			
7.93 φ MINI SIZE (迷你尺寸)			
SKRT345G (KRT345G+SCPF15)	PFAFF (百福)	91-014192-91	353-354 341-347
7.93 φ W/WASHER (附垫司)			





ROTARY HOOK STANDARD TYPE WITHOUT SHAFT : KRT

ROCK VIBRATOR

KOBAN NO	MAKER	PART NO	MACHINE
SKRT390-HBG (KRT390-HBG+SCPF15H)	GOLDEN WHEEL (金輪)	CS-8365, 8366, 8367, 8368 CS-8900, 8901, 8902	
			
7.93 φ W/WASHER (附華司)			
SKRT390 (KRT390+SCPF19)	PFAFF (百福)	390	
			
7.93 φ			
SKRT391 (KRT391+SCPF15H)	NITAKA (日高)	TC-360, 8360, 8361, 8367, 8855, 8856, 8865 TC-8866, 9255, 9256, 9365, 9366	
7.93 φ	TAKING (天王星)	TK-1247SHL, SHR, 1248HB	
SKRT47MIN (KRT470MIN+SCP31MIN)	JUMBO KING(象王)	998 (S)	CS-998-CS, DS
			
7.93 φ MINI SIZE (迷你尺寸)			
SKRT470-O-R (KRT470-O-R+SCPF15)	PFAFF (百福)	91-118875-91	441-448, 451-457
7.93 φ R TYPE GIB (旋梭压板 R 型)	GOLDEN WHEEL (金輪)		CS-2401-T
SKRT470-O-S (KRT470-O-S+SCPF15)	PFAFF (百福)	91-118876-91	441-448, 451-457
7.93 φ S TYPE GIB (旋梭压板 S 型)			





ROTARY HOOK STANDARD TYPE WITHOUT SHAFT : KRT

KOBAN NO	MAKER	PART NO	MACHINE
SKRT470-R (KRT470-R+SCPF15)  7.93 φ R TYPE GIB (旋梭压板 R 型)	SEIKO (精工)	37256	PWB-8GW-1
	JUKI (重机)	10522852	PLW-1246
	PFAFF (百福)	91-119767-91W/O CAP	471-493, 471-493
	GOLDEN WHEEL (金輪)		CS-861, 862, 8810, 8820, 8369 CSR-2401, 2401H
	JUMBO KING (象王)	991-244	WR-9910-B, BT, 9920-B, BT, 981M, N, 982, M, N, WR-991, 992, 9910-1, 9918-1, 9920-1WR-998-A, 998-B, 998-C, 998-D
	NITAKA (日高)		TC-881, 882
	TYPICAL WANPING (莞坪)		GC24660, 24680, PWB-8GW, TWB-22GW
	BEYOUNG (本佳)		BM-9910, 9920
	HIGHLEAD (海菱)		GC24618, 24618-1
	HUANAN (蕙南)		GC24301-2
	KING'S (王品)		HC-471, -474, -491
	MILLION SPEICAL (萬特)		MS-474-500, 491-800, 674-500, 691-800
	SIRUBA (高林)		R718, R728
	SUNSTAR (日星)		KM-857, -7, KM-957
	TAKING (天王星)		TK-591, 591B, 591BF, 592, 592B, 592BF TK-691, 691B, 691BF, 692, 692B, 692BF TK-991, 992
YULUN (友倫)		YLM-572W, -671W	
SKRT470-S (KRT470-S+SCPF15) 7.93 φ S TYPE GIB (旋梭压板 S 型)	SEIKO (精工)	37255	PWB-22GW-1, -8W
	YAKUMO (八云)	116728000	561 ~ 564
	PFAFF (百福)	91-119386-91W/O CAP	471-493
SKRT470-RH (KRT470-RH+SCPF15H)  7.93 φ FOR THICK THREAD (太糸用)	SEIKO (精工)	14175	LHPW-8B-1
	GOLDEN WHEEL (金輪)		CS-8360, 8361
	JUMBO KING (象王)		WR-9910-H, 9920-H
SKRT470-RHB (KRT470-RHB+SCPF15H) 7.93 φ FOR SUPER THICK THREAD (超太糸用)	GOLDEN WHEEL (金輪)		CS-8810H, -8820H
SKRT470-RHH (KRT470-RH+SCPF441H)  7.93 φ	SIRUBA (高林)	G153-A	R718-01H R728-□□H
	JUMBO KING (象王)		WR-9910-H, -9920-H













ROTARY HOOK STANDARD TYPE WITHOUT SHAFT : KRT

KOBAN NO	MAKER	PART NO	MACHINE	
SKRT470C-R (KRT470C-R+SCPF441)  7.93 φ R TYPE GIB (旋梭压板 R 型)	GOLDEN WHEEL (金輪)		CS-6111B, 6111BT, 6111T, 6112T, 6112BFT CS-6112B, 6112BT, 6112T	
	JUMBO KING (象王)		WR-991T, 992T, 9910-DMT, 9920-DMT	
	MILLION SPEICAL (萬特)		MS-474-510, 474-530P, 491-810, 491-830, 491-830P MS-674-510, 674-530P, 691-810, 691-830, 691-830P	
	SIRUBA (高林)		R71B-01-13, R72B-01-13	
	SUNSTAR (日星) G155		KM-867-7, -875-7	
	UNICORN (神馬)		LT5-H7200, H7600	
	PFAFF (百福)		471-900 ~ 493-900	
	TAKING (天王星)		TK-591B, 591T, 592T, 592TB TK-691T, 691TB, 692T, 692TB	
	SKRT470C-S (KRT470C-S+SCPF441) 7.93 φ S TYPE GIB (旋梭压板 S 型)	SEIKO (精工)	37735	PWB-22GWC, -8GWC
		JUKI (重机)	10549855 W/CAP	PLW-1245, -4, -6, -1245-4, -6
TAKING (天王星)			TK-591T, -592T, -691T, -692T	
UNICORN (神馬)			LT5-HP331AT, -HP333AT	
SKRT470CK-R (KRT470CK-R+SCP470CK) 7.93 φ	SUNSTAR (日星)		KM-890-7	
SKRT470C2-R (KRT470C2-R+SCPF441)  7.93 φ	JUMBO KING (象王)	991-332	WR-981-T, TS, BT, BTS, MT, MTS, NTS, MBT, MBTS, NBT WR-982-T, TS, BT, BTS, MT, MTS, NTS, MBT, MBTS, NBT	
	SKRT490-R (KRT490-R+SCPF490) 7.93 φ R TYPE GIB (旋梭压板 R 型)	PFAFF (百福)	91-116899-91W/O CAP	471-493
UNICORN (神馬)			LT5-HP331AT	
KRT490-S (KRT490-S+SCPF490) 7.93 φ	PFAFF (百福)	91-116885-91W/O CAP	471-493	
SKRT51 (KRT51+SCP18) 7.93 φ	SINGER (勝家)	241491 W/O CAP	136W, 138W, 51W, 52W	
SKRT571-S (KRT571-S+SCPF571)  7.93 φ	PFAFF (百福)		571	
	GOLDEN WHEEL (金輪)		CS-571	

ROTARY HOOK STANDARD TYPE WITHOUT SHAFT : KRT

KOBAN NO	MAKER	PART NO	MACHINE
SKRT67 (KRT67+SCP67)	DURKOPP ADLER (杜克普 / 愛華)	68-00-181-4W/0 CAP 67, 68	
			
7.93 φ			
SKRT72 (KRT72+SCP72)	SINGER (勝家)	203290	21W162, 22W, 72W12
7.93 φ			





ROTARY HOOK LARGE TYPE WITHOUT SHAFT : KRT

KOBAN NO	MAKER	PART NO	MACHINE
KRT1971 7.93 φ	JUMBO KING (象王) GOLDEN WHEEL (金輪)		WR-971T, 972T CS-8812
			
7.93 φ			
KRT211-L	SINGER (勝家)	510008	211G, 212G
			
7.93 φ			
KRT26-LPC	SEIKO (精工)	36902	LPW-27BLC
			
10.00 φ			
KRT26-LPC2 10.00 φ	SEIKO (精工)	40854	LPWN-28BLC, -8BLC
			
10.00 φ			
KRT31-LR	GOLDEN WHEEL (金輪)		CS-5371N, 5372N, 8330, 8350
			
7.93 φ			
KRT31-LTR 7.93 φ THREAD TRIMMER (自動糸切)	GOLDEN WHEEL (金輪)		CS-7363BT, CS-8330-BT
			
7.93 φ			







ROTARY HOOK LARGE TYPE WITHOUT SHAFT : KRT

FROM THE LIBRARY

KOBAN NO	MAKER	PART NO	MACHINE
KRT341-NCI-R 7.94 φ R TYPE GIB (旋梭压板 R 型)	JUKI (重机)	21435854	LS-1342-7
KRT341-NCI-S  7.94 φ S TYPE GIB (旋梭压板 S 型)	JUKI (重机)	21441753	LS-1342-7
KRT341-NHI 7.94 φ	NITAKA (日高)		TC-341-L TC-8370L, 8371L, 8372L, 8872L, 9510L, 9511L, 9520L
KRT341GI  7.94 φ W/WASHER (附罩司)	JUKI (重机)	B18303110A0	LS-311
	YAKUMO (八云)		341
	mitsubishi (三菱)		LU3-6960
KRT467  10.00 φ	DURKOPP ADLER (杜克普 / 愛華)	467-15-009-4	467, 767
	BROTHER (兄弟)	SA1429-001	LS2-B991, LT2-B892
	JUMBO KING (象王)		ER-467
	SIRUBA (高林)	G175	UF918-X2, UF928-X2
	SUNSTAR (日星)		KM-1060BL
KRT467J 10.00 φ	JUKI (重机)	40075390	LU-2210N-6, 2216N-7, 2260N-7, 2266N-7
KRT467L  10.00 φ	SEIKO (精工)	61019	BEW-28BLCS, -28BLS, -8BLCS, -8BLS
☆ KRT470LCI-R 7.93 φ	JUMBO KING (象王)	991-332-X2	WR-981-NX2TS, MX2BTSE, NX2BTSE WR-982-NX2TS, MX2BTS, NX2BTS
☆ KRT470LI-R 7.93 φ	JUMBO KING (象王)	991-244-X2	WR-981-X2, MX2, NX2, WR-982-X2, MX2, NX2
KRT467XLI-R  7.93 φ	DURKOPP ADLER (杜克普 / 愛華)	0767150334	767







ROTARY HOOK LARGE TYPE WITHOUT SHAFT : KRT

KOBAN NO	MAKER	PART NO	MACHINE
KRT768I-ICC-R 7.94 φ	DURKOPP ADLER (杜克普 / 愛華)	0768151834	DA768
	HIGHLEAD (海菱)		
KRT8-BL  7.93 φ	SEIKO (精工) SUNSTAR (日星)	13719	LCW-28BL, -88L KM-390BL
KRT8-LPR  10.00 φ R TYPE GIB (旋模压板 R 型)	SEIKO (精工)	14005	LPW-88L, LPWN-88L
KRT8-LPS  10.00 φ S TYPE GIB (旋模压板 S 型)	SEIKO (精工) HIGHLEAD (海菱)	14505	LPW-27BL, -28BL, LPWN-28BL GC24098-BL, -1L, -1R, -2, -BR, -2B
KRT867XLI-R  8.00 φ	DURKOPP ADLER (杜克普 / 愛華)	0667155634	867
SKRT1242-R (KRT1242-R+SCP545)  7.93 φ R TYPE GIB (旋模压板 R 型)	PFAFF (百福) MILLION SPEICAL (萬特) TAKING (天王星) YULUN (友倫) TYPICAL WANPING (莞坪)	91-140539-91W/O CAP	1242-720, 1242-748 MS-1245 TK-1245, 1245L, 1246, 1246L YLM-1245, -1246, -545, -546 TW1-1245
SKRT1242-S (KRT1242-S+SCP545) 7.93 φ S TYPE GIB (旋模压板 S 型)	PFAFF (百福)	91-140538-91W/O CAP	1242-720, 1242-748, 1244-720



ROTARY HOOK LARGE TYPE WITHOUT SHAFT : KRT



KOBAN YNATION

KOBAN NO	MAKER	PART NO	MACHINE
SKRT167 (KRT167+SCP167) 7.93 φ	DURKOPP ADLER (杜克普 / 愛華)	167-00-181-4W/O CAP	167, 168, 267, 268
SKRT1972 (KRT1972+SCP545C)  7.93 φ	GOLDEN WHEEL (金輪)		CS-6111LT
SKRT341-NR (KRT341-NR+SCP545)  7.94 φ R TYPE GIB (旋梭压板 R 型)	JUKI (重机)	21229752 W/CAP	LS-341N
	MITSUBISHI (三菱)		LY3-6840-BOT
	GOLDEN WHEEL (金輪)		CS-8233-NR, 8243
	NITAKA (日高)		TC-1341
	TYPICAL WANPING (莞坪)		TW3-341
SKRT341-NS (RT341-NS+SCP545) 7.94 φ S TYPE GIB (旋梭压板 S 型)	JUKI (重机)	21245154	LS-1341
SKRT341G (KRT341G+SCP545)  7.94 φ W/WASHER (附華司)	JUKI (重机)	21228051 W/CAP	LS-321
	YAKUMO (八云)		321L, 341L
	GOLDEN WHEEL (金輪)		CS-8233
	JUMBO KING (象王)		WR-341
	MILLION SPEICAL (萬特)		MS-1341
	NITAKA (日高)		TC-341, 350, 360L, 8370, 8371, 8372 TC-9510, 9511, 9520
	BEYOUNG (本佳)		BM-1341, 1341V
	FENG YING (鋒穎)		FY-341
	HIGHLEAD (海菱)		GC22618-1B
	TAKING (天王星)		TK-341, 341N
SKRT341SG (KRT341SG+SCP545) 7.94 φ W/WASHER (附華司)	JUKI (重机)	21245055 W/CAP	LS-321
			S TYPE GIB (旋梭压板 S 型)
SKRT470LC-R (KRT470LC-R+SCP545C)  7.93 φ	MILLION SPECIAL (萬特)		MS-674DL-510, MS-691DL-810

ROTARY HOOK LARGE TYPE WITHOUT SHAFT : KRT







KOBAN NO	MAKER	PART NO	MACHINE
SKRT545 (KRT545+SCP545)  7.93 φ SKRT545G (KRT545G+SCP545) 7.93 φ W/WASHER (耐摩可) SKRT545G-NS (KRT545G-NS+SCP545) 7.93 φ W/NS SPRING (附防止空転彈簧片)	PFAFF (百福) 91-018340-91W/CAP	541-546, 544-720, 551-555, 591-596, 551-553	
	TAKING (天王星)	TK-545, -546, -551	
	KING'S (王品)	HC-616, 618	
	GOLDEN WHEEL (金輪)	CS-8810G	
SKRT8-LPK (KRT8-LPK+SCP-BLP) 10.00 φ	SEIKO (精工)	14706 W/CAP	LPW-27BLK, 28BLK
SKRT8-LPK-2 (KRT8-LPK+SCP26-L) 10.00 φ	SEIKO (精工)	14119 W/CAP	LHPW-28BL, -8BL-1
	GOLDEN WHEEL (金輪)	CS-8370, 8371	

ROTARY HOOK SPECIAL TYPE : KRT

KOBAN NO	MAKER	PART NO	MACHINE
CKRT132SET  BOBBIN CASE COMPLETE OF KRT132	SINGER (勝家)	103118	
CKRT133SET  BOBBIN CASE COMPLETE OF KRT133	SINGER (勝家)	103120	



ROTARY HOOK SPECIAL TYPE : KRT

KOBAN NO	MAKER	PART NO	MACHINE
KRT132  10.3 φ	MITSUBISHI (三菱)	MG23E0121	DY-253
	SEIKO (精工)	1343C	SK-2B, -6, -6F
	SINGER (勝家)	103123	132K
	CONSEW (康秀)		SK-6, -7, -8
	DURKOPP ADLER (杜克普 / 愛華)	265-21-142	265
	GOLDEN WHEEL (金輪)		CS-6500, 6501, CSL-1800, 1801
KRT132-M 10.3 φ KRT132-MT 10.3 φ	SEIKO (精工)	1526	SKM-26, -36
	GOLDEN WHEEL (金輪)		CSL-1810
KRT132-SKZ  10.3 φ	SEIKO (精工)	1855	SKZ-6
KRT133  10.3 φ	SEIKO (精工)	2530	CK-1
	SINGER (勝家)	103120	133K
KRT14-5  9.52 φ	SINGER (勝家)	265093	144W, 145W
	DURKOPP ADLER (杜克普 / 愛華)	220-181-4	220
	HIGHLEAD (海菱)		GC20698-5, -6
KRT14-5HP  9.52 φ	JUKI (重機)	B1830-057-SAO	LG-158, -1, 57
	SINGER (勝家)	265093HP	144W, 145W
KRT14-5-O  9.52 φ	SEIKO (精工)	70140	JW-288L-20, -88L-20

ROTARY HOOK SPECIAL TYPE : KRT





KOBAN NO	MAKER	PART NO	MACHINE
KRT14-5-0-C  9.52 φ	SEIKO (精工)	95773	JW-28BLC, -8BLC
OKRT132R  HOOK RING OF KRT132	SINGER (勝家)	103016	
OKRT132SET  HOOK ONLY OF KRT132	SINGER (勝家)	103019	
OKRT133R HOOK RING OF KRT133	SINGER (勝家)	103109	

MISCELLANEOUS PARTS : KSP

KOBAN NO	MAKER	PART NO	MACHINE
KSP204 	SEIKO (精工)	28837C	CH-28, -6B, -7B, -8B, TH-6B, -8B
	DURKOPP ADLER (杜克普 / 愛華)	204-15-010-4	204, 205
	JUMBO KING (象王)		WR-204
	CONSEW (康秀)		757
KSP204H 	GOLDEN WHEEL (金輪)		CS-2040, 2050, 243, 273, 411, 461, 471, 491



MISCELLANEOUS PARTS : KSP

KOBAN NO	MAKER	PART NO	MACHINE
KSP204N 	JUKI (重机)	21041850	TNU-243, TSC-461, TSH-411, TSN-421, TSU-471 TU-243, 273
	YAKUMO (八云)		243, 411 ~ 471
	MITSUBISHI (三菱)	MB18A0120	PLK-E1008H, -E2008H
	GOLDEN WHEEL (金輪)		CS-243, 441N, 471
	JUMBO KING (象王)		WR-204-370, 205, 205-370
	TAKING (天王星)		TK-243, 441, 471
	HIGHLEAD (海菱)		GA0688-1, 2388-1, 2668-1, 2698-1
	CHIKON (奇鋼)		CK1461, 243, 273, 400, 441, 461, 471
	TYPICAL (標準)		TW3-234, 441, 471
KSP360 	GOLDEN WHEEL (金輪)		CS-530-100
KSP5934 	JADO	5934	
	CAMATRON		
LARGE SHUTTLE HOOK			
KSP7-31 	SINGER (勝家)	58669	7-31
	SEIKO (精工)	35224	SLH-28
	DURKOPP ADLER (杜克普 / 愛華)	20-195	20, 21
	CHIKON (奇鋼)		SD-767TR, SLH-28, SLH-767R, CK-767
	HIGHLEAD (海菱)		GA1398-1
	TYPICAL WANPING (莞坪)		733R
KSP7-9 	SINGER (勝家)	58525	7-9, 7-34, 7-48

CAP : SCP

KOBAN NO	MAKER	PART NO	MACHINE
SCP151MO 	NITAKA (日高)		TC-360-11







CAP : SCP

KOBAN NO	MAKER	PART NO	MACHINE
SCP167 	DURKOPP ADLER (杜克普 / 爱莱)	167-178-4	167, 168, 267, 268
SCP18 	SINGER (胜家)	241676	110W2, 118W, 119W, 236W, 238W
	GOLDEN WHEEL (全輪)		CS-7200, CSL-1720
	TREASURE (珠宝)		HS-5500
☆SCP2172 	JUKI (重机)	10612554	LH-2172, -6
☆SCP2182 	JUKI (重机)	10634657	LH-2182, -6
SCP26-L 	SEIKO (精工)	158509C	LHPW-28BL, LHPW-88L-1
	GOLDEN WHEEL (全輪)		CS-8370,8371
	CONSEW (康秀)		327RB-1
SCP31-K 	SEIKO (精工)	12856-9C	LPW-27BK, -28BK
	SUNSTAR (日星)		KM-890
SCP31MIN 	GOLDEN WHEEL (全輪)		CS-8369S, 8369SR
SCP35JKC 	JUKI (重机)		LH-3500
SCP470-CK 	SUNSTAR (日星)		KM-890-7



CAP : SCP

KOBAN NO	MAKER	PART NO	MACHINE
SCP545 	JUKI (重机)	21229358	LS-321, -341N
	MITSUBISHI (三菱)		LY3-6840-BOT
	YAKUMO (八云)	115470005	321L, 341L
	GOLDEN WHEEL (金輪)		CS-8810G, 8233, 8243
	JUMBO KING (象王)		WR-341
	KING'S (王品)		HC-616, -618
	MILLION SPEICAL (萬特)		MS-1245, -1341
	PF AFF (百福)		1241~1246, 1242-720, 1244-748, 541~546, 551~555
	TYPICAL WANPING (堯坪)		TW1-1245, TW3-341
	NITAKA (日高)		TC-341, 360, 360L, 1341, 8370, 9510, 9520
	BEYOUNG (本佳)		BM-1341, V
	FENG YING (鋒穎)		FY-341
	HIGHLEAD (海菱)		GC22618-1B
	TAKING (天王星)		TK-1245, 1245L, 1246, 1246L TK-341, 341N, 551
YULUN (友倫)		YLM-1245, -1246, -545, -546	
SCP67 	DURKOPP ADLER (杜克普 / 愛華)	068-178-4	67, 68
SCP-842BC 	BROTHER (兄弟)	S07740-001	LT2-B841-1, -3, -8842-403, -405, -903, -905 LT2-B847-1, -401, -901 T-8421A, 8422A, TN-842B
	HUANAN (華南)		GC20505-1
	SIRUBA (高林)		T828-41, -42, -47
	JUKI (重机)	22612600	LH-3128, -7, -3168-7
	NITAKA (日高)		TC2-B845-40
	TYPICAL (標準)		GC6842HD3, MD3, GC6845
SCP-842BK 	BROTHER (兄弟)	S07741001	LT2-B845-3, -5, -7, -B848-1 T-8450A-003, -005, -033, TL-848A TN-845A-003, -005
	JUKI (重机)	22688154	LH-3128-7, -3162-4, -7, -3168, -7
	SIRUBA (高林)		T828-45-048-M, T828-48
	SUNSTAR (日星)		KM-790
	GOLDEN WHEEL (金輪)		CS-3150
	GEMSY (宝石)		845
	JACK (杰克)		JK5845-3
	TYPICAL WANPING (堯坪)		TW2-B845-5, GC6845H
	ZOJE (中捷)		ZJ845-5



CAP : SCP

KOBAN NO	MAKER	PART NO	MACHINE
SCP-842BKC 	BROTHER (兄弟)	S07742-001	LT2-8845-403, -405, -407, -903, -905, -907, -8848 T-8452A-403, -405, -406, TL-848B TN-845A-003, -005
	NITAKA (日高)		TC-8845-403, -405
	SICAMA (安機)		LT2-8845-380, 580
	SUNSTAR (日星)		KM-790-7
	JACK (杰克)		JK5845-5
	PROTEX (通宇)		TY-8845-403
	TYPICAL (標準)		TW2-8845-905, GC6845HD3, MD3
	ZOJE (中捷)		845-D3
	SIRUBA (高林)		T828-54, -48
SCP-BK 	BROTHER (兄弟)	151041-001	LT2-8835-3, -5, -800
	SEIKO (精工)	16291-6C	LTW-27BK
	CONSEW (康秀)		327R-1
	GOLDEN WHEEL (金輪)		CS-3150-3, -5, -875-3, -5 CS-7165
	NITAKA (日高)		TC2-8845
	FANG HUNG (PLATINA)		TJ-845
	SICAMA (安機)		LT2-8845
	SCP-BL 	SEIKO (精工)	16407-9C
SUNSTAR (日星)			KM-560
CONSEW (康秀)			328RB-1
SCP-BLP 	SEIKO (精工)	14706-9C	LPW-27BLK, -28BLK
	GOLDEN WHEEL (金輪)		CS-8370, -8371
SCP-JC 	JUKI (重机)	10110252	LH-1150, -1152-4, -5, -6, -7
SCP-JKC 	JUKI (重机)	10208254	LH-1160-4, -5, -6, -1162-4, -5, -6











CAP : SCP

KOBAN NO	MAKER	PART NO	MACHINE
SCP-LBC 	BROTHER (兄弟)	S09278-001	LT2-B872-403, -405, -903, -905 T-8722A-403, 405, TN-872B-3, -403, -405, -5
	MILLION SPEICAL (萬特)		MS-B872-403, -405
	NITAKA (日高)		TC-B872-403, -405
	ZOJE (中捷)		872-D3
	SICAMA (安機)		LT2-B872-380, -580
	GEMSY (寶石)		872-7
	JACK (杰克)		JK5872-5, 5875-5
	TYPICAL (標準)		TW2-B872-905, GC6872MD3
	SUNSTAR (日星)		KM-750-78L
	SIRUBA (高林)		T828-72-H-U, -M-U
SCP-LBC(J) 	JUKI (重机)		LH-3178, -7, -3188, -7
SCP-LBK 	BROTHER (兄弟)	S09279-001	BAS-612, 613 LT2-B875, -3, -5, -7 T-8750A, TN-875A
	PROTEX (通宇)		TY-8875-5
	SIRUBA (高林)		T828-75-048-M
	ZOJE (中捷)		ZJ875-5
	GEMSY (寶石)		875
	JACK (杰克)		JK5875-3
	SUNSTAR (日星)		KM-790-BL
	GOLDEN WHEEL (金輪)		CS-3150-L
	TYPICAL (標準)		GC6875H, M, TW2-B875
SCP-LBKC 	BROTHER (兄弟)	S09280-001	BAS-610, -611, LS2-B883 LT2-B875-403, -405, -407, -903, -905 T-8752A-403, -405
	NITAKA (日高)		TC-B875-403, -405
	MILLION SPEICAL (萬特)		MS-B875-3, -403, -405
	TYPICAL WANPING (魏坪)		TW2-B875-905, GC6875HD3, MD3
	ZOJE (中捷)		875-D3
	SICAMA (安機)		LT2-B875-380
	SIRUBA (高林)		T828-75-H-U, -M-U, -X-U
	SUNSTAR (日星)		KM-790BL-7
	GEMSY (寶石)		875-7
	SCP-LBKC(J) 	JUKI (重机)	22827257







CAP : SCP

KOBAN NO	MAKER	PART NO	MACHINE
SCP-LJ 	JUKI (重机)	B18375210A0	LU-1565, LUH-521, -526
	YAKUMO (八云)		242L
SCP-LJK 	JUKI (重机)	B18375260A0	LH-527, LUH-521, -527
	YAKUMO (八云)		242L
	SHANGGONG (上工)		GD8-1, 8-4, 8-7
SCP-LJKC 	JUKI (重机)	10231553	LH-1180-4, -5, -6, -1182-4, -5, -6
SCP-LLJ 	JUKI (重机)	10353555	LU-1114-4, -5, -6, -7 LH-1172-4, -5, -6
SCP-LMC 	MITSUBISHI (三菱)	MN52E0125	LU2-4410-B1T PLY-7182, -7191, -7194, -7203, -7206
	SIRUBA (高林)		UF916-X2L, UF926-X2L
SCP-LMK 	MITSUBISHI (三菱)	MN26E0125	LT2-2240-BOB, PLY-501F
	GOLDEN WHEEL (金輪)		CS-3150-L, 7175, -875L
	MILLION SPEICAL (莫特)		MS-8875-5
	NITAKA (日高)		TC2-B1835, -8875
	SICAMA (安機)		LT2-8375-3, -5
	TAKING (天王星)		TK-875-3, -5
	TYPICAL (標準)		GC6240B
	GEMSY (宝石)		2000-2B
	HIGHLEAD (海菱)		GC20518-B, 20528-B, 20638, HLY-18B
	UNICORN (神馬)		LT2-H240-BOB, H625H
SCP-LMKC 	MITSUBISHI (三菱)	MN62A0125	LT2-2250-A1T, -B1T
	GOLDEN WHEEL (金輪)		CS-7175BT, 7175H-8T
	SICAMA (安機)		LT2-8875-380, -580
	HIGHLEAD (海菱)		GC20528-B-D2, 20638-D
SCP-LMKC2 	NITAKA (日高)		TC2-8875
	BROTHER (兄弟)		LT2-8836-3







CAP : SCP

KOBAN NO	MAKER	PART NO	MACHINE
SCP-MC 	MITSUBISHI(三菱)	MN50E0125	LX2-630-M1
	TYPICAL (標準)		GC6240MD2
	UNICORN (神馬)		LT2-H6250LIGHT
SCP-MK 	MITSUBISHI(三菱)	MN27A0125	LT2-2240-M0B
	GOLDEN WHEEL (金輪)		CS-7165, CSL-1720
	JUKI (重机)		LH-528
	GEMSY (宝石)		2000-2M
	HIGHLEAD (海菱)		GC20528-M
	SINGER (勝家)		212U
	TYPICAL (標準)		GC6240M, MD
	MILLION SPEICAL (萬特)		MS-8845, -3, -5
	NITAKA (日差)		TC2-B1883
	SICAMA (安規)		LT2-B845-3, -5
	TAKING (天王星)		TK-845-3, -5
UNICORN (神馬)		LT2-H240-M0B, H625M	
SCP-MK3 	NITAKA		TC2-8845, B1883
SCP-MKC 	MITSUBISHI(三菱)	MN60A0125	LT2-2250-M1TW, LX2-630-M1
	GOLDEN WHEEL (金輪)		CS-7165-BT
	HIGHLEAD (海菱)		GC20528M-D3, 20818-MD



CAP : SCP

443

KOBAN NO	MAKER	PART NO	MACHINE
SCPF15 	JUKI (重机)	10547651	PLW-1246
	YAKUMO (八云)		561 ~ 564
	SEIKO (精工)	37255-9C	PWB-22GW-1, -8GW-1
	PFAFF (百福)	91-018348-91	120, 122, 141 ~ 146, 142 ~ 721, 151, 155 175-196, 191 ~ 196, 194-720, 341-347, 353-354 441 ~ 448, 451 ~ 457, 471 ~ 493, 671 ~ 893
	GOLDEN WHEEL (金輪)		CS-861, 862, 8810, 8820, CSR-2401, 2401H CS-8369, M, MH, MHR, MR, R
	JUMBO KING (象王)		WR-991, 992, 9910-1, 9920-1 WR-998-A, 998-B, 998-C, 998-D
	KING'S (王品)		HC-471, -474, -491
	MILLION SPEICAL (萬特)		MS-474-500, 491-800, 674-500, 691-800
	TYPICAL WANPING (莞坪)		GC20616, 24660, 24680, PWB-8GW, TWB-22GW
	BEYOUNG (本佳)		BM-9910, 9920
	HUANAN (華南)		GC24301-2
	NITAKA (日高)		TC-881, 882
	SIRUBA (高林)		R718, R728
	HIGHLEAD (海菱)		GC24618
	SUNSTAR (日星)		KM-857, -7
	TAKING (天王星)		TK-591, 591B, 591BF, 592, 592B, 592BF TK-691, 691B, 691BF, 692, 692B, 692BF TK-991, 992
	YULUN (友倫)		YLM-572W, -671W
SCPF15H 	SEIKO (精工)		LHPW-8B-1
	GOLDEN WHEEL (金輪)		CS-8360, 8365, 8900, 8901, 8902 CS-8810H, 8820H
	JUMBO KING (象王)		WR-9910-H, 9920-H
	NITAKA (日高)		TC-360, 8360, 8361, 8367, 8855, 8856, 8865, 8866 TC-8255, 9256, 9365, 9366
	FOR THICK THREAD (太糸用)	TAKING (天王星)	
SCPF19 	MITSUBISHI (三菱)		LX5-871
	PFAFF (百福)		190, 390
	GOLDEN WHEEL (金輪)		CS-3610
SCPF441 	SEIKO (精工)		PWB-22GWC, -8GWC
	JUKI (重机)	10545358	PLW-1245-4, -6, -1246-4, -6
	GOLDEN WHEEL (金輪)		CS-6111B, BT, T, -6112T
	JUMBO KING (象王)		WR-991T, 992T, 9910-DMT, 9920-DMT
	MILLION SPEICAL (萬特)		MS-474-510, 474-530P, 491-810, 491-830 MS-491-830P, 674-510, 674-530P, 691-810 MS-691-830, 691-830P
	SIRUBA (高林)		R718-01-13, R728-01-13
	SUNSTAR (日星)		KM-867-7, -875-7
	TAKING (天王星)		TK-591B, 591T, 592T, 592TB TK-691T, 691TB, 692T, 692TB
	PFAFF (百福)		471-900 ~ 493-900
	UNICORN (神馬)		LT5-HP331AT, -HP333AT, LT5-H7200, H7600

SABUN INDUSTRIAL CO., LTD.

☆ = EXCLUSIVE ITEMS



CAP : SCP

SCPF571





KOBAN NO	MAKER	PART NO	MACHINE
SCPF571 	GOLDEN WHEEL (金輪)	CS-8830	

BOBBIN CASE STANDARD TYPE : SC

KOBAN NO	MAKER	PART NO	MACHINE
SC211 	DURKOPP ADLER (杜克普 / 愛華)	211275	211, 212, 213, 215
SC265 	DURKOPP ADLER (杜克普 / 愛華)		265, 266, 267, 268, 269
SC31  FOR SINGLE NEEDLE LOCK STITCHER (高速平車単針用)	JUKI (重機)	B18370120A0	DDL-5550N AND OTHER LOCK STITCHER
	BROTHER (兄弟)	100369-001	DB2-B755-5 AND OTHER LOCK STITCHER
	MITSUBISHI (三菱)	MF10E0125	LS2-1130-MOB AND OTHER LOCK STITCHER
	SINGER (勝家)	S2237	591C200AA AND OTHER LOCK STITCHER
	CONSEW (康秀)	2110104-301C	230 AND OTHER LOCK STITCHER
	GOLDEN WHEEL (金輪)		CS-5100, 5150, 5200, 6000
	FEIYUE (飛躍)		GC15, GC28
	JUMBO KING (象王)		WR-1130
	MILLION SPEICAL (萬特)		MS-735,B735R
	NITAKA (日高)		TTC-1550
SIRUBA (高林)		L818F-DM,L,M,L1818F-RM1,L818F-H,819	
TAKING (天王星)		TK-89, -H	
SC31-BNS2  W/NS SPRING (附防止空転彈簧片)	BROTHER (兄弟)	S25780-001	BAS-23, -301, -302



BOBBIN CASE STANDARD TYPE : SC

KOBAN NO	MAKER	PART NO	MACHINE
SC31-NS  W/NS SPRING (附防止空転彈簧片) FOR THREAD TRIMMER (自動糸切)	JUKI (重机)	11038759	DDL-5570N, -5580N, DLM-5400N-7 DDL-9000S, DLN-5410N-7, DLU5490N-7 DMN-5420N-6, -7
	BROTHER (兄弟)	S03245-001	DB2-B737, S-7200B
	MITSUBISHI (三菱)	MF40E0125	LS2-1180-H, -1280-M, 1380-M1T
	TOYOTA (豊田)	2110804-301B	AD1000 ~ 3000, 157, 340, 341, 345, 352
	YAKUMO (八云)	112035000	178Y-2, -3
	HIGHLEAD (海菱)		GC128, 0518
	TYPICAL (標準)		GC-8-D2
	UNICORN (神馬)		DB2-H360, LS2-H5100, 5150
	ZOJE (中捷)		ZJ5580, 8500
	SINGER (勝家)	52237NS	591
	JACK (杰克)		JK8900D
	PROTEX (通字)		TY-B211
	SHANGGONG (上工)		GC30, GC555
	KINGTEX (精模)		KL-300M-A
	GOLDEN WHEEL (金輪)		CS-5100-BT, 5150-BT, 6000-BT
	SUNSTAR (日星)		KM-250
	SIRUBA (高林)		L818F-01-03, M1-13, L1-13 L818-H1-13, L819-X1-13
SC34-1  FOR ZIGZAG MACHINE (千鳥縫用)	BEYOUNG (本佳)		BM-335BH, 652
	JUMBO KING (象王)		WR-335A, 335B, 3358B, 3358BL, 652
	TAKING (天王星)		TK-335, 335N, 652
SC34-1NS  W/NS SPRING (附防止空転彈簧片) FOR ZIGZAG MACHINE (千鳥縫用)			
SC34-2NS  W/NS SPRING (附防止空転彈簧片) FOR EMBROIDERY MACHINE (刺繡用)			



BOBBIN CASE STANDARD TYPE : SC

11/12 BOBBIN

KOBAN NO.	MAKER	PART NO.	MACHINE
SC35 	BROTHER (兄弟)	117596-001	BAS-400, LE2-B861-1
	JUKI (重机)	B1837-027-0A0	LZ-271
	GOLDEN WHEEL (金輪)		CS-335BH, 335U, 8703 (V)
	MILLION SPEICAL (萬特)		MS-20U, 335, 335N, 652
	UNICORN (神馬)		LZ2-H272, TZ1-B652
	YULUN (友倫)		YLM-335
	ZOJE (中捷)		ZJ20U, GG20U
	SUNSTAR (日星)		KLZ-371
	TYPICAL (標準)		GG1-1, 1-2
	NECCHI (尼奇)		533, 535, 720, 721, 840
	PROTEX (通字)		GG20U
	GEMSY (寶石)		20U
	KING'S (王品)		HC-335
	MEJA (美佳)		G15-2
	FANG HUNG (PLATINA)		TJ-335, 652
	FEIYUE (飛躍)		GC28, 29, 30
FLYINGMAN (飛人)		GG0802	
SC35-NS  W/NS SPRING (附防止空転彈簧片) FOR EMBROIDERY MACHINE (刺繡用)	JUKI (重机)	B18375820A0	LZ-582 ~ 586
	TAJIMA (田島)		TFGN, TPKN, TFMX, TEJT, TMLH, TMCE
	BARUDAN (百魯達)	KF221010	BEDT, BEDY, BEDS, BEDR, BEDX, ELITE
	TOYOTA (豐田)		AD830, 851
	BROTHER (兄弟)	S17096-001	LE2-B861-7
	MEJA (美佳)		GG70701
	SUNSTAR (日星)		SWF/A-T1201, UK1204, WE1218
	TYPICAL (標準)		GYD12-6, 20-6, 7-6
RICHPEACE (寶盛)		RPED, RPEB, RPMR	
SC35-T  FOR ZIGZAG MACHINE (千鳥縫用)	BROTHER (兄弟)	117596-001	TZ1-B651, 652
	STAGER (津久井)		SE-12, S221 SERIES
	CONSEW (康秀)	284	133A, 722, 825
	GOLDEN WHEEL (金輪)		CS-2110, -2180
	DURKOPP ADLER (杜克普 / 愛華)		199, 289, 489
	SINGER (勝家)		20U
	MILLION SPEICAL (萬特)		MS-20U
SC38  W/MAGNET (附磁鐵) FOR SINGLE NEEDLE LOCK STITCHER (高速平車單針用)	SINGER (勝家)	52237M	





BOBBIN CASE STANDARD TYPE : SC

KOBAN NO	MAKER	PART NO	MACHINE
SC39 	PFAFF (百福)	91-009076-91	130, 133, 134, 138, 230, 234, 238, 331-337 335, 337-734, 434, 437-439, 461-469, 481-489
	TAKING (天王星)		TK-735, 735N
	DURKOPP ADLER (杜克普 / 愛華)		69-373
SC39-14 	PFAFF (百福)		130, 138, 238, 331-337
	SEIKO (精工)	17034	LSC-8B, -8BV
	GOLDEN WHEEL (金輪)		CS-2280, 8750
	CONSEW (康秀)		277R
	TYPICAL WAMPING (莞坪)		TW3-335V, P335
SC39-14NS  W/NS SPRING (附防止空軔彈簧片)	SEIKO (精工)	17318	LSC-8BHC
SC39-34NS  W/NS SPRING (附防止空軔彈簧片)	ZSK	570649	J, L, M, T, X Series
SC39-NS  W/NS SPRING (附防止空軔彈簧片)	SEIKO (精工)		HC-2B
SC639 	UNION SPECIAL (於仁)	63913	61300, 61400, 61900, 63400, 63900
SC81 	SINGER (勝家)	275091	402W
SC81-2 	YAKUMO (八雲)	109070000	380, 380B, 380Y, 381Y
	SUNSTAR (日星)		KM-380, 380B



BOBBIN CASE STANDARD TYPE : SC

SC 4-21000138

KOBAN NO	MAKER	PART NO	MACHINE
SC81-2NS  W/NS SPRING (附防止空転彈簧片)	YAKUMO (八云)	109546000	380, 380B, 380Y, 381Y
SC81-2NS2  W/NS SPRING (附防止空転彈簧片)	JUKI (重机)	21210059	DSC-244-4, -7, -245V-4, -7
	YAKUMO (八云)	109471005	380, 380B, 380Y, 381Y
SC82 	SINGER (勝家)		281-81
	SUNSTAR (日星)		KM-530-7
SC82-J 	JUKI (重机)	B18370410A0	DLN-412-2, -4, -415H-2, 5410N
	SEIKO (精工)		H-88, H-88D
	MITSUBISHI (三菱)	MF10E0125	CU-865-12, LY3-151
	FENG YING (鋒穎)		FY-245, 245V
	HIGHLEAD (海菱)		GC0518
	HUANAN (華南)		GC0301-1, 0302
	SUNSTAR (日星)		KM-350A
TYPICAL (標準)		GC6-10, -11, GC6160	
SC82-JNS  W/NS SPRING (附防止空転彈簧片)	JUKI (重机)	D1837415DAL	DLN-412-2, -4, -415H-2
	MITSUBISHI (三菱)	MN35A0125	LS2-2210-M, -M1T, -M1TW
	TOYOTA (豐田)	2121604-301B	AD340, 340B, 341
	SUNSTAR (日星)		KM-235A, 350A-7
	ZOJE (中捷)		ZJ2628
	SHANGGONG (上工)		GC0301, 0601-1, 505-1
SC82-JNS2  W/NS SPRING (附防止空転彈簧片)	JUKI (重机)	B18372450A0	DSC-244, V, -245, V
	YAKUMO (八云)		681
	BEYOUNG (本億)		BM-244, 244V



BOBBIN CASE STANDARD TYPE : SC

KOBAN NO	MAKER	PART NO	MACHINE
SC83 	DURKOPP ADLER (杜克普 / 愛華)	89-178-C	296, 396
	UNION SPECIAL (於仁)	61413	61300, 61400, 61900, 63400, 63900

BOBBIN CASE LARGE TYPE : SC

KOBAN NO	MAKER	PART NO	MACHINE
SC31-L 	TOYOTA (豐田)	2110804-301	D324
SC33-L 	JUKI (重機)	B1837201SA0	DOL-5600J, L, NL, NR, NU, R DNU-241HS, DSU-144N, DU-141N
	BROTHER (兄弟)	147790001	DB2-B797, -5
	MITSUBISHI (三菱)	MF25E0125	DB-130-22 LS2-1130-B0B, -H0B LS2-1130-H0B, -1280-B1T
	YAKUMO (八雲)	201144000	171L, 580L, DBU-175L, -180L-2, DSN-178L-3
	BEYOUNG (本億)		BM-0318-1, DB-J806
	GOLDEN WHEEL (金輪)		CS-350L, 3811, 5150L, 6100, 6102, 6103, 6104
	JUMBO KING (象王)		WR-3750, 3811
	MILLION SPECIAL (萬特)		MS-3811L
	NITAKA (日高)		DY-350, 3810, 3811L, 3812L, 370L TC-3370, 3810, TDY-3811L, 3812L, TTC-3750
	SIRUBA (塞林)		YF619
	JACK (杰克)		JK6318
	TYPICAL WANPING (莞坪)		GC0302, 6-9
	UNICORN (神馬)		DB2-H312, H510, H515, DY-H340
	YULUN (友倫)		YLM-340, 350-22
	ZOJE (中捷)		ZJ8500H
	HIGHLEAD (海菱)		GC128, 188, 2358
	SUNSTAR (日星)		KM-146BL, 340BL, 380BL, 640BL
	TAKING (天王星)		TK-335LB, 335NLB
GOLDEN WHEEL (金輪)		CS-5150L	









BOBBIN CASE LARGE TYPE : SC

SC33-11303

KOBAN NO	MAKER	PART NO	MACHINE
SC33-LM			
			
W/MAGNET (附磁鉄)			
SC33-LB	MITSUBISHI(三菱)	MG44E0125	DY-349-22BZ, -359-22BZ
	TYPICAL (標準)		GC6-9-D2
W/NS SPRING (附防止空転彈簧片)			
SC33-LD	JUKI (重機)	B1837241H00	DNU-241H, -261H, DSC-246, -246V
	SEIKO (精工)	18099	SSH-8BLD, -8BLDC, STH-8BL
W/NS SPRING (附防止空転彈簧片)	YAKUMO (八雲)		280L, 381L, 880LM
	BEYOUNG (本佳)		BM-246, 246V
	CHIKON (奇鋼)		CK-8BL-1, STH-8BL
	FENG YING (鋒穎)		FY-241, 245, 246V
	NITAKA (日高)		TTC-3750-L, YU-380L
	CONSEW (康秀)		206RB, 306RB
	SIRUBA (高林)		UF918
	TYPICAL WANPING (莞坪)		TW1-0502, GC3002CX
	SUNSTAR (日星)		KM-590BL
	TAKING (天王星)		TK-8BL
SC33-LDH	GOLDEN WHEEL (金輪)		CS-8713, 8713V FOR THREAD TRIMMER
FOR THICK THREAD (太糸用) W/NS SPRING (附防止空転彈簧片)			
SC33-LNS	BROTHER (兄弟)	151845-001	BAS-350, -360, -412, -416, -423 DB2-B741-3, -B745-5, -7, -B746-5, -7, -8 DB2-B746A, -B747-5, -7, -B748-307, -B748A DB2-B798, -300, SL-746A-5
	MITSUBISHI(三菱)	MG44E0125	PLK-1210, -E2010R, -E2516R
W/NS SPRING	SEIKO (精工)	18850	H-2BL, HCL-2BL
	TOYOTA (豐田)		AD320-22
	CONSEW (康秀)	1144	205RB
	GOLDEN WHEEL (金輪)		CS-5150L-BT, 6103-BT, 6104-BT
	HIGHLEAD (海菱)		GC0388-D, 0398-1D, 0518-B-D
	SUNSTAR (日星)		KM640BL-7
	TYPICAL (標準)		GN2301, 2603, GC6-5, -6, -7
	JUMBO KING (象王)		WR-3750T
	SIRUBA (高林)		YF616-X2-12
	UNICORN (神馬)		LS2-H5100, H5150, H5400



BOBBIN CASE LARGE TYPE : SC

KOBAN NO	MAKER	PART NO	MACHINE
SC33-LNSH  FOR THICK THREAD (太糸用) W/NS SPRING (附防止空転彈簧片)	GOLDEN WHEEL (全輪)		CS-6210, 6220B
SC33-LNS3  W/NS SPRING (附防止空転彈簧片)	JUKI (重机) YAKUMO (八云) TYPICAL WANPING (剪坪) SEIKO (精工)	D1837141EA0 17522	DSC-246, -246V DSU-144, -4, -7, 145-4, -7 180LY-2, 181LY, 280LY, 281LY, 381LY, 680LY DBU-681LY, DNU-241H, DSN-178L-2 DU-141H-5, -6, -7 TW3-S336VB HC-2BL, HCLH-2BL, LSC-88L
SC34-L 	STAGER (津久井) CONSEW (康秀) PFAFF (百福) TOYOTA (豊田) GOLDEN WHEEL (全輪)	714 99-135658-91 2130104-301A	SZ-21-1B N, -3BNL, -3NL, -4BNL, -4NL, -5 146RB KSM-200 D530, D530E, D532, D534 CS-2160, 2161, 2162, CSZ-3211
SC34-LHNS  W/NS SPRING (附防止空転彈簧片) FOR EMBROIDERY MACHINE (刺繡用)			
SC34-LNS  W/NS SPRING (附防止空転彈簧片) FOR ZIGZAG MACHINE (千鳥縫用)			
SC34-LZNS  W/NS SPRING (附防止空転彈簧片)	JUKI (重机)	10080059	LZH-1290, -4, -7



BOBBIN CASE LARGE TYPE : SC







KOBAN NO	MAKER	PART NO	MACHINE
SC35-L  FOR ZIGZAG MACHINE (千鳥縫用)			
SC35-LNS  W/NS SPRING (耐防止空転彈簧片) FOR EMBROIDERY MACHINE (刺繡用)			
SC35-LNSG  W/NS SPRING (耐防止空転彈簧片)	SEIKO (精工)	LAH-1LC/N	
SC35-XLNS 3 TIMES LARGE (3倍) W/NS SPRING (耐防止空転彈簧片)	BROTHER (兄弟)	S00691401	KE-484C-X
SC369 	SINGER (勝家)	369W	

BOBBIN CASE SPECIAL TYPE : SC

KOBAN NO	MAKER	PART NO	MACHINE
☆ SC180J 	JUKI (重机)	B18282100A0	AMS-211, -215, -220, -222, -224 LK-1952 ~ 1954
☆ SC180JHA	JUKI (重机)	B5014224000	AMS-206, -210, -212, -220, -224, -229









BOBBIN CASE SPECIAL TYPE : SC

KOBAN NO	MAKER	PART NO	MACHINE
☆SC180JHABK 	JUKI (重机)	B1828210DAA	AMS-210D, LK-1910, -1920, 1930
☆SC180JHABKN	JUKI (重机)	B1828210DOA	AMS-210D, LK-1910, -1920, 1930
☆SC180JHBBK 	JUKI (重机)	B1828210DAC	AMS-206, -210, -212, -220, -224, -229
SC181 	MITSUBISHI(三菱)	MS17A0125	PLK-A2016, -A3530, -E1010, -E2516 PLK-E4030, -E4519, -E6019, -E6030
	SINGER (勝家)	281776	569U
	SIRUBA (基林)		PK588
SC181H 	MITSUBISHI(三菱)	MS17A1125	PLK-A2016, -A3530, -E1010, -E2516 PLK-E4030, -E4519, -E6019, -E6030
☆SC205 	JUKI (重机)	B18282050A0	AMS-205, 206, 210, 211 AMS-212, 220, 222, 223, 224
☆SC205H 	JUKI (重机)	B18282050AA	AMS-215CHS
☆SC215 	JUKI (重机)	B1828215PA0	AMS-215P









BOBBIN CASE SPECIAL TYPE : SC

SC-20000000

KOBAN NO	MAKER	PART NO	MACHINE
☆SC215HBK	JUKI (重机)	B1852210DA0	AMS-215P
			
SC430	BROTHER (兄弟)	159610101	LK3-B4300E, B430E, B435
	MITSUBISHI(三菱)	MS01A0125	PLK-03BTA, 03HS, 109, 0303, 0604, 0804, 08HSW
W/NS SPRING (附防止空転弹簧片)			
SC70-2	BROTHER (兄弟)	107097101	DL1-B812, -B813, LZ1-B851
	JUKI (重机)	B18107610A0	LBH-761 SERIES
	DURKOPP ADLER (杜克普 / 爱华)		252, 253, 254, 255, 264
	SUNSTAR (日星)		DPK-2/3
	HUANAN (华南)		G16-1
	PEMAL (良模)		PM-780
	SHANGGONG(上工)		G15
	SINGER (胜家)		107W
	YAMATO (大和)		DP-2, -3
	PEGASUS (飞马)		DPS-2, -3, 4
SC70-27	SINGER (胜家)	271785	271K
			
SC70-2M	SINGER (胜家)	224441M	107U, 107W
			
W/MAGNET (附磁铁)			
SC70-2NS	BROTHER (兄弟)	143986101	LH4-B814, -2, -3, -4
	JUKI (重机)	B18107610BA	LBH-761 SERIES
W/NS SPRING (附防止空転弹簧片)			



BOBBIN CASE SPECIAL TYPE : SC



KOBAN NO	MAKER	PART NO	MACHINE
SC70-3 	BROTHER (兄弟)	158471-001	LZ2-8852, -8853, -8854
	JUKI (重机)	23504558	LZ-1280, -1286, -2280, -2285
	STAGER (津久井)		SZ-310
	SINGER (勝家)	502530	457A, 457G, 457U
	TOYOTA (豊田)	2130704-301A	AD550, 551, 552, 553
	TAKING (天王星)		TK-457A, 457U
	FANG HUNG (PLATINA)		TJ-457A
	FLYINGMAN (飛人)		GG302
	JACK (杰克)		JK457
	ZOJE (中捷)		ZJ457A
	CONSEW (康秀)		347R, 375, 376
YULUN (友倫)		457A, YLM-457A	
SC70-31 	PFAFF (百福)	91-008243-91	114, 115, 116, 3114, 3116
SC70-3FL  FLAT LATCH (平彈片)	GOLDEN WHEEL (金輪)		CS-2383
SC70-3M  W/MAGNET (附磁鉄)	SINGER (勝家)	502530M	457A, 457G, 457U
SC70-3NS  W/NS SPRING (附防止空転彈簧片)	JUKI (重机)	23504657	LZ-2280N, -7, -2282N, -7, -2288
	GOLDEN WHEEL (金輪)		CS-2200, 2201
	YAMATO (大和)		LG-2000, 2125
SC70-3TNS  W/NS SPRING (附防止空転彈簧片)	GOLDEN WHEEL (金輪)		CS-2380/2383



BOBBIN CASE SPECIAL TYPE : SC









KOBAN NO	MAKER	PART NO	MACHINE
SC70-771 	JUKI (重机)	B18107710A0	LBH-781 SERIES
	GOLDEN WHEEL (金輪)		CS-2380, 2383, 7800, CSH-7800
	DALIAN (大連)		G18
	JACK (杰克)		JK781
	SHANGGONG (上工)		GF108
	TAKING (天王星)		TK-888, 888VB
SC70-771NS  W/NS SPRING (附防止空転彈簧片)	JUKI (重机)	B181077108A	LBH-771 SERIES
SC980N 	JUKI (重机)	B18289800A0	LK-980
SC980-2  W/NS SPRING (附防止空転彈簧片)	JUKI (重机)	B18289800BB	LK-1851, 1900

SHUTTLE HOOK : SH

KOBAN NO	MAKER	PART NO	MACHINE
☆SH180J 	JUKI (重机)	B1818210000	AMS-211CGS, -215CGS, -220CGS AMS-222BG, CG, -224CG
☆SH180J2 	JUKI (重机)	13876305	LK-1952 ~ 1954



SHUTTLE HOOK : SH

KOBAN NO	MAKER	PART NO	MACHINE
☆SH180JA	JUKI (重机)	B1818210D0A	AMS-210D, LK-1910, -1920, -1930
			
☆SH180JB	JUKI (重机)	B1818210D0B	AMS-210D, LK-1910, -1920, -1930
			
☆SH180JH	JUKI (重机)	40014965	AMS-210
			
☆SH180JAH	JUKI (重机)	40014964	AMS-210
			
SH181	MITSUBISHI(三菱)	MS17A0120	PLK-A2016, -E1010, -E2516, -E4030 PLK-E4519, -E6019, -6030
	SINGER (勝家)	282522	469U, 569U
	SIRUBA (高林)		PK588
SH181H	MITSUBISHI(三菱)	MS17A1120	PLK-A3530, -A4516 PLK-A4516
	SINGER (勝家)	281776	469U, 569U
☆SH205	JUKI (重机)	B1818205000	AMS-205C, 206C, 210B, 210C, 211C, 211P AMS-212C, 215C, 220B, 220CSS, 222B AMS-223CS, 224CS
			
☆SH205H	JUKI (重机)	B181820500B	AMS-220CHS
			



SHUTTLE HOOK : SH

KOBAN NO	MAKER	PART NO	MACHINE
☆SH205H2	JUKI (重机)	B1818205A0B	AMS-215CHS, 223CH, 224CH
			
☆SH215	JUKI (重机)	B1818215P00	AMS-215P
			
SH280	JUKI (重机)	B1818280000	LK-1850, 1851, 1900, 980
	GOLDEN WHEEL (金輪)		CSA-3500, CS- 8150-555/558, CS-3500,8150
	DALIAN (大連)		GD2308
	PEMAL (良機)		PM-1828, 1836, 1850
	SHANGGONG(上工)		GD2302
	TAKING (天王星)		TK-1800, 1814, 1818, 1821, 1828, 1836, 1842
	YXSM (裕祥)		YU-1850-M, -XL
ZOJE (中捷)		ZJ1900, 1903, 1903-303, -304, -305	
			
SH280T	JUKI (重机)	B181828000A	LK-1850, 1851, 1900, 980
			
TITANIUM PLATED (鈦鍍層)			
SH282	JUKI (重机)	D1818282N00	LK-1850J, 1900
	GOLDEN WHEEL (金輪)		CSA-3450, CS8150, 8150-519/695
	TAKING (天王星)		TK-1828H, 1836H, 1842H
	YXSM (裕祥)		YU-1850-XL
	ZOJE (中捷)		ZJ1900HS
			
SH31	SINGER (勝家)	12393	31-15, 331K, 431D200A
			
SH430	BROTHER (兄弟)	152685-301	LK3-B4300E, B430E, B4310E, B431E
		SA1881-001	LK3-B4320E, B432E, B4330E, B433E
			LK3-B4340E, B434E, B435, B4350E
	MITSUBISHI(三菱)	MS01A0120	LK3-B436, B4380E, B438E, B441
			PLK-038TA, -0804, -E0504



SHUTTLE HOOK : SH

KOBAN NO	MAKER	PART NO	MACHINE
SH430-D	BROTHER (兄弟)	SA1869-001	LK3-B430
SH430-H	BROTHER (兄弟)	152687-201	LK3-B430E, B431E, B432E, B433E, B434E
		SA1882-001	LK3-B435, B436, B441
	MITSUBISHI (三菱)	MS01A1120	PLK-0504, 0604, E03BTA
	SIRUBA (高林)		PK533
SH469	SINGER (勝家)	418505	469U, 569U
SH469-H	SINGER (勝家)	418045	469U, 569U
SH469-T	SINGER (勝家)	418505-452	469U, 569U
			TITANIUM PLATED (鈦塗層)
SH570	DURKOPP ADLER (杜克普 / 愛爾)		570
SH61	SINGER (勝家)	40028	269W



SHUTTLE HOOK : SH

KOBAN NO	MAKER	PART NO	MACHINE
SH61-NG 	BROTHER (兄弟)	116827-901	LK3-B220, B221, B222, B223 LK3-B826, B827, B828
SH61CR  CHROME PLATED (鍍鉻)	SINGER (勝家)	40028-003	269W
SH-P1 	PFAFF (百福)	91-006560-91	3125A,B, 3135A,B, 3136A,B, 3331A,B, 3334 ~ 3337A,B, 34-900
SH-P2 	PFAFF (百福)	91-006694-91	2125C, 3135C, 3136C, 3331C, 3334 ~ 3337C 34C,D,S,L, 34-705-915, -915-944



2. WEIGHT AND MEASUREMENT TABLE (重量尺寸表)

ROTARY HOOK HIGH SPEED TYPE : KHS

KOBAN NO	N.W.	G.W.	G.W.	MEASUREMENT
	1PC(G)	12PCS(G)	36PCS(G)	
KHS11S-58	62	782	24,000	26 × 43 × 25
KHS1183-SP	62	782	24,000	26 × 43 × 25
KHS12-2S	62	782	24,000	26 × 43 × 25
KHS12-G	62	782	24,000	26 × 43 × 25
KHS12-GP	62	782	24,000	26 × 43 × 25
KHS12-GS	62	782	24,000	26 × 43 × 25
KHS12-GTH	62	782	24,000	26 × 43 × 25
KHS12-GTHPD	62	782	24,000	26 × 43 × 25
KHS12-GTPN2D2	62	782	24,000	26 × 43 × 25
KHS12-GTPND2	62	782	24,000	26 × 43 × 25
KHS12-R	62	782	24,000	26 × 43 × 25
KHS12-RB	62	782	24,000	26 × 43 × 25
KHS12-RD	62	782	24,000	26 × 43 × 25
KHS12-RP	62	782	24,000	26 × 43 × 25
KHS12-RPN2D2	62	782	24,000	26 × 43 × 25
KHS12-RY	62	782	24,000	26 × 43 × 25
KHS12-RY3N	62	782	24,000	26 × 43 × 25
KHS12-RYN	62	782	24,000	26 × 43 × 25
KHS12-RYNW	62	782	24,000	26 × 43 × 25
KHS12-RYOE	62	782	24,000	26 × 43 × 25
KHS12-RYP	62	782	24,000	26 × 43 × 25
KHS12-RYPAICC	62	782	24,000	26 × 43 × 25
KHS12-RYPICC	62	782	24,000	26 × 43 × 25
KHS12-RYPN	62	782	24,000	26 × 43 × 25
KHS12-RYPNW	62	782	24,000	26 × 43 × 25
KHS12-RYPOE	62	782	24,000	26 × 43 × 25
KHS12-RYPOEJ	62	782	24,000	26 × 43 × 25
KHS12-RYPW	62	782	24,000	26 × 43 × 25
KHS12-S	62	782	24,000	26 × 43 × 25
KHS12-SB2	62	782	24,000	26 × 43 × 25
KHS12-SB3OHO	62	782	24,000	26 × 43 × 25
KHS12-SD	62	782	24,000	26 × 43 × 25
KHS12-SJ2	62	782	24,000	26 × 43 × 25
KHS12-SJH	62	782	24,000	26 × 43 × 25
KHS12-SN	62	782	24,000	26 × 43 × 25
KHS12-SOHO	62	782	24,000	26 × 43 × 25
KHS12-SP	62	782	24,000	26 × 43 × 25
KHS12-SPA3	62	782	24,000	26 × 43 × 25
KHS12-SPB	62	782	24,000	26 × 43 × 25
KHS12-SPB3OHO	62	782	24,000	26 × 43 × 25
KHS12-SPD2	62	782	24,000	26 × 43 × 25
KHS12-SPD3	62	782	24,000	26 × 43 × 25
KHS12-SPD4	62	782	24,000	26 × 43 × 25
KHS12-SPD6	62	782	24,000	26 × 43 × 25

KOBAN NO	N.W.	G.W.	G.W.	MEASUREMENT
	1PC(G)	12PCS(G)	36PCS(G)	
KHS12-SPD8CC	62	782	24,000	26 × 43 × 25
KHS12-SPF	62	782	24,000	26 × 43 × 25
KHS12-SPNJW	62	782	24,000	26 × 43 × 25
KHS12-SPUNS	62	782	24,000	26 × 43 × 25
KHS12-SPW	62	782	24,000	26 × 43 × 25
KHS14-G	62	782	24,000	26 × 43 × 25
KHS14-GN	62	782	24,000	26 × 43 × 25
KHS14-R	62	782	24,000	26 × 43 × 25
KHS14-S	62	782	24,000	26 × 43 × 25
KHS14-SS	62	782	24,000	26 × 43 × 25
KHS271-S	62	782	24,000	26 × 43 × 25
KHS438	70	876	26,000	26 × 43 × 25
KHS480	70	876	26,000	26 × 43 × 25

ROTARY HOOK LARGE TYPE : KHS20

KOBAN NO	N.W.	G.W.	G.W.	MEASUREMENT
	1PC(G)	6PCS(G)	14PCS(G)	
KHS20-GTB	84	540	13,000	22 × 30 × 29
KHS20-GTMP	84	540	13,000	22 × 30 × 29
KHS20-GTVG	84	540	13,000	22 × 30 × 29
KHS20-HPEW	84	540	13,000	22 × 30 × 29
KHS20-R	84	540	13,000	22 × 30 × 29
KHS20-R1E	84	540	13,000	22 × 30 × 29
KHS20-R2E	84	540	13,000	22 × 30 × 29
KHS20-RM2	84	540	13,000	22 × 30 × 29
KHS20-RM3	84	540	13,000	22 × 30 × 29
KHS20-RMP	84	540	13,000	22 × 30 × 29
KHS20-RMPCC	84	540	13,000	22 × 30 × 29
KHS20-RMPN	84	540	13,000	22 × 30 × 29
KHS20-RMPNW	84	540	13,000	22 × 30 × 29
KHS20-RP1ECC	84	540	13,000	22 × 30 × 29
KHS20-RPE	84	540	13,000	22 × 30 × 29
KHS20-RPEM2A0	84	540	13,000	22 × 30 × 29
KHS20-RPNG	84	540	13,000	22 × 30 × 29
KHS20-RTB	84	540	13,000	22 × 30 × 29
KHS20-RY	84	540	13,000	22 × 30 × 29
KHS20-RYN	84	540	13,000	22 × 30 × 29
KHS20-RYP	84	540	13,000	22 × 30 × 29
KHS20-RYPN	84	540	13,000	22 × 30 × 29
KHS20-S	84	540	13,000	22 × 30 × 29
KHS20-SMP	84	540	13,000	22 × 30 × 29
KHS20SPEM2ANG	84	540	13,000	22 × 30 × 29
KHS20-SPNP	84	540	13,000	22 × 30 × 29



ROTARY HOOK LARGE TYPE : KHS20

KOBAN NO	N.W.	G.W.	G.W.	MEASUREMENT
	1PC(G)	6PCS(G)	14PCS(G)	W × L × H(CM)
KHS20-ST	84	540	13,000	22 × 30 × 29
KHS20-TZ	84	540	13,000	22 × 30 × 29
KHS30-RPNG	98	—	—	—

ROTARY HOOK LOW SPEED TYPE : KR

KOBAN NO	N.W.	G.W.	G.W.	MEASUREMENT
	1PC(G)	12PCS(G)	30PCS(G)	W × L × H(CM)
KR134	52	670	21,000	26 × 43 × 25
KR134Z	52	670	21,000	26 × 43 × 25
KR134ZICC	52	670	21,000	26 × 43 × 25
KR134ZVICC	52	670	21,000	26 × 43 × 25
KR16-PFA	52	670	21,000	26 × 43 × 25
KR18	62	782	24,000	26 × 43 × 25
KR21-G	52	670	21,000	26 × 43 × 25
KR21-GTPDE	52	670	21,000	26 × 43 × 25
KR21-R	52	670	21,000	26 × 43 × 25
KR21-RD	52	670	21,000	26 × 43 × 25
KR21-RPDE	52	670	21,000	26 × 43 × 25
KR21-S	52	670	21,000	26 × 43 × 25
KR23-16	52	670	21,000	26 × 43 × 25
KR234	52	670	21,000	26 × 43 × 25
KR238	48	600	19,000	26 × 43 × 25
KR238-14	48	600	19,000	26 × 43 × 25
KR24	52	670	21,000	26 × 43 × 25
KR24-B	52	670	21,000	26 × 43 × 25
KR24-RHPD	52	670	21,000	26 × 43 × 25
KR24-T	52	670	21,000	26 × 43 × 25
KR24-U	59	735	23,000	26 × 43 × 25
KR24U-31	59	735	23,000	26 × 43 × 25
KR24U-42	59	735	23,000	26 × 43 × 25
KR69	48	600	19,000	26 × 43 × 25
KR69-V	48	600	19,000	26 × 43 × 25
KR69-VP	48	600	19,000	26 × 43 × 25

ROTARY HOOK VERTICAL TYPE : KRP

KOBAN NO	N.W.	G.W.	G.W.	MEASUREMENT
	1PC(G)	6PCS(G)	14PCS(G)	W × L × H(CM)
KRP108-R	52	346	8,700	22 × 30 × 29
KRP21	54	360	9,000	22 × 30 × 29
KRP3114	54	360	9,000	22 × 30 × 29
KRP3116	54	360	9,000	22 × 30 × 29
KRP41-B	58	380	9,500	22 × 30 × 29

KOBAN NO	N.W.	G.W.	G.W.	MEASUREMENT
	1PC(G)	6PCS(G)	14PCS(G)	W × L × H(CM)
KRP41-LH	56	366	9,000	22 × 30 × 29
KRP41-LH2	56	366	9,000	22 × 30 × 29
KRP41-R	56	366	9,000	22 × 30 × 29
KRP41-S	56	366	9,000	22 × 30 × 29
KRP457	64	414	10,000	22 × 30 × 29
KRP457ICC	64	414	10,000	22 × 30 × 29
KRP457TICC	64	414	10,000	22 × 30 × 29
KRP457-W	64	414	10,000	22 × 30 × 29
KRP457-W3	64	414	10,000	22 × 30 × 29
KRP457-W3ICC	64	414	10,000	22 × 30 × 29
KRP800	64	414	10,000	22 × 30 × 29
KRP818ICC	64	414	10,000	22 × 30 × 29

ROTARY HOOK STANDARD TYPE WITH SHAFT : KRT

KOBAN NO	N.W.	G.W.	G.W.	MEASUREMENT
	1PC(G)	6PCS(G)	22PCS(G)	W × L × H(CM)
KRT11-5	85	557	7,000	19 × 26 × 28
KRT11-50	85	557	7,000	19 × 26 × 28
KRT11-5S	85	557	7,000	19 × 26 × 28
KRT12-4	82	522	6,600	19 × 26 × 28
KRT12-5-19R	82	522	6,600	19 × 26 × 28
KRT12-5B	84	545	7,000	19 × 26 × 28
KRT12-5BF	84	545	7,000	19 × 26 × 28
KRT12-5BFCI	84	545	7,000	19 × 26 × 28
KRT12-5BFKC	84	545	7,000	19 × 26 × 28
KRT12-5BH	84	545	7,000	19 × 26 × 28
KRT12-5BHR	84	545	7,000	19 × 26 × 28
KRT12-5BK	82	522	6,600	19 × 26 × 28
KRT12-5J	82	522	6,600	21 × 30 × 31
KRT12-5JC	82	522	6,600	21 × 30 × 31
KRT12-5JCI	82	522	6,600	21 × 30 × 31
KRT12-5JI	82	522	6,600	21 × 30 × 31
KRT12-5JK-L	82	522	6,600	21 × 30 × 31
KRT12-5JK-R	82	522	6,600	21 × 30 × 31
KRT12-5JKC-L	82	522	6,600	21 × 30 × 31
KRT12-5JKC-R	82	522	6,600	21 × 30 × 31
KRT12-5M	88	560	7,000	19 × 26 × 28
KRT12-5MC	88	560	7,000	19 × 26 × 28
KRT12-5MCI	88	560	7,000	19 × 26 × 28
KRT12-5MK	82	522	6,600	19 × 26 × 28
KRT12-5MKH	82	522	6,600	19 × 26 × 28
KRT12-5MR	88	560	7,000	19 × 26 × 28
KRT12-5R	90	573	7,500	19 × 26 × 28

ROTARY HOOK STANDARD TYPE WITH SHAFT : KRT

KOBAN NO	N.W.	G.W.	G.W.	MEASUREMENT
	1PC(G)	6PCS(G)	72PCS(G)	W × L × HCM
KRT12-5S	90	573	7,500	19 × 26 × 28
KRT30JC	90	573	7,500	19 × 26 × 28
KRT30JCI	90	573	7,500	19 × 26 × 28
KRT842CI	90	573	7,500	19 × 26 × 28
KRT842FK-S	88	560	7,000	19 × 26 × 28
KRT842F-S	88	560	7,000	19 × 26 × 28
KRT842H-R	88	560	7,000	19 × 26 × 28
KRT842H-S	88	560	7,000	19 × 26 × 28
KRT842KC	88	560	7,000	19 × 26 × 28
KRT845BK	88	560	7,000	19 × 26 × 28

ROTARY HOOK LARGE TYPE WITH SHAFT : KRT

KOBAN NO	N.W.	G.W.	G.W.	MEASUREMENT
	1PC(G)	6PCS(G)	72PCS(G)	W × L × HCM
KRT11-5LJKR	100	646	8,000	21 × 30 × 31
KRT11-5LJKS	100	646	8,000	21 × 30 × 31
KRT11-5LJR	104	674	8,500	21 × 30 × 31
KRT11-5LJS	104	674	8,500	21 × 30 × 31
KRT11-5LLJ-L	112	720	9,000	21 × 30 × 31
KRT11-5LLJ-R	112	720	9,000	21 × 30 × 31
KRT11-5LLJC-L	104	674	8,500	21 × 30 × 31
KRT11-5LLJC-R	104	674	8,500	21 × 30 × 31
KRT12-5LBK2	104	674	8,500	21 × 30 × 31
KRT12-5LJH-R	104	674	8,500	21 × 30 × 31
KRT12-5LJK-L	102	650	8,000	21 × 30 × 31
KRT12-5LJK-R	102	650	8,000	21 × 30 × 31
KRT12-5LJKCL	102	650	8,000	21 × 30 × 31
KRT12-5LJKCR	102	650	8,000	21 × 30 × 31
KRT12-5LM	104	674	8,500	21 × 30 × 31
KRT12-5LMC	104	674	8,500	21 × 30 × 31
KRT12-5LMC-R	104	674	8,500	21 × 30 × 31
KRT12-5LMCV	104	674	8,500	21 × 30 × 31
KRT12-5LMK	104	674	8,500	21 × 30 × 31
KRT12-5LMKC	104	674	8,500	21 × 30 × 31
KRT12-5LMKC-C	104	674	8,500	21 × 30 × 31
KRT12-5LMKC-CI	104	674	8,500	21 × 30 × 31
KRT12-5LMKC-CIV	104	674	8,500	21 × 30 × 31
KRT12-5LMKR	104	674	8,500	21 × 30 × 31
KRT12-5LMR	104	674	8,500	21 × 30 × 31
KRT150LJCIV	104	674	8,500	21 × 30 × 31
KRT26-L	112	720	9,000	21 × 30 × 31
KRT30LJ	104	674	8,500	21 × 30 × 31
KRT30LJC	104	674	8,500	21 × 30 × 31

ROTARY HOOK STANDARD TYPE WITHOUT SHAFT : KRT

KOBAN NO	N.W.	G.W.	G.W.	MEASUREMENT
	1PC(G)	6PCS(G)	72PCS(G)	W × L × HCM
KRT872L	112	720	9,000	21 × 30 × 31
KRT875LC	100	635	7,600	21 × 30 × 31
KRT875LK	100	635	7,600	21 × 30 × 31
KRT8-LCI2-S	116	746	9,000	21 × 30 × 31
KRT8-LCI-S	116	746	9,000	21 × 30 × 31
KRT8-LC-RB-CS	112	720	9,000	21 × 30 × 31
KRT8-LCR-CS	112	720	9,000	21 × 30 × 31
KRT8-LCS-CS	112	720	9,000	21 × 30 × 31
KRT-BL	104	658	8,300	21 × 30 × 31
KRT-BLC	104	658	8,300	21 × 30 × 31
KRT-LS2R	112	720	9,000	21 × 30 × 31
KRT-LS2S	112	720	9,000	21 × 30 × 31
KRT-LSR	112	720	9,000	21 × 30 × 31
KRT-LSRB	112	720	9,000	21 × 30 × 31
KRT-LSS	112	720	9,000	21 × 30 × 31

ROTARY HOOK STANDARD TYPE WITHOUT SHAFT : KRT

KOBAN NO	N.W.	G.W.	G.W.	MEASUREMENT
	1PC(G)	6PCS(G)	144PCS(G)	W × L × HCM
KRT110	48	320	8,000	22 × 30 × 29
KRT136	48	320	8,000	22 × 30 × 29
KRT136M	48	320	8,000	22 × 30 × 29
KRT145	44	300	7,600	22 × 30 × 29
KRT145G	48	320	8,000	22 × 30 × 29
KRT151MO	46	312	8,000	22 × 30 × 29
KRT151R	46	312	8,000	22 × 30 × 29
KRT151RG	50	336	8,600	22 × 30 × 29
KRT151S	46	312	8,000	22 × 30 × 29
KRT151SG	50	336	8,600	22 × 30 × 29
KRT18-R	48	320	8,000	22 × 30 × 29
KRT18-S	48	320	8,000	22 × 30 × 29
KRT190	46	312	8,000	22 × 30 × 29
KRT190G	50	336	8,600	22 × 30 × 29
KRT191	48	320	8,000	22 × 30 × 29
KRT19-R	50	340	8,600	22 × 30 × 29
KRT19-S	50	340	8,600	22 × 30 × 29
KRT21	62	410	10,000	22 × 30 × 29
KRT211	62	400	10,000	22 × 30 × 29
KRT21-J	62	410	10,000	22 × 30 × 29
KRT21-K	62	410	10,000	22 × 30 × 29
KRT21-R	62	410	10,000	22 × 30 × 29
KRT22	62	400	10,000	22 × 30 × 29
KRT236	48	320	8,000	22 × 30 × 29



ROTARY HOOK STANDARD TYPE WITHOUT SHAFT : KRT

KOBAN NO	N.W.	G.W.	G.W.	MEASUREMENT
	IPC(G)	6PCS(G)	14PCS(G)	W × L × H(CM)
KRT31-11R	54	360	9,000	22 × 30 × 29
KRT31-11S	54	360	9,000	22 × 30 × 29
KRT31-11SG	65	440	11,000	22 × 30 × 29
KRT31MIN	50	336	8,600	22 × 30 × 29
KRT31-NR	55	372	9,000	22 × 30 × 29
KRT31-R	50	340	8,500	22 × 30 × 29
KRT31-RG	55	372	9,000	22 × 30 × 29
KRT31-S	50	340	8,500	22 × 30 × 29
KRT31-SG	55	372	9,000	22 × 30 × 29
KRT31-SKG	55	372	9,000	22 × 30 × 29
KRT345G	48	320	8,000	22 × 30 × 29
KRT390	48	320	8,000	22 × 30 × 29
KRT390G	52	344	8,600	22 × 30 × 29
KRT390-HBG	52	344	8,600	22 × 30 × 29
KRT391	52	344	8,600	22 × 30 × 29
KRT412-S	48	320	8,000	22 × 30 × 29
KRT470C2-R	68	444	11,000	22 × 30 × 29
KRT470-CKR	68	444	11,000	22 × 30 × 29
KRT470C-R	68	444	11,000	22 × 30 × 29
KRT470C-S	68	444	11,000	22 × 30 × 29
KRT470MIN	50	336	8,600	22 × 30 × 29
KRT470-O-R	68	444	11,000	22 × 30 × 29
KRT470-O-S	68	444	11,000	22 × 30 × 29
KRT470-R	68	444	11,000	22 × 30 × 29
KRT470-RH	68	444	11,000	22 × 30 × 29
KRT470-RHB	68	444	11,000	22 × 30 × 29
KRT470-RHH	68	444	11,000	22 × 30 × 29
KRT470-S	68	444	11,000	22 × 30 × 29
KRT490-R	68	444	11,000	22 × 30 × 29
KRT490-S	68	444	11,000	22 × 30 × 29
KRT51	48	320	8,000	22 × 30 × 29
KRT571-S	68	444	11,000	22 × 30 × 29
KRT67	44	300	7,800	22 × 30 × 29

ROTARY HOOK LARGE TYPE WITHOUT SHAFT : KRT

KOBAN NO	N.W.	G.W.	G.W.	MEASUREMENT
	IPC(G)	6PCS(G)	14PCS(G)	W × L × H(CM)
KRT1242-R	68	444	11,000	22 × 30 × 29
KRT1242-S	68	444	11,000	22 × 30 × 29
KRT167	68	444	11,000	22 × 30 × 29
KRT1971	76	492	12,300	22 × 30 × 29
KRT211-L	74	472	11,700	22 × 30 × 29
KRT26-LPC	94	598	14,700	22 × 30 × 29

KOBAN NO	N.W.	G.W.	G.W.	MEASUREMENT
	IPC(G)	6PCS(G)	14PCS(G)	W × L × H(CM)
KRT26-LPC2	94	598	14,700	22 × 30 × 29
KRT31-LR	75	485	12,000	22 × 30 × 29
KRT341G	65	440	11,000	22 × 30 × 29
KRT341GI	65	440	11,000	22 × 30 × 29
KRT341-NHI	68	444	11,000	22 × 30 × 29
KRT341-NR	68	444	11,000	22 × 30 × 29
KRT341-NS	68	444	11,000	22 × 30 × 29
KRT341SG	65	440	11,000	22 × 30 × 29
KRT467	157	1,034	—	—
KRT467L	—	—	—	—
KRT467XLI-R	163	—	—	—
KRT470LCI-R	63	—	—	—
KRT470LI-R	63	—	—	—
KRT545	60	390	9,700	22 × 30 × 29
KRT545G	66	430	11,000	22 × 30 × 29
KRT768I-ICC-R	66	—	—	—
KRT867XLI-R	141	—	—	—
KRT8-BL	86	570	13,500	22 × 30 × 29
KRT8-LPK	98	620	15,000	22 × 30 × 29
KRT8-LPK-2	98	620	15,000	22 × 30 × 29
KRT8-LPKD	98	620	15,000	22 × 30 × 29
KRT8-LPR	94	598	14,700	22 × 30 × 29
KRT8-LPS	94	598	14,700	22 × 30 × 29

ROTARY HOOK SPECIAL TYPE : KRT

KOBAN NO	N.W.	G.W.	G.W.	MEASUREMENT
	IPC(G)	6PCS(G)	14PCS(G)	W × L × H(CM)
KRT132	324	2,058	—	—
KRT132-M	324	2,058	—	—
KRT132-MT	324	2,058	—	—
KRT132-SKZ	332	2,106	—	—
KRT133	324	2,058	—	—
KRT14-5	198	1,330	—	—
KRT14-5HP	198	1,330	—	—
KRT14-5-O	195	1,330	—	—
KRT14-5-O-C	195	1,330	—	—
CKRT132SET	72	—	—	—
CKRT133SET	72	—	—	—
OKRT132R	92	—	—	—
OKRT132SET	92	—	—	—
OKRT133R	92	—	—	—



MISCELLANEOUS PARTS : KSP

KOBAN NO	N.W.	G.W.	G.W.	MEASUREMENT
	IPC(G)	6PCS(G)	72PCS(G)	W × L × H(CM)
KSP204	80	—	—	—
KSP204H	80	—	—	—
KSP204N	80	—	—	—
KSP204NH	80	—	—	—
KSP360	20	—	—	—
KSP5934	60	—	—	—
KSP7-31	256	—	—	—
KSP7-9	98	—	—	—

CAP : SCP

KOBAN NO	N.W.	G.W.	G.W.	MEASUREMENT
	IPC(G)	5PCS(G)		W × L × H(CM)
SCP151MO	7	386	—	—
SCP167	12	636	—	—
SCP18	7	386	—	—
SCP18-2	7	386	—	—
SCP26-L	12	636	—	—
SCP31-K	8	436	—	—
SCP31MIN	7	386	—	—
SCP35JJC	7	386	—	—
SCP40JJC	7	386	—	—
SCP470-CK	7	386	—	—
SCP545	12	636	—	—
SCP67	8	436	—	—
SCP-842BC	8	436	—	—
SCP-842BK	8	436	—	—
SCP-842BKC	8	436	—	—
SCP-BK	8	436	—	—
SCP-BL	12	636	—	—
SCP-BLP	12	636	—	—
SCP-JC	8	436	—	—
SCP-JJC	8	436	—	—
SCP-LBC	12	636	—	—
SCP-LBC(J)	12	636	—	—
SCP-LBK	12	636	—	—
SCP-LBKC	12	636	—	—
SCP-LBKC(J)	12	636	—	—
SCP-LJ	12	636	—	—
SCP-LJK	12	636	—	—
SCP-LJJC	12	636	—	—
SCP-LLJ	12	636	—	—
SCP-LMC	12	636	—	—
SCP-LMK	12	636	—	—

KOBAN NO	N.W.	G.W.	G.W.	MEASUREMENT
	IPC(G)	50PCS(G)		W × L × H(CM)
SCP-LMKC	12	636	—	—
SCP-LMKC2	12	636	—	—
SCP-MC	8	436	—	—
SCP-MK	8	436	—	—
SCP-MK3	8	436	—	—
SCP-MKC	8	436	—	—
SCPF15	7	386	—	—
SCPF15H	7	386	—	—
SCPF19	7	386	—	—
SCPF441	7	386	—	—
SCPF571	7	386	—	—

BOBBIN CASE STANDARD TYPE : SC

KOBAN NO	N.W.	G.W.	G.W.	MEASUREMENT
	IPC(G)	50PCS(G)	100PCS(G)	W × L × H(CM)
SC211	10	510	10,500	17 × 26 × 32
SC265	10	510	10,500	17 × 26 × 32
SC31	10	530	11,000	17 × 26 × 32
SC31-BNS2	10	530	11,000	17 × 26 × 32
SC31-NS	10	530	11,000	17 × 26 × 32
SC34-1	9	500	10,300	17 × 26 × 32
SC34-1NS	9	500	10,300	17 × 26 × 32
SC34-2NS	9	500	10,300	17 × 26 × 32
SC35	9	500	10,300	17 × 26 × 32
SC35-NS	9	500	10,300	17 × 26 × 32
SC35-T	9	500	10,300	17 × 26 × 32
SC38	10	530	11,000	17 × 26 × 32
SC39	10	530	11,000	17 × 26 × 32
SC39-14	9	500	10,300	17 × 26 × 32
SC39-14NS	9	500	10,300	17 × 26 × 32
SC39-34NS	9	500	10,300	17 × 26 × 32
SC39-NS	10	530	11,000	17 × 26 × 32
SC639	10	530	11,000	17 × 26 × 32
SC81	10	530	11,000	17 × 26 × 32
SC81-2	10	530	11,000	17 × 26 × 32
SC81-2NS	10	530	11,000	17 × 26 × 32
SC81-2NS2	10	530	11,000	17 × 26 × 32
SC82	10	530	11,000	17 × 26 × 32
SC82-J	9	500	10,300	17 × 26 × 32
SC82-JNS	9	500	10,300	17 × 26 × 32
SC82-JNS2	9	500	10,300	17 × 26 × 32
SC83	9	500	10,300	17 × 26 × 32

BOBBIN CASE LARGE TYPE : SC

KOBAN NO	N.W.	G.W.	G.W.	MEASUREMENT W × L × H(CM)
	1PC(G)	50PCS(G)	500PCS(G)	
SC31-L	16	380	9,800	20 × 27 × 29
SC33-L	15	360	9,300	20 × 27 × 29
SC33-LB	15	360	9,300	20 × 27 × 29
SC33-LD	15	360	9,300	20 × 27 × 29
SC33-LDH	15	360	9,300	20 × 27 × 29
SC33-LM	15	360	9,300	20 × 27 × 29
SC33-LNS	15	360	9,300	20 × 27 × 29
SC33-LNS3	15	360	9,300	20 × 27 × 29
SC33-LNS3S	15	360	9,300	20 × 27 × 29
SC33-LNSH	15	360	9,300	20 × 27 × 29
SC34-L	16	370	9,500	20 × 27 × 29
SC34-LHNS	16	370	9,500	20 × 27 × 29
SC34-LNS	16	370	9,500	20 × 27 × 29
SC34-LZNS	16	370	9,500	20 × 27 × 29
SC35-L	15	360	9,300	20 × 27 × 29
SC35-LNS	16	370	9,500	20 × 27 × 29
SC35-LNSG	16	370	9,500	20 × 27 × 29
SC35-XLNS	21	—	—	—
SC369	16	370	9,500	20 × 27 × 29









SHUTLE HOOK : SH

KOBAN NO	N.W.	G.W.	G.W.	MEASUREMENT W × L × H(CM)
	1PC(G)	10PCS(G)	100PCS(G)	
SH181	20	216	—	—
SH181H	20	216	—	—
SH280	18	196	20,000	25 × 33 × 34
SH280T	18	196	20,000	25 × 33 × 34
SH282	18	196	20,000	25 × 33 × 34
SH31	19	204	21,000	25 × 33 × 34
SH430	18	196	20,000	25 × 33 × 34
SH430-D	18	196	20,000	25 × 33 × 34
SH430-H	18	196	20,000	25 × 33 × 34
SH469	18	196	20,000	25 × 33 × 34
SH469-H	18	196	20,000	25 × 33 × 34
SH469-T	18	196	20,000	25 × 33 × 34
SH51	18	196	20,000	25 × 33 × 34
SH570	19	204	21,000	25 × 33 × 34
SH61	18	196	20,000	25 × 33 × 34
SH61-NG	18	196	20,000	25 × 33 × 34
SH61CR	18	196	20,000	25 × 33 × 34
SH-P1	18	196	20,000	25 × 33 × 34
SH-P2	18	196	20,000	25 × 33 × 34

BOBBIN CASE SPECIAL TYPE : SC

KOBAN NO	N.W.	G.W.	G.W.	MEASUREMENT W × L × H(CM)
	1PC(G)	20PCS(G)	500PCS(G)	
SC181	16	380	—	—
SC181H	16	380	—	—
SC430	12	280	7,300	—
SC70-2	12	280	7,300	—
SC70-27	12	280	7,300	—
SC70-2M	12	280	7,300	—
SC70-2NS	12	280	7,300	—
SC70-3	12	280	7,300	—
SC70-31	12	280	7,300	—
SC70-3FL	12	280	7,300	—
SC70-3M	12	280	7,300	—
SC70-3NS	12	280	7,300	—
SC70-3TNS	12	280	7,300	—
SC70-771	12	280	7,300	—
SC70-771NS	12	280	7,300	—
SC980N	12	280	7,300	—
SC980-2	12	280	7,300	—

3. NON SLIP SPRING : NS (防止空转弹簧片)

	Art. No.	Bobbin Cases
	NS180	SC181 SC181H
	NS31	SC31-NS SC35-NS SC81-NS SC82-NS SC83-NS SC82-JNS SC81-2NS SC211
	NS31-L	SC31-LNS SC34-LNS SC34-LHNS
	NS39	SC39-NS SC39-14NS SC39-7NS
	NS33-LD	SC33-LD SC33-LNS3
	NS33-LB	SC33-LB SC34-LZNS SC35-LB SC369
	NS33-L	SC33-LNS
	NS205	SC205
	NS70	SC70-1NS SC70-2NS SC70-3NS SC70-12NS SC70-31NS SC70-771NS



4. COMPONENT PARTS (构成零件)

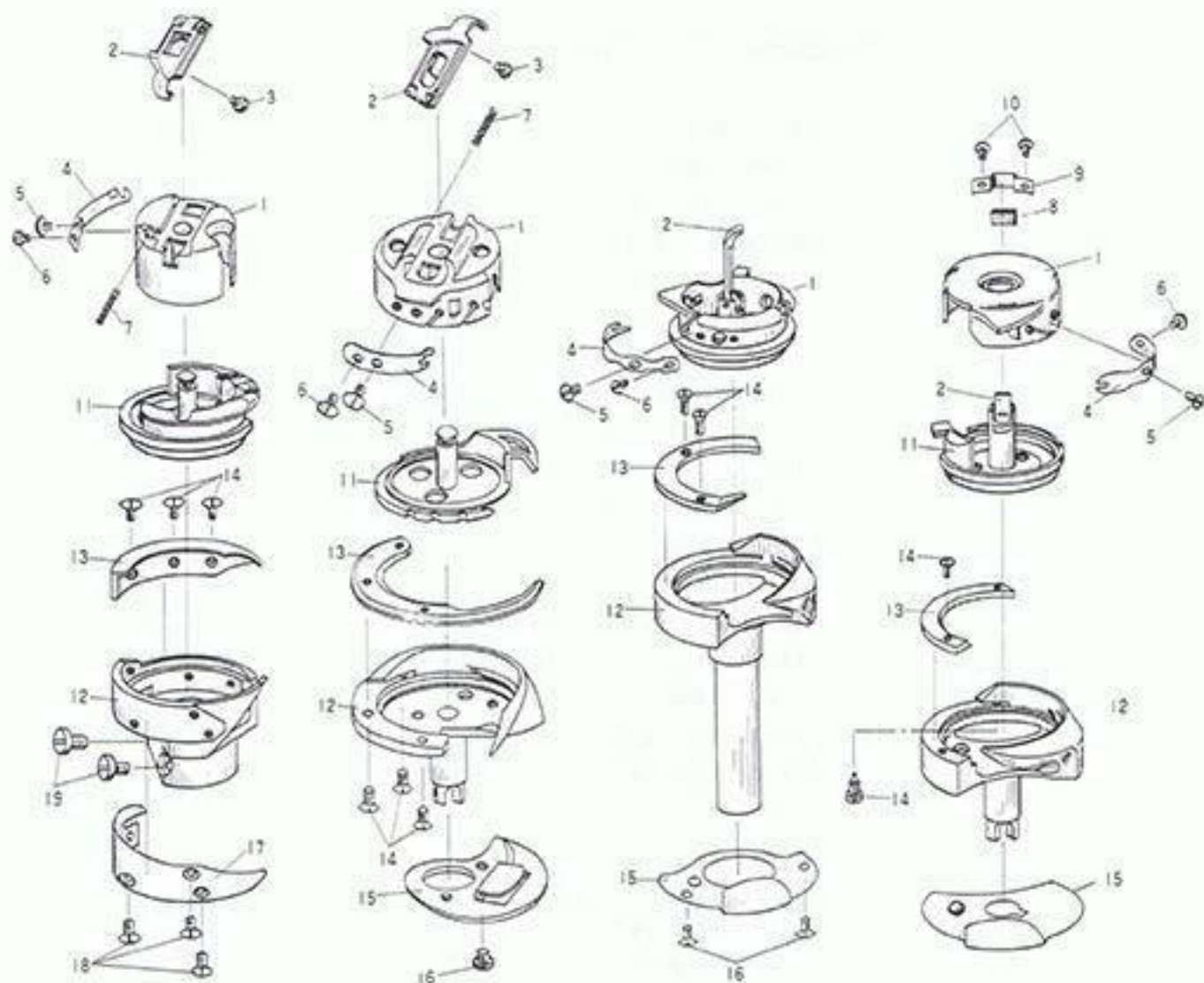

- | | |
|---------------------------------|---------------------------------------|
| 1 Bobbin Case Body (梭壳本体) | 11 Hook Base & Robbin Case Base (内旋梭) |
| 2 Latch (提纽) | 12 Hook Body (外旋梭) |
| 3 Latch Screw (提纽固定螺丝) | 13 Gib (旋梭压板) |
| 4 Tension Spring (张紧弹片) | 14 Gib Screw (旋梭板固定螺丝) |
| 5 T.S. Regulating Screw (调节螺丝) | 15 Hook Washer & Needle Guard (护针片) |
| 6 T.S. Securing Screw (紧固螺丝) | 16 H.W. Screw & N.G. Screw (护针片固定螺钉) |
| 7 Latch Spring (环形弹片) | 17 Thread Guard (外弹片) |
| 8 Green Felt (绿色毛毡) | 18 Thread Guard Screw (外弹片固定螺丝) |
| 9 Felt Holder (毛毡支撑) | 19 Hook Set Screw (安装螺丝) |
| 10 Felt Holder Screw (毛毡支撑固定螺丝) | |



5. REFERENCE TO SEWING MACHINES (厂商名一览)

ABLE (美宝) 91
BAOMA (宝马) 91
BARUDAN (百灵达) 91
BEYOUNG (本佳) 92
BROTHER (兄弟) 92
BUTTERFLY (蝴蝶) 96
CHIKON (奇钢) 96
CHUAN NENG (传能) 96
CHURCHILL (求精) 97
CONSEW (康秀) 97
CUEY FENG (贵峰) 98
DADILI (大地利) 98
DALIAN (大莲) 99
DURKOPP/ADLER (杜克普 / 爱华) 99
FANG HUNG (PLATINA) 99
FEIYUE (飞跃)100
FENG YING (锋颖)100
FLYINGMAN (飞人)100
FOMAX101
GEMSY (宝石)101
GOLDEN WHEEL (金轮)101
HIGHLEAD (海菱)105
HUANAN (华南)106
JACK (杰克)107
JANOME (真善美)107
JUKI (重机)108
JUMBO KING (象王)113
K-CHANCE (高机)113
KERDER (客德)114
KING'S (王品)114
KINGTEX (精机)114
MEIJA (美佳)114
MELCO114
MILLION SPECIAL (万特)115



MITSUBISHI (三菱)116
NECCHI (尼奇)118
NITAKA (日高)118
PANDA (建群)120
PEGASUS (飛馬)120
PEMAL (良機)120
PFAFF (百福)120
PROTEX (通字)122
RICHPEACE (宝盈)123
SANGOOD (双角)123
SEIKO (精工)123
SHANGGONG (上工)126
SICAMA (安機)126
SINGER (勝家)127
SIRUBA (高林)132
STAGER (津久井)134
SUNNUN (信能)134
SUNSTAR (日星)135
TAJIMA (田島)136
TAKING (天王星)136
TANG (經緯)138
TOYOTA (豐田)138
TREASURE (珠寶)139
TYPICAL (標準)139
TYPICAL WANPING (莞坪)140
UNICORN (神馬)141
UNION SPECIAL (於仁)142
YAKUMO (八云)142
YAMATO (大和)144
YULUN (友倫)144
YXSM (裕祥)144
ZGM (珠光)144
ZOJE (中捷)145
ZSK146



ABLE (美宝)

MACHINE (机器)	HOOK (旋梭)				BOBBIN CASE & CAP (梭壳 & 梭帽)		
	PART NO. (配件型号)	EX	KOBAN NO.1 (日文型号1)	KOBAN NO.2 (日文型号2)	PART NO. (配件型号)	EX	KOBAN NO. (日文型号)
HB-100			KR21-R				SC31
HB-150			KR21-S				
HB-300			KHS12-RP				SC31-NS
HB-380			KHS20-GTB				SC33-L
HB-480			KHS12-S				SC31
HB-500			KR21-S				
HB-630			KRT12-5MC				SCP-MK
HBS-2700			KHS12-SPD2				SC31-NS
HBS-5000			KR21-S				SC31
LT2-220BF			KRT12-5LM				
LT2-220ML			KRT12-5M				

BAOMA (宝马)

MACHINE (机器)	HOOK (旋梭)				BOBBIN CASE & CAP (梭壳 & 梭帽)		
	PART NO. (配件型号)	EX	KOBAN NO.1 (日文型号1)	KOBAN NO.2 (日文型号2)	PART NO. (配件型号)	EX	KOBAN NO. (日文型号)
GC0318-1			KHS12-SD				SC82-J
GC0378-1			KRT132				
GC128-M			KHS12-S				SC31
GC158-B			KHS12-R				
GC158-BD			KHS12-RP				SC31-NS
GC158-M			KHS12-S				SC31
GC158-MD			KHS12-SPD2				SC31-NS
GC2018			KRT31-R				
GC20508-C			KRT12-5LM				
GC20508-M			KRT12-5M				
GC20538-C			SKRT12-5LMK with Cap	KRT12-5LMK hook only			SCP-LMK
GC20538-M			SKRT12-5MK with Cap	KRT12-5MK hook only			SCP-MK
GC20608-1, -2			KRT12-5LMC				
GC2318			KRT31-R				
GC2638-1			SKRT341-NR with Cap	KRT341-NR hook only			SCP545
GC2638-2			KRT31-11S				
HG128			KHS12-GTH				
HG128-B			KHS12-R				SC31
HG128-M			KHS12-S				

BARUDAN (百灵达)

MACHINE (机器)	HOOK (旋梭)				BOBBIN CASE & CAP (梭壳 & 梭帽)		
	PART NO. (配件型号)	EX	KOBAN NO.1 (日文型号1)	KOBAN NO.2 (日文型号2)	PART NO. (配件型号)	EX	KOBAN NO. (日文型号)
BEDRH BEDSHE BEDSME BEDTHE BEDT-Z BEDXH BEDYHE BEMR BEMS ELITE	KF220710 KF220970 KF221062 KF221072	☆ ☆ ☆ ☆	KHS12-RYPBNW KHS12-RYPBW KHS12-RYPOEBW3 KHS12-RYPOEOW3	KHS12-RYPNW KHS12-RYPW KHS12-RYPOE KHS12-RYPOEO	KF221010		SC35-NS

SABUN INDUSTRIAL CO., LTD.

☆ = EXCLUSIVE ITEMS



BEYOUNG (本佳)

MACHINE (机器)	HOOK (旋梭)				BOBBIN CASE & CAP (梭壳 & 梭帽)		
	PART NO. (配件型号)	EX	KOBAN NO.1 (日文型号1)	KOBAN NO.2 (日文型号2)	PART NO. (配件型号)	EX	KOBAN NO. (日文型号)
BM-0318-1			KHS20-RM2				SC33-L
BM-1340, -1340V			KRT31-R				
BM-1341, -1341V			SKRT341G with Cap	KRT341G hook only			SCP545
BM-1510, -1560			KRT11-5LJR				
BM-244, -244V			KHS12-GTPND2				SC82-JNS2
BM-246, -246V			KHS20-HPEW				SC33-LD
BM-3358H, -652			KR24-B				SC34-1
BM-810, -820			KRT31-NR				
BM-810H, -820H			KRT31-SGH				
BM-842E-003, -005			KRT12-5M				
BM-872E-005			KRT12-5LM				
BM-88, -88-2			KRT31-R				
BM-9910, -9920			SKRT470-R with Cap	KRT470-R hook only			SCPF15
DB-J706			KHS12-R				SC31
DB-J806			KHS20-RM2				SC33-L

BROTHER (兄弟)

MACHINE (机器)	HOOK (旋梭)				BOBBIN CASE & CAP (梭壳 & 梭帽)		
	PART NO. (配件型号)	EX	KOBAN NO.1 (日文型号1)	KOBAN NO.2 (日文型号2)	PART NO. (配件型号)	EX	KOBAN NO. (日文型号)
BAS-23, -302	153131-901		KHS12-SP		148350-101		SC31-NS
BAS-301	SA1704-001		KHS12-SPB30HO				
BAS-350, -360	SA1722-001		KHS20-SMP		151845-001		SC33-LNS
BAS-400	112041-901		KR24-B		117596-001		SC35
BAS-412, -416, -423	SA1646-001		KHS20-RMP		151845-001		SC33-LNS
BAS-612, 613	SA1692-102		SKRT875LK with Cap	KRT875LK hook only	S09279-001		SCP-LBK
BAS-6150, 6200	SA1694-102		SKRT875LKC with Cap	KRT875LC hook only	S09280-001		SCP-LBKC
BE-0101B-AC BES-1210AC	SA1646-001		KHS20-RMP		S59992-001		SC35-LNS
DB1-B760-3	111274-901		KR21-T				
DB1-B760-5	111272-901		KR21-R				
DB2-B736-1, -3	SA1706-001		KHS12-SB2	KHS12-S	100369-001		SC31
DB2-B736-5	SA1708-001		KHS12-SB30HO				
DB2-B737-3	SA1931-002		KHS12-SPB				
DB2-B737-5	SA1704-001		KHS12-SPB30HO		148350-101		SC31-NS
DB2-B738-3	SA1931-002		KHS12-SPB				
DB2-B738-5	SA1704-001		KHS12-SPB30HO				
DB2-B741-3	SA1722-001		KHS20-SMP				
DB2-B745-5	SA1723-001		KHS20-GTB				
DB2-B745-5, -7 DB2-B746-7	SA1720-001		KHS20-RTB				
DB2-B746-8, -8746A	SA1723-001		KHS20-GTB		151845-001		SC33-LNS
DB2-B747-5, -7	SA1722-001		KHS20-SMP				
DB2-B748-307	SA1646-001		KHS20-RMP				
DB2-B748A DB2-B749-307	SA1722-001		KHS20-SMP				
DB2-B755-3	SA1706-001		KHS12-SB2	KHS12-S	100369-001		SC31
DB2-B755-5	111275-901		KHS12-R				

SABUR INDUSTRIAL CO., LTD.

☆ = EXCLUSIVE ITEMS



BROTHER (兄弟)

MACHINE (机器)	HOOK (旋梭)				BOBBIN CASE & CAP (梭壳 & 梭帽)		
	PART NO. (配件型号)	EX	KOBAN NO.1 (日文型号1)	KOBAN NO.2 (日文型号2)	PART NO. (配件型号)	EX	KOBAN NO. (日文型号)
DB2-B757-103, -105, -203, -205, -3-0, -403, -405, -503, -505	153131-901		KHS12-SP		148350-101		SC31-NS
DB2-B757-3, -5 DB2-B758	SA1706-001		KHS12-SB2	KHS12-S	100369-001		SC31
DB2-B767, -5	111272-901		KR21-R				
DB2-B771	SA1720-001		KHS20-RTB		151845-001		SC33-LNS
	SA1715-001		KHS12-SD		100369-001		SC31
DB2-B773	SA1706-001		KHS12-SB2	KHS12-S			
DB2-B774 DB2-B7740 DB2-B7741	SA1931-002		KHS12-SPB		148350-101		SC31-NS
DB2-B777-3 DB2-B777A	SA1706-001		KHS12-SB2	KHS12-S	100369-001		SC31
					S03245-001		SC31-NS
DB2-B778	SA1931-002		KHS12-SPB		148350-101		SC31-NS
DB2-B781, -1, -2, -3	SA1706-001		KHS12-SB2	KHS12-S	100369-001		SC31
DB2-B781-103, -104, 203, -204, -3-0, -4, -603, 804	153131-901		KHS12-SP		148350-101		SC31-NS
DB2-B790	SA1715-001		KHS12-SD		100369-001		SC31
DB2-B790-3-0	147101-901		KHS12-SPD3		148350-101		SC31-NS
DB2-B790-303					S03245-001		
DB2-B790-5	140882-901		KHS12-RD		100369-001		SC31
DB2-B790-5-0, -505	SA1704-001		KHS12-SPB30HO		148350-101		SC31-NS
DB2-B791-3	SA1715-001		KHS12-SD		100369-001		SC31
DB2-B791-333	147101-901		KHS12-SPD3		148350-101		SC31-NS
DB2-B791-5	140882-901		KHS12-RD		100369-001		SC31
DB2-B791-5-0	SA1704-001		KHS12-SPB30HO		148350-101		SC31-NS
DB2-B792-003, -013, -015, -017	SA1706-001		KHS12-SB2	KHS12-S	100369-001		SC31
DB2-B792-3-0, -400, -503, -613, DB2-B793, -303, -305	153131-901		KHS12-SP		148350-101		SC31-NS
DB2-B795, -313	153131-901		KHS12-SP		148350-101		SC31-NS
DB2-B795-013	SA1706-001		KHS12-SB2	KHS12-S	100369-001		SC31
DB2-B797, -5	SA1720-001		KHS20-RTB		151845-001		SC33-LNS
DB2-B798, -300	SA1722-001		KHS20-SMP				
DD7100	SA1931-002		KHS12-SPB		148350-101		SC31-NS
DL1-8812, -8813	180038-901		KRP41-R		107097-101		SC70-2
HE-8000-2, -3, -5	SA1744-001		KRP800		S50237-001		SC70-3WFLNS
HM-8180	SA1747-001		KRP818ICC DLC coating (像鑽石一樣堅硬的石炭塗層)		S50237-001		
KE-430C	SA1881001		SH430		159610-101		SC430
	SA1882001		SH430-H				
LE2-B861-1	117677-901		KR24		117596-001		SC35
LE2-B861-7	112041-901		KR24-B				
LH4-8814, -2, -3, -4	141307-901		KRP41-B		143986-101		SC70-2NS
LK3-8220, -8221, -8222, -8223, -8826, -8827, -8828	116827-901		SH61-NG				
LK3-8430E, -8430E, -84310E, -8431E, -84320E, -8432E, -84330E, -8433E, -84340E, -8434E, -8435, -84350E, -8436, -84360E, -8436E, -8441	SA1881001 (152685-301)		SH430		159610-101		SC430

SABUR INDUSTRIAL CO., LTD.

☆ = EXCLUSIVE ITEMS



BROTHER (兄弟)

MACHINE (机器)	HOOK (梭头)				BOBBIN CASE & CAP (梭壳 & 梭帽)		
	PART NO. (配件型号)	EX	KOBAN NO.1 (日文型号1)	KOBAN NO.2 (日文型号2)	PART NO. (配件型号)	EX	KOBAN NO. (日文型号)
LK3-B430E, -B431E, -B432E, -B433E, -B434E, -B435, -B436, -B441	SA1882001 (152687-201)		SH430-H		159610-101		SC430
LK3-B484 (XE-484C)	S00688901		KHS30-RPNG		S00691-401		SC35-XLNS
LS2-B891	SA1429-001		KRT467				
LT2-B831, -B831-3	112691-901		KRT12-58F				
LT2-B831-5	144903-901		KRT12-58H				
LT2-B832-1, -3	112691-901		KRT12-58F				
LT2-B832-3-0, -401, -403	158760-901		KRT12-58FCI				
LT2-B832-5	144903-901		KRT12-58H				
LT2-B833	112691-901		KRT12-58F				
LT2-B835, -3, -5, -800	150371-901		SKRT12-58K with Cap	KRT12-58K hook only	151041-001		SCP-BK
LT2-B835-3-0, -400, -5-0, -500	158760-901		KRT12-58FCI				
LT2-B836, -3	155466-901		SKRT12-5LBK2 with Cap	KRT12-5LBK2 hook only	155476-001		SCP-LMKC2
LT2-B837, -5	150966-901		KRT-LS2R				
LT2-B838, -5	153912-901		KRT-LS2S				
LT2-B841	SA1670-111		SKRT842FK-S with Cap	KRT842FK-S hook only	S07740-001		SCP-842BC
LT2-B841-3	SA1668-111		KRT842F-S				
LT2-B841-5	SA1669-111		KRT842H-S				
LT2-B842	SA1677-111		KRT842CI				
	SA1678-111		SKRT842C with Cap	KRT842KC hook only	S07740-001		SCP-842BC
LT2-B842-3	SA1668-111		KRT842F-S				
LT2-B842-403, -405, -903, -905	SA1678-111		SKRT842C with Cap	KRT842KC hook only	S07740-001		SCP-842BC
LT2-B842-5	SA1669-111		KRT842H-S				
LT2-B842-403, -405, -903, -905	SA1677-111		KRT842CI				
LT2-B845, -3, -5, -7	SA1681-111		SKRT845BK with Cap	KRT845BK hook only	S07741-001		SCP-842BK
LT2-B845-403, -405, -407, -903, -905, -907	SA1683-111		SKRT845KC with Cap	KRT842KC hook only	S07742-001		SCP-842BKC
LT2-B847-1	SA1668-111		KRT842F-S				
LT2-B847-1	SA1670-111		SKRT842FK-S with Cap	KRT842FK-S hook only	S07740-001		SCP-842BC
LT2-B847-401, -901	SA1677-111		KRT842CI				
LT2-B847-401, -901	SA1678-111		SKRT842C with Cap	KRT842KC hook only	S07740-001		SCP-842BC
LT2-B848-1	SA1681-111		SKRT845BK with Cap	KRT845BK hook only	S07741-001		SCP-842BK
LT2-B848-401	SA1683-111		SKRT845KC with Cap	KRT842KC hook only	S07742-001		SCP-842BKC
LT2-B872, -3, -5	SA1685-102		KRT872L				
LT2-B872, -403, -405, -903, -905	SA1689-102		SKRT872LC with Cap	KRT875LC hook only	S09278-001		SCP-LBC
LT2-B875, -3, -5, -7	SA1692-102		SKRT875LK with Cap	KRT875LK hook only	S09279-001		SCP-LBK

SABUN INDUSTRIAL CO., LTD.

☆ = EXCLUSIVE ITEMS



BROTHER (兄弟)

MACHINE (机器)	HOOK (梭梭)				BOBBIN CASE & CAP (梭壳 & 梭帽)		
	PART NO. (配件型号)	EX	KOBAN NO.1 (日文型号1)	KOBAN NO.2 (日文型号2)	PART NO. (配件型号)	EX	KOBAN NO. (日文型号)
LT2-8875, -403, -405, -407, -903, -905	SA1694-102		SKRT875LKC with Cap	KRT875LC hook only	S09280-001		SCP-LBKC
LT2-8882	156514-901		KRT12-5LB				
LT2-8892	SA1429-001		KRT467				
LZ1-8851	180038-901		KRP41-R		107097-101		SC70-2
S-7200A-403, -433	SA1931-002		KHS12-SPB				
S-7200A-405, -1010-5, -2010-5, -2010-5, -737A-5 S-7200B-305	SA1704-001		KHS12-SPB30HO		148350-101		SC31-NS
SL-1010-3, -777A-3	SA1706-001		KHS12-SB2	KHS12-S	100369-001		SC31
SL-2010-3, -778A-3	SA1931-002		KHS12-SPB				
SL-2010-5 SL-737A-5	SA1704-001		KHS12-SPB30HO		148350-101		SC31-NS
SL-746A	SA1723-001		KHS20-GTB		151845-001		SC33-LNS
SL-777A-3	SA1706-001		KHS12-SB2	KHS12-S	100369-001		SC31
SL-778A-3	SA1931-002		KHS12-SPB		148350-101		SC31-NS
SN-7230-5, -7240-5	SA1722-001		KHS20-SMP		151845-001		SC33-LNS
SN-771A-3	SA1715-001		KHS12-SD		100369-001		SC31
T-8420A-00F, -033, 03F T-8421A-T03, -T33, -T3F	SA1668-111		KRT842F-S				
T-8421A-T03	SA1670-111		SKRT842FK-S with Cap	KRT842FK-S hook only	S07740-001		SCP-842BC
T-8421A-T05	SA1669-111		KRT842H-S				
T-8422A-403, -405, -433	SA1677-111		KRT842CI				
T-8422A-403	SA1678-111		SKRT842C with Cap	KRT842KC hook only	S07740-001		SCP-842BC
T-8450A-003, -005, -033	SA1681-111		SKRT845BK with Cap	KRT845BK hook only	S07741-001		SCP-842BK
T-8452A-403, -405, -406	SA1683-111		SKRT845KC with Cap	KRT842KC hook only	S07742-001		SCP-842BKC
T-8720A-003, -005	SA1685-102		KRT872L				
T-8722A-403, -405	SA1689-102		SKRT872LC with Cap	KRT875LC hook only	S09278-001		SCP-LBC
T-8750A-003, -005	SA1692-102		SKRT875LK with Cap	KRT875LK hook only	S09279-001		SCP-LBK
T-8752A-403, -405	SA1694-102		SKRT875LKC with Cap	KRT875LC hook only	S09280-001		SCP-LBKC
TA1-B621/ TA2-B622	111274-901		KR21-T		100369-001		SC31
TL-847A	SA1668-111		KRT842F-S				
TL-847B	SA1677-111		KRT842CI				
TL-848A	SA1681-111		SKRT845BK with Cap	KRT845BK hook only	S07741-001		SCP-842BK
TL-848B	SA1683-111		SKRT845KC with Cap	KRT842KC hook only	S07742-001		SCP-842BKC
TN-842A-003, -00F	SA1668-111		KRT842F-S				
TN-842A-005	SA1669-111		KRT842H-S				
TN-842B-403, -405, -40F	SA1677-111		KRT842CI				
TN-842B-40F	SA1678-111		SKRT842C with Cap	KRT842KC hook only	S07740-001		SCP-842BC

SABUN INDUSTRIAL CO., LTD.

☆ = EXCLUSIVE ITEMS

**BROTHER (兄弟)**

MACHINE (机器)	HOOK (旋梭)				BOBBIN CASE & CAP (梭壳 & 梭帽)		
	PART NO. (配件型号)	EX	KOBAN NO.1 (日文型号1)	KOBAN NO.2 (日文型号2)	PART NO. (配件型号)	EX	KOBAN NO. (日文型号)
TN-845A-003, -005	SA1681-111		SKRT845BK with Cap	KRT845BK hook only	S07741-001		SCP-842BK
TN-845A-403, -405 TN-845B-401, -403, -405	SA1683-111		SKRT845KC with Cap	KRT842KC hook only	S07742-001		SCP-842BKC
TN-872A-003-005	SA1685-102		KRT872L				
TN-872B-403, -405	SA1689-102		SKRT872LC with Cap	KRT875LC hook only	S09278-001		SCP-LBC
TN-875A-003, -005	SA1692-102		SKRT875LK with Cap	KRT875LK hook only	S09279-001		SCP-LBK
TZ1-8651, -8652	112041-901		KR24-B		117596-001		SC35
LZ2-8952, -8953, -8954	S34847-901		KRP457		158471-001		SC70-3
ZE-855A, 8570	SA1852-001		KRP457TICC DLC coating (像鑽石一樣堅硬的石炭塗層)		S48180-101		-

BUTTERFLY (蝴蝶)

MACHINE (机器)	HOOK (旋梭)				BOBBIN CASE & CAP (梭壳 & 梭帽)		
	PART NO. (配件型号)	EX	KOBAN NO.1 (日文型号1)	KOBAN NO.2 (日文型号2)	PART NO. (配件型号)	EX	KOBAN NO. (日文型号)
GC2-1			KR24				SC35
GC25-1, -2 GC2601			KHS12-S				SC31
GC57-1			KR24				SC35
GG305-1			KHS12-RYP				SC35-NS
GG3-1			KRP457				SC70-3
GY4-1			KRP41-LH2				SC70-771

CHIKON (奇鋼)

MACHINE (机器)	HOOK (旋梭)				BOBBIN CASE & CAP (梭壳 & 梭帽)		
	PART NO. (配件型号)	EX	KOBAN NO.1 (日文型号1)	KOBAN NO.2 (日文型号2)	PART NO. (配件型号)	EX	KOBAN NO. (日文型号)
CK-1461			KSP204N				
CK-1508, -1560			KRT11-5LJR				
CK-243, -273, -441, -461, -471			KSP204N				
CK-1541, -1541-25			KHS20-HPEW				SC33-LD
CK-663, -1508, -1509, -25, -1560, -1560-25			KRT12-5LJH-R				
CK-767			KSP7-31				
CK-88L, -88L-1			KHS20-RPEM2AO				SC33-LD
SD-767TR SLH-2B, -767R			KSP7-31				
STH-88L			KHS20-RPEM2AO				SC33-LD

CHUAN NENG (傳能)

MACHINE (机器)	HOOK (旋梭)				BOBBIN CASE & CAP (梭壳 & 梭帽)		
	PART NO. (配件型号)	EX	KOBAN NO.1 (日文型号1)	KOBAN NO.2 (日文型号2)	PART NO. (配件型号)	EX	KOBAN NO. (日文型号)
CN-990-3			KHS12-S				SC31
CN-990-5, -7			KHS12-R				

SABUR INDUSTRIAL CO., LTD.

☆ = EXCLUSIVE ITEMS



CHUAN NENG (傳能)

MACHINE (機器)	HOOK (梭梭)				BOBBIN CASE & CAP (梭壳 & 梭帽)		
	PART NO. (配件型号)	EX	KOBAN NO.1 (日文型号1)	KOBAN NO.2 (日文型号2)	PART NO. (配件型号)	EX	KOBAN NO. (日文型号)
CN-991-3, -5, -7			KHS12-RP				SC31-NS
CN-991-3 CN-992-3			KHS12-SPD2				
CN-992-5, -7			KHS12-RP				

CHURCHILL (求精)

MACHINE (機器)	HOOK (梭梭)				BOBBIN CASE & CAP (梭壳 & 梭帽)		
	PART NO. (配件型号)	EX	KOBAN NO.1 (日文型号1)	KOBAN NO.2 (日文型号2)	PART NO. (配件型号)	EX	KOBAN NO. (日文型号)
QJ2230B			KRT12-5LM				
QJ2230M			KRT12-5M				
QJ2250			SKRT12-5MK with Cap	KRT12-5MK hook only			SCP-MK
QJ2250B			SKRT12-5LMK with Cap	KRT12-5LMK hook only			SCP-LMK
QJ5200, 5550			KHS12-S				SC31
QJ842-3			KRT842F-S				
QJ842-5			KRT842H-S				
QJ845			SKRT845BK with Cap	KRT845BK hook only			SCP-842BK
QJ8700			KHS12-S				SC31
QJ872			KRT872L				
QJ875			SKRT875LK with Cap	KRT875LK hook only			SCP-LBK
QJ8900			KHS12-S				SC31

CONSEW (廣秀)

MACHINE (機器)	HOOK (梭梭)				BOBBIN CASE & CAP (梭壳 & 梭帽)		
	PART NO. (配件型号)	EX	KOBAN NO.1 (日文型号1)	KOBAN NO.2 (日文型号2)	PART NO. (配件型号)	EX	KOBAN NO. (日文型号)
120	2120304-310B		KHS20-S		2120304-301		SC33-L
133A	279		KR24-T		284		SC35-T
139	10655		KRT11-5				
146RB	712		KHS20-TZ		714		SC34-L
175	2130104-300B		KHS20-ST		2130104-301C		
205RB	18849		KHS20-RM3		1144		SC33-LNS
206RB	18033		KHS20-RPEM2AO		18045		SC33-LD
207, 223	13086		KRT31-11S				
224, 225, 226	10655		KRT11-5				
227	13086		KRT31-11S				
228, 228, 229, 229R, 229R-1	12032		KRT31-R				
230	2113004-310		KHS12-S		2110104-301C		SC31
230B	2110904-310		KHS12-GTH				
231R	2113004-310		KHS12-S				
231RH	2110904-310		KHS12-GTH				
237	10655		KRT11-5				
238	12032		KRT31-R				
239	10655		KRT11-5				
244, 254B, 255	15040		KRT-LSR				

SABUR INDUSTRIAL CO., LTD.

☆ = EXCLUSIVE ITEMS



CONSEW (康秀)

MACHINE (机器)	HOOK (旋梭)				BOBBIN CASE & CAP (梭壳 & 梭帽)		
	PART NO. (配件型号)	EX	KOBAN NO.1 (日文型号1)	KOBAN NO.2 (日文型号2)	PART NO. (配件型号)	EX	KOBAN NO. (日文型号)
277R	17033		KR69-V				SC39-14
282, 289	12032		KRT31-R				
290RATCW	2111704-310C		KHS12-SPA3		2110604-301B		SC31-NS
291R	2113004-310		KHS12-S		2110104-301C		SC31
291RATCW	2111704-310C		KHS12-SPA3		2110604-301B		SC31-NS
291RH	2110904-310		KHS12-GTH		2110104-301C		SC31
306RB	18033		KHS20-RPEM2A0		18045		SC33-LD
312RATC, 314RATC, 3151RATC	2111704-310C		KHS12-SPA3		2110604-301B		SC31-NS
315R	2121604-310B		KHS12-SD		2110104-301C		SC31
318-1RATC	2111704-310C		KHS12-SPA3		2110604-301B		SC31-NS
318R	2113004-310		KHS12-S		2110104-301C		SC31
327R-1	16291		SKRT12-5BK with Cap	KRT12-5BK hook only			SCP-8K
327RB-1	15850		SKRT26-L with Cap	KRT26-L hook only			SCP26-L
328RB-1	16407		SKRT-BL with Cap	KRT-BL hook only			SCP-BL
332	15875		KRT12-5B				
333, 339	15502		KRT-LSS				
357, 358, 359	12032		KRT31-R				
382, 388, 389	13086		KRT31-11S				
722	279		KR23-16		284		SC35-T
757	28837C		KSP204				
825	279		KR23-16		284		SC35-T
SK-6, -7, -8	1343C		KRT132				
TE-6, TF-6	8028		KRT68				

CUEY FENG (貴峰)

MACHINE (机器)	HOOK (旋梭)				BOBBIN CASE & CAP (梭壳 & 梭帽)		
	PART NO. (配件型号)	EX	KOBAN NO.1 (日文型号1)	KOBAN NO.2 (日文型号2)	PART NO. (配件型号)	EX	KOBAN NO. (日文型号)
GF204, CM			KSP204				
GF204-370, 205, 205-335, 205-370			KSP204N				
GF204-221, 221- 205			KRT14-5HP				

DADILI (大地利)

MACHINE (机器)	HOOK (旋梭)				BOBBIN CASE & CAP (梭壳 & 梭帽)		
	PART NO. (配件型号)	EX	KOBAN NO.1 (日文型号1)	KOBAN NO.2 (日文型号2)	PART NO. (配件型号)	EX	KOBAN NO. (日文型号)
DB2-B111-3			KHS12-S				SC31
DB2-B111-5			KHS12-R				
LT2-B842-3			KRT842F-S				
LT2-B842-5			KRT842H-S				
LT2-B845-3, -5			SKRT845BK with Cap	KRT845BK hook only			SCP-842BK
LT2-B872-3, -5			KRT872L				
LT2-B875-3, -5			SKRT875LK with Cap	KRT875LK hook only			SCP-LBK

SABUN INDUSTRIAL CO., LTD.

☆ = EXCLUSIVE ITEMS



DALIAN (大連)

MACHINE (機器)	HOOK (旋梭)				BOBBIN CASE & CAP (梭壳 & 梭帽)		
	PART NO. (配件型号)	EX	KOBAN NO.1 (日文型号1)	KOBAN NO.2 (日文型号2)	PART NO. (配件型号)	EX	KOBAN NO. (日文型号)
G18			KRP41-LH2				SC70-771
GD2308			SH280				SC980N

DURKOPP/ADLER (杜克普 / 愛華)

MACHINE (機器)	HOOK (旋梭)				BOBBIN CASE & CAP (梭壳 & 梭帽)		
	PART NO. (配件型号)	EX	KOBAN NO.1 (日文型号1)	KOBAN NO.2 (日文型号2)	PART NO. (配件型号)	EX	KOBAN NO. (日文型号)
167, 168	167-00-181-4W/O CAP		KRT167		167-178-4		SCP167
199	199-15-281-4W/O BC		KR23-16		089-178-4		SC35-T
20, 21	20-195		KSP7-31				
204, 205	204-15-010-4		KSP204				
206, 207	204695		KR21-S				SC31
21	20-195		KSP7-31				
211	211-1101		—		211275		SC211
220	220-181-4		KRT14-5				
252, 253, 254, 255, 264	098-15-007-4W/O BC		KRP41-S				SC70-2
265	265-21-142		KRT132				
267, 268	167-00-181-4W/O CAP		KRT167		167-178-4		SCP167
270	204695		KR21-S				SC31
271	271751		KHS271-S				
271	0271150054 ALT		KHS271-SICC DLC COATING (像鑽石一樣堅硬的石炭塗層)				SC33-NS
289	199-15-281-4W/O BC		KR23-16		089-178-4		SC35-T
296, 396	396-15-181-4W/O BC		KHS29		89-178-C		SC83
460	460243		KRP108-R				
467	467-15-009-4		KRT467				
48	048-00-125-2		KRT68				
489	199-15-281-4W/O BC		KR23-16		089-178-4		SC35-T
570	570-1242		SH570				
67, 68	68-00-181-4W/O CAP		KRT67		068-178-4		SCP67
69-373	69-00-581-4W/O BC		KR69				SC39
767 XXL	0767150334		KRT467XLI-R				
768	0768151834		KRT768I-ICC-R				
867 XXL	0667155634		KRT867XLI-R				
91	098-15-007-4W/O BC		KRP41-S				SC70-2
96	096-15-281-4W/O BC		KR21-S				SC31
98	098-15-007-4W/O BC		KRP41-S				SC70-2

FANG HUNG (PLATINA)

MACHINE (機器)	HOOK (旋梭)				BOBBIN CASE & CAP (梭壳 & 梭帽)		
	PART NO. (配件型号)	EX	KOBAN NO.1 (日文型号1)	KOBAN NO.2 (日文型号2)	PART NO. (配件型号)	EX	KOBAN NO. (日文型号)
TJ-3300			KHS20-R				SC33-L
TJ-335, -335H-BH			KR24-B				SC35
TJ-457			KRP457-W				SC70-3
TJ-457A			KRP457				
TJ-652			KR24-B				SC35
TJ-842			KRT12-5BF				

SABUR INDUSTRIAL CO., LTD.

☆ = EXCLUSIVE ITEMS

**FANG HUNG (PLATINA)**

MACHINE (機器)	HOOK (旋梭)				BOBBIN CASE & CAP (梭壳 & 梭帽)		
	PART NO. (配件型号)	EX	KOBAN NO.1 (日文型号1)	KOBAN NO.2 (日文型号2)	PART NO. (配件型号)	EX	KOBAN NO. (日文型号)
TJ-845			SKRT12-5BK with Cap	KRT12-5BK hook only			SCP-BK
TJ-8700			KHS12-S				SC31
TJ-8700-7			KHS12-SPD2				SC31-NS

FEIYUE (飛躍)

MACHINE (機器)	HOOK (旋梭)				BOBBIN CASE & CAP (梭壳 & 梭帽)		
	PART NO. (配件型号)	EX	KOBAN NO.1 (日文型号1)	KOBAN NO.2 (日文型号2)	PART NO. (配件型号)	EX	KOBAN NO. (日文型号)
GC1-5			KR21-S				SC31
GC15-1, -2			KHS12-S				
GC15-3			KHS12-GTH				
GC15-4			KHS12-S				
GC1-6			KR21-S				SC35
GC28-1			KR24				
GC28-1			KHS12-GTH				SC31
GC28-2, -3			KR24				SC35
GC28-3			KHS12-GTH				SC31
GC290			KHS12-S				SC35
GC29-1			KR24				SC31
GC5530, 5550			KHS12-S				SC35
GG30			KR24				SC31

FENG YING (鋒穎)

MACHINE (機器)	HOOK (旋梭)				BOBBIN CASE & CAP (梭壳 & 梭帽)		
	PART NO. (配件型号)	EX	KOBAN NO.1 (日文型号1)	KOBAN NO.2 (日文型号2)	PART NO. (配件型号)	EX	KOBAN NO. (日文型号)
FY-241			KHS20-HPEW				SC33-LD
FY-245, -245V			KHS12-GTPND2				SC82-J
FY-246, -246V			KHS20-HPEW				SC33-LD
FY-341			SKRT341G with Cap	KRT341G hook only			SCP545
FY-810, -820, -985			KRT31-NR				

FLYINGMAN (飛人)

MACHINE (機器)	HOOK (旋梭)				BOBBIN CASE & CAP (梭壳 & 梭帽)		
	PART NO. (配件型号)	EX	KOBAN NO.1 (日文型号1)	KOBAN NO.2 (日文型号2)	PART NO. (配件型号)	EX	KOBAN NO. (日文型号)
GC20502-4			KRT12-5M				SC33-L
GC20601			KHS20-R				
GC51-1, GC9002			KHS12-S				SC31
GC9002H			KHS12-R				SC35
GG0802			KR24				SC70-3
GG302			KRP457				

SABUN INDUSTRIAL CO., LTD.

☆ = EXCLUSIVE ITEMS



FOMAX

MACHINE (机器)	HOOK (旋梭)				BOBBIN CASE & CAP (梭壳 & 梭帽)		
	PART NO. (配件型号)	EX	KOBAN NO.1 (日文型号1)	KOBAN NO.2 (日文型号2)	PART NO. (配件型号)	EX	KOBAN NO. (日文型号)
KDD-5570			KHS12-S				SC31
KDD-5570-7			KHS12-SPD2				
KDD-5570H			KHS12-GTH				SC31-NS
KDD-5570H-7			KHS12-GTHPD				
KDD-5570HB			KHS20-R				SC33-L

GEMSY (宝石)

MACHINE (机器)	HOOK (旋梭)				BOBBIN CASE & CAP (梭壳 & 梭帽)		
	PART NO. (配件型号)	EX	KOBAN NO.1 (日文型号1)	KOBAN NO.2 (日文型号2)	PART NO. (配件型号)	EX	KOBAN NO. (日文型号)
2000-1M			KRT12-5M				
2000-2B			SKRT12-5LMK with Cap	KRT12-5LMK hook only			SCP-LMK
2000-2M			SKRT12-5MK with Cap	KRT12-5MK hook only			SCP-MK
2001-1B			KRT12-5LM				
20U23/123T, 20U33/43, 20U42			KR24U-42				SC35
5550			KHS12-S				SC31
5590H			KHS12-R				
7070, 7080, 7-18			KHS12-S				SC33-L
7-18A			KHS20-R				
7-28			KHS12-S				SC31
7-28H			KHS12-R				
736			KHS12-S				
845			SKRT845BK with Cap	KRT845BK hook only			SCP-842BK
8500, 8700			KHS12-S				SC31
8700H			KHS12-R				
872			KRT872L				
872-7			SKRT872LC with Cap	KRT875LC hook only			SCP-LBC
875			SKRT875LK with Cap	KRT875LK hook only			SCP-LBK
875-7			SKRT875LKC with Cap	KRT875LC hook only			SCP-LBKC
8900			KHS12-S				SC31
8900-7			KHS12-SPD2				SC31-NS
8900H			KHS12-R				SC31
8900H-7			KHS12-SPD2				SC31-NS
9000W			KHS12-SPD8CC				
GEM5550, 8, GEMS			KHS12-S				SC31

GOLDEN WHEEL (金輪)

MACHINE (机器)	HOOK (旋梭)				BOBBIN CASE & CAP (梭壳 & 梭帽)		
	PART NO. (配件型号)	EX	KOBAN NO.1 (日文型号1)	KOBAN NO.2 (日文型号2)	PART NO. (配件型号)	EX	KOBAN NO. (日文型号)
CS-1100F			KHS12-S				SC31
CS-1100H, -1100S			KHS12-R				

SABUR INDUSTRIAL CO., LTD.

☆ = EXCLUSIVE ITEMS

GOLDEN WHEEL (金輪)

MACHINE (机種)	HOOK (鉤)				BOBBIN CASE & CAP (梭壳 & 梭帽)		
	PART NO. (配件型号)	EX	KOBAN NO.1 (日文型号1)	KOBAN NO.2 (日文型号2)	PART NO. (配件型号)	EX	KOBAN NO. (日文型号)
CS-2040, -2050			KSP204H				
CS-2110			KR24-T				SC35-T
CS-2160, -2161, -2162			KHS20-TZ				SC34-L
CS-2180			KR24U-42				SC35-T
CS-2200, -2201			KRP457-H				SC70-3NS
CS-2280			KR69-V				SC39-14
CS-2380, -2380			KRP457TICC DLC coating (像鑽石一樣堅硬的石炭塗層)				SC70-3T
CS-2401-T			SKRT470-O-R with Cap	KRT470-O-R hook only			SCPF15
CS-243, 273			KSP204N				
CS-3100-3			KRT12-5BH				
CS-3100L			KRT12-5LM				
CS-3101			KRT842H-S				
CS-3101-5			KRT842H-R				
CS-3101-L			KRT872L				
CS-3150, -3, -5			SKRT12-5BK with Cap	KRT12-5BK hook only			SCP-BK
CS-3150-L			SKRT875LK with Cap	KRT875LK hook only			SCP-LBK
CS-335BH, -335U			KR24-B				SC35
CS-350			KR21-R				SC31
CS-350L			KHS20-R				SC33-L
CS-350L-T			KHS20-RMP				SC33-LNS
CS-3600			KR21-S				SC31
CS-3610			KRT31-R				
CS-3811			KHS20-R				SC33-L
CS3L-7241			KRT12-5LMC				
CS3L-7243			KRT11-5LJR				
CS-411			KSP204H				
CS-411N			KSP204N				
CS-4150			KRT12-5LMCR				
CS-4150BT			KRT12-5LMKC-CI				
CS-4250			KRT12-5LMC-R				
CS-4250BT			KRT12-5LMKC-CI				
CS-441, -451, 471, -491			KSP204N				
CS-5100			KHS12-S				SC31
CS-5100-5, H, HL			KHS12-R				
CS-5100-5-BT, H-BT, HL-BT			KHS12-RP				SC31-NS
CS-5100-BT			KHS12-SPD2				
CS-5150			KHS12-R				SC31
CS-5150BT			KHS12-RP				SC31-NS
CS-5150L			KHS20-RM2				SC33-L
CS-5150L-BT			KHS20-RMP				SC33-LNS
CS-5150S			KHS12-S				SC31
CS-5150S-BT			KHS12-SPD2				SC31-NS
CS-5200			KHS12-S				SC31
CS-530-100			KSP360				
CS-5361N, -5362N			KRT31-NR				
CS-5371N, -5372N			KRT31-LR				
CS-6000			KHS12-S				SC31
CS-6000-BT			KHS12-RP				SC31-NS

SABUN INDUSTRIAL CO., LTD.

☆ = EXCLUSIVE ITEMS



GOLDEN WHEEL (金輪)

MACHINE (机种)	HOOK (度梭)				BOBBIN CASE & CAP (梭壳 & 梭帽)		
	PART NO. (配件型号)	EX	KOBAN NO.1 (日文型号1)	KOBAN NO.2 (日文型号2)	PART NO. (配件型号)	EX	KOBAN NO. (日文型号)
CS-6100, -6102			KHS20-R				SC33-L
CS-6102BT			KHS20-RMP				SC33-LNS
CS-6103N			KHS20-R				SC33-L
CS-6103N-BT			KHS20-RMP				SC33-LNS
CS-6104N			KHS20-R				SC33-L
CS-6104N-BT			KHS20-RMP				SC33-LNS
CS-6140N-P			KHS20-RNP				SC33-LNS
CS-6111BFT, FT, T			SKRT470C-R with Cap	KRT470C-R hook only			SCPF441
CS-611T (CSA)			SKRT470CT-R with Cap	KRT470CT-R hook only			
CS-6111LT			SKRT1972 with Cap	KRT1972 hook only			SCP545C
CS-6112BFT, FT			SKRT470C-R with Cap	KRT470C-R hook only			SCPF441
CS-6112LT			KRT1971				
CS-6112T			SKRT470C-R with Cap	KRT470C-R hook only			SCPF441
CS-6120, -6130			KHS20-R				SC33-L
CS-6130BT			KHS20-RMP				SC33-LNS
CS-6132			KHS20-R				SC33-L
CS-6132BT			KHS20-RMP				SC33-LNS
CS-6220B			KHS20-RP1E				SC33-LNSH
CS-6310			KHS20-R				SC33-L
CS-6500, -6501			KRT132				
CS-7162			KRT12-5M				
CS-7162-BT			KRT12-5MCI-NS				
CS-7162S			KRT12-5M				
CS-7162S-BT			KRT12-5MCI-NS				
CS-7165, S			SKRT12-5MK with Cap	KRT12-5MK hook only			SCP-MK
CS-7165-BT			KRT12-5MC-NS				SCP-MKC
CS-7165S-BT							
CS-7172			KRT12-5LM				
CS-7172-BT			KRT12-5LMKCI-NS				
CS-7175			SKRT12-5LMK with Cap	KRT12-5LMK hook only			SCP-LMK
CS-7175BT, -7175H-BT			SKRT12-5LMKC-NS with Cap	KRT12-5LMKC-NS hook only			SCP-LMKC
CS-7200			SKRT18-RG with Cap	KRT18-RG hook only			SCP18
CS-7351N, -7362N			KRT31-NR				
CS-7500			KHS12-GTHD				SC31
CS-7500-5			KHS12-R				
CS-7500-5-BT			KHS12-RP				SC31-NS
CS-7500BT			KHS12-GTHPDT				
CS-7800			KRP41-LH2				SC70-771
CS-8000-20, -25, -30			KR21-S				SC31
CS-810			KRT31-NR				
CS-8113			KHS20-HPEW				SC33-LDH
CS-8150, -519/895			SH282				SC980-2
CS-8150-555/558			SH280				
CS-8172BT			KRT12-5LMKC-CI				
CS-8173D-BT			SKRT872LC with Cap	KRT875LC hook only			SCP-LBC

SABUN INDUSTRIAL CO., LTD.

☆ = EXCLUSIVE ITEMS



GOLDEN WHEEL (金輪)

MACHINE (機種)	HOOK (筚梭)				BOBBIN CASE & CAP (梭壳 & 梭帽)			
	PART NO. (配件型号)	EX	KOBAN NO.1 (日文型号1)	KOBAN NO.2 (日文型号2)	PART NO. (配件型号)	EX	KOBAN NO. (日文型号)	
CS-8175BT			SKRT12-5LMKC-NS with Cap	KRT12-5LMKC-NS hook only			SCP-LMKC	
CS-8176D			SKRT875LK with Cap	KRT875LK hook only			SCP-LBK	
CS-8185D-BT			SKRT845KC with Cap	KRT842KC hook only			SCP-842BKC	
CS-820, -821, -822			KRT31-NR					
CS-8233, -NR			SKRT341G with Cap	KRT341G hook only			SCP545	
CS-8242			KRT31-11SG					
CS-8243			SKRT341-NR with Cap	KRT341-NR hook only			SCP545	
CS-8330, -8350			KRT31-LR					
CS-8360, -8361			SKRT470-RH with Cap	KRT470-RH hook only			SCPF15H	
CS-8365, -8366, -8367, -8368			SKRT390-HBG with Cap	KRT390-HBG hook only				
CS-8369, M, MH, MHR, MR, R			SKRT470-R with Cap	KRT470-R hook only			SCPF15	
CS-8369VHS, MHSR, MS, MSR, S, SR			SKRT31MIN with Cap	KRT31MIN hook only			SCP31MIN	
CS-8370, -8371			SKRT8-LPK-2 with Cap	KRT8-LPK hook only			SCP26-L	
CS-861, -862			SKRT470-R with Cap	KRT470-R hook only			SCPF15	
CS-8703, V			KRT24-B				SC35	
CS-8713, V			KHS20-HPEW				SC33-LDH	
CS-871L			KRT12-5LM					
CS-872-3			KRT12-5BH					
CS-872L			KRT12-5LM					
CS-875-3, -5			SKRT12-5BK with Cap	KRT12-5BK hook only			SCP-8K	
CS-875L			SKRT12-5LMK with Cap	KRT12-5LMK hook only			SCP-LMK	
CS-8810			SKRT470-R with Cap	KRT470-R hook only			SCPF15	
CS-8810G			SKRT545FG with Cap	KRT545FG hook only			SCP545	
CS-8810H			SKRT470-RHB with Cap	KRT470-RHB hook only			SCPF15H	
CS-8812			SKRT545FG with Cap	KRT545FG hook only			SCP545	
CS-8812LM			KRT1971					
CS-8812M			SKRT470CT-R with Cap	KRT470CT-R hook only			SCPF441	
CS-8820			SKRT470-R with Cap	KRT470-R hook only			SCPF15	
CS-8820H			SKRT470-RHB with Cap	KRT470-RHB hook only			SCPF15H	
CS-8822LM			KRT1971					
CS-8900, -8901, -8902			SKRT390-HBG with Cap	KRT390-HBG hook only			SCPF15H	
CS-88H			KRT31-R					
CSA-3450-1/3/5			SH282					
CSA-3500			SH280				SC980-2	

SABUN INDUSTRIAL CO., LTD.

☆ = EXCLUSIVE ITEMS



GOLDEN WHEEL (金輪)

MACHINE (機器)	HOOK (梭梭)				BOBBIN CASE & CAP (梭壳 & 梭帽)		
	PART NO. (配件型号)	EX	KOBAN NO.1 (在文型号1)	KOBAN NO.2 (在文型号2)	PART NO. (配件型号)	EX	KOBAN NO. (在文型号)
CSA-6111D-LBFT			KRT1971				
CSH-7800			KRP41-LH2				SC70-771
CSL-1720			SKRT12-5-19R with Cap	KRT12-5-19R hook only			SCP18
CSL-1800, -1801			KRT132				
CSL-1810			KRT132-MT				
CSR-2401, H			SKRT470-R with Cap	KRT470-R hook only			SCPF15
CSU-4101			KRT12-5LMC				
CSU-4150			KRT12-5LMC-R				
CSU-4150BT			KRT12-5LMKC-CI				
CSU-4250			KRT12-5LMC-R				
CSU-4250BT			KRT12-5LMKC-CI				
CSZ-3211			KHS20-RST				SC34-L

HIGHLEAD (海菱)

MACHINE (機器)	HOOK (梭梭)				BOBBIN CASE & CAP (梭壳 & 梭帽)		
	PART NO. (配件型号)	EX	KOBAN NO.1 (在文型号1)	KOBAN NO.2 (在文型号2)	PART NO. (配件型号)	EX	KOBAN NO. (在文型号)
GA0688-1			KSP204N				
GA1398-1			KSP7-31				
GA2388-1, 2668-1, 2688-1, 2698-1			KSP204N				
GC0318-1, -2, -8, 0360-1, 0388			KHS20-RM2				SC33-L
GC0388-D			KHS20-RMP				SC33-LNS
GC0398-1			KHS20-RM2				SC33-L
GC0398-1D			KHS20-GTMP				SC33-LNS
GC0518			KHS12-SD				SC82-J
GC0518-1, -B			KHS20-RM2				SC33-L
GC0518-B-D			KHS20-GTMP				SC33-LNS
GC0518-H-D			KHS12-GTHPD				SC31-NS
GC0618, -1, -1-SC			KHS20-RM2				SC33-L
GC0918-1			KHS12-S				SC31
GC0918-1D			KHS12-SP				SC33-L
GC128-B			KHS20-RM2				SC33-LNS
GC128-B-D3			KHS20-GTMP				SC31
GC128-H			KHS12-R				SC31-NS
GC128-H-D3			KHS12-GTHPD				SC31
GC128-M			KHS12-S				SC33-L
GC128-M-D3			KHS12-SP				SC31
GC188-B			KHS20-RM2				SC31
GC188-H			KHS12-R				SC33-L
GC188-M, -MC			KHS12-S				SC31
GC188-MC-D, 1988-MD, -MDZ			KHS12-SP				SC31
GC2008-M			KHS12-S				
GC2008-MD			KHS12-SP				
GC20518-B			SKRT12-5LMK with Cap	KRT12-5LMK hook only			SCP-LMK
GC20518-B			KRT12-5M				
GC20518-B-D2			KRT12-5LMKC-CI				

SABUN INDUSTRIAL CO., LTD.

☆ = EXCLUSIVE ITEMS



HIGHLEAD (海菱)

MACHINE (机器)	HOOK (梭梭)				BOBBIN CASE & CAP (梭壳 & 梭帽)		
	PART NO. (配件型号)	EX	KOBAN NO.1 (日文型号1)	KOBAN NO.2 (日文型号2)	PART NO. (配件型号)	EX	KOBAN NO. (日文型号)
GC20518-M			KRT12-5M				
GC20528-B			SKRT12-5LMK with Cap	KRT12-5LMK hook only			SCP-LMK
GC20528-B-D2			SKRT12-5LMKC-1 with Cap	KRT12-5LMKC hook only			SCP-LMKC
GC20528-M			SKRT12-5MK with Cap	KRT12-5MK hook only			SCP-MK
GC20528-M-D3			SKRT12-5MC-2 with Cap	KRT12-5MC hook only			SCP-MKC
GC20618-1			KRT12-5LMC				
GC20618-1D			KRT12-5LMKC-CI				
GC20618-2			KRT12-5LMC				
GC20618-2D			KRT12-5LMKC-CI				
GC20638			SKRT12-5LMK with Cap	KRT12-5LMK hook only			SCP-LMK
GC20638-D			SKRT12-5LMKC-1 with Cap	KRT12-5LMKC hook only			SCP-LMKC
GC20698-1			KRT12-5LMC				
GC20698-1D			KRT12-5LMKC-CI				
GC20698-2			KRT12-5LMC				
GC20698-2D			KRT12-5LMKC-CI				
GC20698-5, -6			KRT14-5				
GC20818-MD			SKRT12-5MC-2 with Cap	KRT12-5MC hook only			SCP-MKC
GC22618			KRT31-11SG				
GC22618-1B			SKRT341G with Cap	KRT341G hook only			SCP545
GC2358-1			KHS20-RM2				SC33-L
GC24018, -1			KRT31-NR				
GC24098-BL			KRT8-LPS				
GC24518-1, -2			KRT31-NR				
GC24608-1L, -1R, -2			KRT8-LPS				
GC24618, -1			SKRT470-R with Cap	KRT470-R hook only			SCPF15
GC24698-1L, -1R			KRT31-11SG				
GC24698-BR			KRT8-LPS				
GC24818-1			KRT31-NR				
GC24896-2B			KRT8-LPS				
GC6-28-1			KHS12-S				SC31
GC6-28-1B			KHS20-RM2				SC33-L
GC6-28-1H			KHS12-R				SC31
HLV-18B			SKRT12-5LMK with Cap	KRT12-5LMK hook only			SCP-LMK

HUANAN (华南)

MACHINE (机器)	HOOK (梭梭)				BOBBIN CASE & CAP (梭壳 & 梭帽)		
	PART NO. (配件型号)	EX	KOBAN NO.1 (日文型号1)	KOBAN NO.2 (日文型号2)	PART NO. (配件型号)	EX	KOBAN NO. (日文型号)
GC0301-1, 0302			KHS12-SD				SC82-J
GC10-1, -1B, -1S			KHS12-S				SC31
GC10-1H, -1P			KHS12-R				
GC20505-1			SKRT842FK-S with Cap	KRT842FK-S hook only			SCP-842BC

SABUN INDUSTRIAL CO., LTD.

☆ = EXCLUSIVE ITEMS



HUANAN (華南)

MACHINE (機器)	HOOK (梭梭)				BOBBIN CASE & CAP (梭壳 & 梭帽)		
	PART NO. (配件型号)	EX	KOBAN NO.1 (日文型号1)	KOBAN NO.2 (日文型号2)	PART NO. (配件型号)	EX	KOBAN NO. (日文型号)
GC24010-1, 24011-1			KRT31-R				
GC24301-2			SKRT470-R with Cap	KRT470-R hook only			SCPF15
GC281, 28-1, 281B, 281H, 281P, 281S, 28-3, 28-3B, 28-3H, 28-3P, 28-3S, 48-1			KHS12-S				SC31
G16, -1			KRP41-LH				SC70-2

JACK (杰克)

MACHINE (機器)	HOOK (梭梭)				BOBBIN CASE & CAP (梭壳 & 梭帽)		
	PART NO. (配件型号)	EX	KOBAN NO.1 (日文型号1)	KOBAN NO.2 (日文型号2)	PART NO. (配件型号)	EX	KOBAN NO. (日文型号)
JK457			KRP457				SC70-3
JK5842-3			KRT842F-S				
JK5842-5			KRT12-5BH				
JK5842D-3							
JK5845-3			SKRT845BK with Cap	KRT845BK hook only			SCP-842BK
JK5845-5			SKRT845KC with Cap	KRT842KC hook only			SCP-842BKC
JK5872-3			KRT872L				
JK5872-5			SKRT872LC with Cap	KRT875LC hook only			SCP-LBC
JK5875-3			SKRT875LK with Cap	KRT875LK hook only			SCP-LBK
JK5875-5			SKRT872LC with Cap	KRT875LC hook only			SCP-LBC
JK6318			KHS20-R				SC33-L
JK781			KRP41-LH2				SC70-771
JK8500			KHS12-S				SC31
JK8500H			KHS12-GTH				
JK8900D			KHS12-SPD2				SC31-NS

JANOME (真善美)

MACHINE (機器)	HOOK (梭梭)				BOBBIN CASE & CAP (梭壳 & 梭帽)		
	PART NO. (配件型号)	EX	KOBAN NO.1 (日文型号1)	KOBAN NO.2 (日文型号2)	PART NO. (配件型号)	EX	KOBAN NO. (日文型号)
DB-J701, -J702, -J703, -J704	701-505-004		KHS12-S		761-511-009		SC31
DB-J705, -J706	703-504-009		KHS12-R				
DB-J706S	706-505-009		KHS20-R		706-506-000		SC33-L
DB-J707, -J708	701-505-004		KHS12-S				
TA-J761, -J763, -J766	761-510-008		KR21-G		761-511-009		SC31



JUKI (重机)

MACHINE (机器)	HOOK (梭梭)				BOBBIN CASE & CAP (梭壳 & 梭帽)			
	PART NO. (配件型号)	EX	KOBAN NO.1 (日文型号1)	KOBAN NO.2 (日文型号2)	PART NO. (配件型号)	EX	KOBAN NO. (日文型号)	
AMS-205C, -206C	B1818205000	☆	SH205		B18282050A0	☆	SC205	
	B1818280000		SH280					
AMS-205CHS, -206CHS	D18289800BB		SH282		B18289800BB		SC980-2	
AMS-210B,C	B1818205000	☆	SH205		B18282050A0	☆	SC205	
AMS-210D	B1818210DOA	☆	SH180JA		B1828210DAA	☆	SC180JHABK	
	B1818210DCB	☆	SH180JB					
AMS-210EN	40014954	☆	SH180JAH					
AMS-221EN/IP-420	40014955	☆	SH180JH					
AMS-211C, P	B1818205000	☆	SH205		B18282050A0	☆	SC205	
AMS-211CGS	B1818210000	☆	SH180J		B18282100A0	☆	SC180J	
AMS-212C, 215C	B1818205000	☆	SH205		B18282050A0	☆	SC205	
AMS-215CGS	B1818210000	☆	SH180J		B18282100A0	☆	SC180J	
AMS-215CHS	B1818205A0B	☆	SH205H2		B18282050AA	☆	SC205H	
AMS-215P	B1818215P00	☆	SH215		B1828215PA0	☆	SC215	
AMS-220B, CSS	B1818205000	☆	SH205		B18282050A0	☆	SC205	
AMS-220CGS	B1818210000	☆	SH180J		B18282100A0	☆	SC180J	
AMS-220CHS	B181820500B	☆	SH205H		B18282050A0	☆	SC205	
AMS-222B	B1818205000	☆	SH205					
AMS-222BG, CG	B1818210000	☆	SH180J		B18282100A0	☆	SC180J	
AMS-223CH	B1818205A0B	☆	SH205H2		B18282050A0	☆	SC205	
AMS-223CS	B1818205000	☆	SH205					
AMS-224CG	B1818210000	☆	SH180J		B18282100A0	☆	SC180J	
AMS-224CH	B1818205A0B	☆	SH205H2		B18282050A0	☆	SC205	
AMS-224CS	B1818205000	☆	SH205					
AMS-224E/IP-410	40061991	☆	SH180JCH		B1828210DAA	☆	SC180JHABK	
DDL-105	B18300120A0		KHS11-S					
DDL-115	B18300090A0		KR21-S		B18370120A0		SC31	
DDL-127	B18301270A0		KHS12-SJ2	KHS12-2S				
DDL-201	B18302010A0		KHS20-GTB		B18372010A0		SC33-L	
DDL-201S	B1830201SA0		KHS20-RTB					
DDL-5530	11038650		KHS12-SPOED2	KHS12-SPD2				
DDL-5530H	11092459		KHS12-SJH		11038759		SC31-NS	
DDL-5550H-6	11092551		KHS12-SPOED2H					
DDL-5550N, -5550, -5550N	B18301270A0		KHS12-SJ2	KHS12-2S	B18370120A0		SC31	
DDL-5550N-7	11038650		KHS12-SPOED2	KHS12-SPD2	D1837555BAA		SC31-NS	
DDL-5550NH	11092459		KHS12-SJH		B18370120A0		SC31	
DDL-5556N-WB DDL-5570, -5570N, -5571N, -5571NM, -5580N, -5581N	11038650		KHS12-SPOED2	KHS12-SPD2	D1837555BAA		SC31-NS	
DDL-5570M	D18305558A0		KHS12-SPD2					
DDL-5580H	D18304158AH		KHS12-GTHPD		B1837415DAL		SC82-JNS	
DDL-5600NJ, NL	B18302010A0		KHS20-GTB		B1837201SA0		SC33-LNS	
DDL-8100e DDL-8300, -8500	B18301270A0		KHS12-SJ2	KHS12-2S	B18370120A0		SC31	
DDL-8500-7	11038650		KHS12-SPOED2	KHS12-SPD2	D1837555BAA		SC31-NS	
DDL-8700	B18301270A0		KHS12-SJ2	KHS12-2S	B18370120A0		SC31	
DDL-8700-7	11038650		KHS12-SPOED2	KHS12-SPD2	D1837555BAA		SC31-NS	
	11141355		KHS12-SPOENPD2					
DDL-9000B/ DDL-9000SS	11038650		KHS12-SPOED2	KHS12-SPD2	D1837555BAA		SC31-NS	
	11141355		KHS12-SPOENPD2					
DDL-5430N	B18301270A0		KHS12-SJ2	KHS12-2S	B18370120A0		SC31	

SABUK INDUSTRIAL CO., LTD.

☆ = EXCLUSIVE ITEMS



JUKI (重机)

MACHINE (机器)	HOOK (旋梭)				BOBBIN CASE & CAP (梭壳 & 梭帽)		
	PART NO. (配件型号)	EX	KOBAN NO.1 (日文型号1)	KOBAN NO.2 (日文型号2)	PART NO. (配件型号)	EX	KOBAN NO. (日文型号)
DLD-5430N-7	11038650		KHS12-SPOED2	KHS12-SPD2	D18375558AA		SC31-NS
	11141355		KHS12-SPOENPD2				
DLM-5200, N, -5210N	B18301270A0		KHS12-SJ2	KHS12-2S	B18370120A0		SC31
DLM-5400N-7, -5420N-7	11038650		KHS12-SPOED2	KHS12-SPD2	D18375558AA		SC31-NS
	11141355		KHS12-SPOENPD2				
DLN-415, -5410N	B18304150A0		KHS12-SD		B18370410A0		SC82-J
DLN-5410N-7					B18392450A0		
DLN-9010	11038650		KHS12-SPOED2	KHS12-SPD2	40000264		SC31-NS
	11141355		KHS12-SPOENPD2				
DLN-9010SH	11092551		KHS12-SPOED2H		D18375558AA		
DLU-5490N	B18301270A0		KHS12-SJ2	KHS12-2S	B18370120A0		SC31
DLU-5490N-7, -5494N-7							
DMN-531-5, -5420N-7	11038650		KHS12-SPOED2	KHS12-SPD2	D18375558AA		SC31-NS
	11141355		KHS12-SPOENPD2				
DNU-1541	B1830241HA0		KHS20-HPEW		B1837241H00		SC33-LD
	B1830241SA0		KHS20-RPEM2A0		B1837241S00		
DNU-1541-7	D1830241EA0		KHS20-RMPNW		D1837141EA0		SC33-LNS3
DNU-241H	B1830241HA0		KHS20-HPEW		B1837241H00		SC33-LD
DNU-241HS	B1830241SA0		KHS20-RPEM2A0				
DNU-261H	B1830241HA0		KHS20-HPEW				
DSC-244/DSC-244-4/DSC-244-6	B18302450A0		KHS12-GTPND2		B18372450A0		SC82-JNS2
	21209952		KHS12-GTPN2D2		21210059		SC81-2NS2
DSC-245-4/DSC-245-5/DSC-245-6	B18302450A0		KHS12-GTPND2		B18372450A0		SC82-JNS2
DSC-246/DSC-246-4/DSC-246-6/DSC-246V/DSC-246V-4/DSC-246V-6	D1830141EA0		KHS20-RMPN		D1837141EA0		SC33-LNS3
	B1830241HA0		KHS20-HPEW		B1830241H00		SC33-LD
DSU-144, -4, -7	B1830141EA0		KHS20-RMPN		D1837141EA0		SC33-LNS3
DSU-144N	B1830201SA0		KHS20-RTB		B18372010A0		SC33-L
DSU-145-4, -7	D1830141EA0		KHS20-RMPN		D1837141EA0		SC33-LNS3
DU-140	21251053		KHS12-R		B18370120A0		SC31
DU-141H-7	D1830141EA0		KHS20-RMPN		21271556		SC33-LNS3
DU-580	B1830141HA0		KHS20-RM3				
LBH-1700, -1790	13729066	☆	KRP791	KRP41-LH3ICC			
LBH-761, -762, -763	B18087610AB		KRP41-LH		B18107610A0		SC70-2
LBH-771, -772, -773, -781, -782, -783, -784	B18087710AC	☆	KRP771	KRP41-LH2	B181077108A		SC70-771NS
LBH-791, -791S, -792, -792S, -793, -793S, -794, -794S	13729066	☆	KRP791	KRP41-LH3ICC			
LG-158, -158-1, -57	B1830057SA0		KRT14-5HP				
LH-1150	10110104		SKRT12-5J with Cap	KRT12-5J hook only	10110252		SCP-JC
	10197655		KRT12-5JI				
LH-1150-4, -5, -6	10110062		SKRT12-5JC with Cap	KRT12-5JC hook only	10110252		SCP-JC
LH-1152	10110104		SKRT12-5J with Cap	KRT12-5J hook only			
	10197655		KRT12-5JI				
LH-1152-4, -5, -6	10110062		SKRT12-5JC with Cap	KRT12-5JC hook only	10110252		SCP-JC
	10195154		KRT12-5JCI				

SABUN INDUSTRIAL CO., LTD.

☆ = EXCLUSIVE ITEMS



JUKI (重机)

MACHINE (机器)	HOOK (梭梭)				BOBBIN CASE & CAP (梭壳 & 梭帽)		
	PART NO. (配件型号)	EX	KOBAN NO.1 (日文型号 1)	KOBAN NO.2 (日文型号 2)	PART NO. (配件型号)	EX	KOBAN NO. (日文型号)
LH-1160, -1162	10207967		SKRT12-5JK-L1 with cap	KRT12-5JK-L hook only	10208254		SCP-JKC
	10208064		SKRT12-5JK-R1 with cap	KRT12-5JK-R hook only			
LH-1160-4, -5, -6 LH-1162-4, -5, -6	10207769		SKRT12-5JKC-L1 with cap	KRT12-5JKC-L hook only			
	10207868		SKRT12-5JKC-R1 with cap	KRT12-5JKC-R hook only			
LH-1172	10353761		SKRT11-5LLJ-R with cap	KRT11-5LLJ-R hook only	10353555		SCP-LLJ
	10353860		SKRT11-5LLJ-L with cap	KRT11-5LLJ-L hook only			
LH-1172-4, -5, -6	10353068		SKRT11-5LLJC-R with cap	KRT11-5LLJC-R hook only			
	10353167		SKRT11-5LLJC-L with cap	KRT11-5LLJC-L hook only			
LH-1178, -6	10697084	☆	KRT2182I				
LH-1180, -1182	10232965		SKRT12-5LJK2-L1 with cap	KRT12-5LJK2-L hook only	10353553		SCP-LJKC
	10233062		SKRT12-5LJK2-R1 with cap	KRT12-5LJK2-R hook only			
LH-1180-4, -5, -6 LH-1182-4, -5, -6	10231066		SKRT12-5LJKC-L1 with cap	KRT12-5LJKC-L hook only			
	10231165		SKRT12-5LJKC-R1 with cap	KRT12-5LJKC-R hook only			
LH-2172, -6	10612752 W/CAP	☆	SKRT2172F with Cap	☆ KRT2172F hook only	10612554		SCP2172
LH-2182, -6	10634756 W/CAP	☆	SKRT2182 with Cap	☆ KRT2182 hook only	10634657		SCP2182
	10697084	☆	KRT2182I				
LH-3120A, F, -3128	22612055		KRT842F-S				
LH-3128	22612758		SKRT842FK-S with Cap	KRT842FK-S hook only	22612659		SCP-8428C
LH-3128-7	22653059		KRT30JC				
	22653158		KRT30JCI				
LH-3128-7, -3162-4, -7	22693857		SKRT30JJC with Cap	KRT30JC hook only	22688154		SCP-8428K
LH-3168, -3168-7	22688253		SKRT845BK with Cap	KRT845BK hook only			
	22693857		SKRT30JJC with Cap	KRT30JC hook only			
LH-3178	22813455		KRT872L		22819650		SCP-LBC(J)
	22814255		SKRT30LJ with Cap	KRT30LJ hook only			
	22827158		SKRT30LJK with Cap	KRT30LJ hook only			
LH-3178-7	22819452		SKRT30LJC with Cap	KRT30LJC hook only	22819650		SCP-LBC(J)
	22831259		SKRT30LJJC with Cap	KRT30LJC hook only			
LH-3188	22814255		SKRT30LJ with Cap	KRT30LJ hook only	22819650		SCP-LBC(J)
	22827158		SKRT30LJK with Cap	KRT30LJ hook only			

SABUN INDUSTRIAL CO., LTD.

☆ = EXCLUSIVE ITEMS



JUKI (重机)

MACHINE (机器)	HOOK (梭梭)				BOBBIN CASE & CAP (梭壳 & 梭帽)		
	PART NO. (配件型号)	EX	KOBAN NO.1 (日文型号1)	KOBAN NO.2 (日文型号2)	PART NO. (配件型号)	EX	KOBAN NO. (日文型号)
LH-3188-7	22814255		SKRT30LJ with Cap	KRT30LJ hook only	22819650		SCP-LBC(J)
	22831259		SKRT30LJKC with Cap	KRT30LJC hook only	22827257		SCP-LBKC(J)
LH-3500 SERIES	40036682	☆	KRT35JI				
	40036683	☆	KRT35JCI				
	40036684	☆	SKRT35JK with Cap	☆ KRT35JK Hook only	22688154		SCP35JKC
	40036685	☆	SKRT35JKC with Cap	☆ KRT35JKC Hook only			
	40091143	☆	KRT35AJI				
	40091144	☆	SKRT35AJK with Cap	☆ KRT35AJK Hook only	22688154		SCP35JKC
LH-3578A, -7, 3588A, -7	40043333	☆	KRT35LJI				
	40043334	☆	KRT35LJCI				
	40043335	☆	SKRT35LJK with Cap	☆ KRT35LJK Hook only	22827257		SCP-LBKC(J)
	40043336	☆	SKRT35LJKC with Cap	☆ KRT35LJKC Hook only			
LH-4128, -7, -4168-7, -4188-7	40013786	☆	KRT40JCI				
LH-512, -515	B18305120A0		KRT21				
LH-512H, -515H	B18305120AH		KRT21-R				
LH-527	B18305210A0		SKRT11-5LJKS with Cap	KRT11-5LJKS hook only	B18375260A0		SCP-LJK
LH-528	B18305280A0		SKRT21-K with Cap	KRT21-K hook only	B18375280A0		SCP-MK
LK-1850, -1850C, -1851, -1851C	B1818280000		SH280		B18269800A0		SC980N
	B181828000A		SH280T				
LK-1850J	D1818282N00		SH282				
LK-1900	B1818280000		SH280		B18269800BB		SC980-2
	D1818282N00		SH282				
LK-1900A	4006580	☆	SH280H		B18269800BB		SC980-2
	4006581	☆	SH282H				
	40014965	☆	SH180JH			B1826210DAA	
LK-1910, -1920, -1930	B1818210D0A	☆	SH180JA		B1826210DAA	☆	SC180JHABK
	B1818210D0B	☆	SH180JB				
LK-1952, -1953, -1954	13876305	☆	SH180J2		B18262100A0	☆	SC180J
LK-980	B1818280000		SH280		B18269800A0		SC980N
	B1801340000		KRT31-11SG				
LS-1340/LS-1341	21229752		SKRT341-NR with Cap	KRT341-NR hook only	21229307		SCP545
	21435854		KRT341-NCI-R				
LS-1342-7	21441347		KRT341-NCI-S				
LS-311	B18303110A0		KRT341GI				
LS-321	21228051		SKRT341G with Cap	KRT341G hook only	21229356		SCP545
	21245055		SKRT341SG with Cap	KRT341SG hook only			
LS-341N	21229752		SKRT341-NR with Cap	KRT341-NR hook only			



JUKI (重機)

MACHINE (機種)	HOOK (梭梭)				BOBBIN CASE & CAP (梭壳 & 梭帽)		
	PART NO. (配件型号)	EX	KOBAN NO.1 (在文型号1)	KOBAN NO.2 (在文型号2)	PART NO. (配件型号)	EX	KOBAN NO. (在文型号)
LU-1114-4, -5, -6, -7	10353068		SKRT11-5LLJC-R with cap	KRT11-5LLJC-R hook only	10353555		SCP-LLJ
	10353076		KRT11-5LLJC-R				
LU-1508N/1508NH	B18305630A0		KRT11-5LJS				
	B18305638A0		KRT11-5LJR				
LU-1508NS	B18305630A0		KRT11-5LJS				
LU-1509N	21387055	☆	KRT150LJCIV				
	B18305630A0		KRT11-5LJS				
	B18305638A0		KRT11-5LJR				
LU-1510N	B18305630A0		KRT11-5LJS				
LU-1510N-7/LU-1510NA-7	21387055	☆	KRT150LJCIV				
LU-1560N/1560N-7 LU-1561N/1561N-7	B18305630A0		KRT11-5LJS				
LU-1565N	B18305210A0		SKRT11-5LJKS with Cap	KRT11-5LJKS hook only	B18375260A0		SCP-LJK
LU-2210N-7 / LU-2212N-7 / LU-2216N-7 / LU-2220N-7 / LU- 2260N-7 / 2266N-7	10761252		KRT467J				
LU-562N	B18305630A0		KRT11-5LJS				
LU-563-3	B18305638A0		KRT11-5LJR				
LU-563N	B18305630A0		KRT11-5LJS				
LUH-521	B1830521HA0		SKRT11-5LJKR with Cap	KRT11-5LJKR hook only	B18375210A0		SCP-LJ
LUH-526	B18305210A0		SKRT11-5LJKS with Cap	KRT11-5LJKS hook only	B18375260A0		SCP-LJK
LZ-271/LZ-391N	B18307100A0		KR23-16		B18370270A0		SC35
	B18300270A0		KR23-16-2				
LZ-582 ~ 586	B18305810A0		KHS11S-58		B18375820A0		SC35-NS
LZH-1290/LZH-1290-4/LZH-1290-6	10078954	☆	KHS20-RT		10080059		SC34-LZNS
LZ-2290A-SR, SS, SU	22525877		KRP457TICC		23537459		
PLH-981, -982, -985, -986	21010251		KRT31-NR				
PLW-1245, -4, -6	10549855		SKRT470C-R with Cap	KRT470C-R hook only	10545358		SCPF441
PLW-1246	10522852		SKRT470-R with Cap	KRT470-R hook only	10547651		SCPF15
PLW-1246, -4, -6	10549855		SKRT470C-R with Cap	KRT470C-R hook only	10545358		SCPF441
TNU-243 TSC-441, -461 TSH-411 TSN-421 TSU-471 TU-273	21041850		KSP204N				



JUMBO KING (象王)

MACHINE (机器)	HOOK (筘梭)				BOBBIN CASE & CAP (梭壳 & 梭帽)		
	PART NO. (配件型号)	EX	KOBAN NO.1 (日文型号1)	KOBAN NO.2 (日文型号2)	PART NO. (配件型号)	EX	KOBAN NO. (日文型号)
WR-1130			KHS12-R				SC31
WR-204			KSP204				
WR-204-370, -205, -205-370			KSP204N				
WR-3358B, -3358BL, -335A, -3358			KR24-RHPD				SC34-1
WR-341			SKRT341G with Cap	KRT341G hook only			SCP545
WR-3750			KHS20-RM2				SC33-L
WR-3750T			KHS20-RMP				SC33-LNS
WR-3811			KHS20-R				SC33-L
WR-467			KRT467				
WR-5705			KHS20-R				SC33-L
WR-652			KR24-B				SC34-1
WR-810, -820			KRT31-NR				
WR-842-5			KRT12-5M				
WR-971T, -972T			KRT1971				
WR-981, -BT, -BTS, -MBT, -MBTS, -MT, -MTS, -NBT, -NBTS, -NT, -NTS, -T, -TS	991-332		SKRT470C2-R with cap	KRT470C2-R hook only			SCPF441
WR-981, -M, -N	991-244		SKRT470-R with cap	KRT470-R hook only			SCPF15
WR-981-MX2BTSE, -NX2BTSE, -NX2TS	991-332-X2	☆	KRT470LCI-R				
WR-981-X2, -MX2, -NX2	991-244-X2	☆	KRT470LI-R				
WR-982, -BT, -BTS, -MBT, -MBTS, -MT, -MTS, -NBT, -NBTS, -NT, -NTS, -T, -TS	991-332		SKRT470C2-R with cap	KRT470C2-R hook only			SCPF441
WR-982, -M, -N	991-244		SKRT470-R with cap	KRT470-R hook only			SCPF15
WR-982-MX2BTS, -NX2BTS, -NX2TS	991-332-X2	☆	KRT470LCI-R				
WR-982-X2, -MX2, -NX2	991-244-X2	☆	KRT470LI-R				
WR-9910-B, -BT WR-9920-B, -BT	991-244		SKRT470-R with cap	KRT470-R hook only			SCPF15
WR-9910-DMT, -T, -991T, -9920DMT, -9920-T			SKRT470C-R with cap	KRT470C-R hook only			SCPF441
WR-9910-H, -9920-H			SKRT470-RHH with Cap	KRT470-RH hook only			SCPF441H
WR-998-A, -B, -C, -D	991-244		SKRT470-R with cap	KRT470-R hook only			SCPF15
998-CS, -DS	998(S)		SKRT47MIN with Cap	KRT47MIN hook only			SCP31MIN

K-CHANCE (高機)

MACHINE (机器)	HOOK (筘梭)				BOBBIN CASE & CAP (梭壳 & 梭帽)		
	PART NO. (配件型号)	EX	KOBAN NO.1 (日文型号1)	KOBAN NO.2 (日文型号2)	PART NO. (配件型号)	EX	KOBAN NO. (日文型号)
KBH-780			KRP41-LH2				SC70-771

SABUN INDUSTRIAL CO., LTD.

☆ = EXCLUSIVE ITEMS

**KERDER (客德)**

MACHINE (机器)	HOOK (旋梭)				BOBBIN CASE & CAP (梭壳 & 梭帽)		
	PART NO. (配件型号)	EX	KOBAN NO.1 (日文型号1)	KOBAN NO.2 (日文型号2)	PART NO. (配件型号)	EX	KOBAN NO. (日文型号)
KD-20U			KR24U-42				SC35
KD-810			KRT31-R				
KD-8100-3			KHS12-S				SC31
KD-8100-5, -7			KHS12-R				
KD-820			KRT31-R				

KING'S (王品)

MACHINE (机器)	HOOK (旋梭)				BOBBIN CASE & CAP (梭壳 & 梭帽)		
	PART NO. (配件型号)	EX	KOBAN NO.1 (日文型号1)	KOBAN NO.2 (日文型号2)	PART NO. (配件型号)	EX	KOBAN NO. (日文型号)
HC-335			KR24-B				SC35
HC-471, -474, -491			SKRT470-R with Cap	KRT470-R hook only			SCPF15
HC-616, -618			SKRT545 with Cap	KRT545 hook only			SCP545
HC-810, -815, -820, -825			KRT31-R				
HC-832			KRT12-5M				
HC-835			KRT12-5LM				
HC-919, -929			KRT31-R				

KINGTEX (精機)

MACHINE (机器)	HOOK (旋梭)				BOBBIN CASE & CAP (梭壳 & 梭帽)		
	PART NO. (配件型号)	EX	KOBAN NO.1 (日文型号1)	KOBAN NO.2 (日文型号2)	PART NO. (配件型号)	EX	KOBAN NO. (日文型号)
KL-300H, -300M			KHS12-S				SC31
KL-300M-A			KHS12-SPD2				SC31-NS
KL-310M, -500M			KHS12-S				SC31

MEIJA (美佳)

MACHINE (机器)	HOOK (旋梭)				BOBBIN CASE & CAP (梭壳 & 梭帽)		
	PART NO. (配件型号)	EX	KOBAN NO.1 (日文型号1)	KOBAN NO.2 (日文型号2)	PART NO. (配件型号)	EX	KOBAN NO. (日文型号)
G15-2			KR24				SC35
GG70701			KHS12-RY				SC35-NS

MELCO

MACHINE (机器)	HOOK (旋梭)				BOBBIN CASE & CAP (梭壳 & 梭帽)		
	PART NO. (配件型号)	EX	KOBAN NO.1 (日文型号1)	KOBAN NO.2 (日文型号2)	PART NO. (配件型号)	EX	KOBAN NO. (日文型号)
EMC 1, EMC 10/12, EMT 10/4T, EMT 10T			KHS12-RY				SC35-NS
			KHS12-RYP				

SABUN INDUSTRIAL CO., LTD.

☆ = EXCLUSIVE ITEMS



MILLION SPECIAL (萬特)

MACHINE (機種)	HOOK (梭梭)				BOBBIN CASE & CAP (梭壳 & 梭帽)			
	PART NO. (配件型号)	EX	KOBAN NO.1 (在文型号1)	KOBAN NO.2 (在文型号2)	PART NO. (配件型号)	EX	KOBAN NO. (在文型号)	
MS-1245			SKRT1242-R hook with cap	KRT1242-R hook only			SCP545	
MS-1341			SKRT341G with Cap	KRT341G hook only				
MS-20U, -20U143			KR24U-42				SC35	
MS-335, -335N			KR24-B				SC33-L	
MS-370L, -3811L			KHS20-R				SCP545	
MS-474-500			SKRT470-R with Cap	KRT470-R hook only			SCP545	
MS-474-510, -530, -530P			SKRT470C-R with Cap	KRT470C-R hook only			SCP545	
MS-491-800			SKRT470-R with Cap	KRT470-R hook only			SCP545	
MS-491-810, -830, -830P			SKRT470C-R with Cap	KRT470C-R hook only			SCP545	
MS-652			KR24-B				SC35	
MS-674D-500			SKRT470-R with Cap	KRT470-R hook only			SCP545	
MS-674D-510, -530, -530P			SKRT470C-R with Cap	KRT470C-R hook only			SCP545	
MS-674DL-510			SKRT470LC-R with Cap	KRT470LC-R hook only			SCP545	
MS-691D-800			SKRT470-R with Cap	KRT470-R hook only			SCP545	
MS-691D-810, -830, -830P			SKRT470C-R with Cap	KRT470C-R hook only			SCP545	
MS-691DL-810			SKRT470LC-R with Cap	KRT470LC-R hook only			SCP545	
MS-735			KHS12-S				SC31	
MS-810			KRT31-NR					
MS-810-H			KRT31-RGH					
MS-820			KRT31-NR					
MS-8652			KR24-B				SC35	
MS-8735R			KHS12-S				SC31	
MS-8842, -8842-3			KRT12-5M					
MS-8842-403, -405			KRT12-5BFCI					
MS-8842-5			KRT12-5LM					
MS-8845, -3, -5			SKRT12-5MK with Cap	KRT12-5MK hook only			SCP-MK	
MS-8872, -3			KRT12-5LM					
MS-8872-403, -405			SKRT872LC with Cap	KRT875LC hook only			SCP-LBC	
MS-8872-5			KRT12-5LM					
MS-8875, -5			SKRT12-5LMK with Cap	KRT12-5LMK hook only			SCP-LMK	
MS-8875-3, -403, -405			SKRT875LKC with Cap	KRT875LC hook only			SCP-LBKC	



MITSUBISHI (三菱)

MACHINE (机器)	HOOK (梭梭)				BOBBIN CASE & CAP (梭壳 & 梭帽)		
	PART NO. (配件型号)	EX	KOBAN NO.1 (在文型号1)	KOBAN NO.2 (在文型号2)	PART NO. (配件型号)	EX	KOBAN NO. (在文型号)
CU-865-12	MF6580120		KR21-R		MF10E0125		SC31
CU-865-22FP	MF2580120		KHS20-RM2		MF25E0125		SC33-L
DB-130-10	MF16A0120		KHS12-S		MF10E0125		SC31
DB-130-12	MF42A0120		KHS12-R				
DB-130-22	MF2580120		KHS20-RM2		MF25E0125		SC33-L
DB-320-10	MF60A0120		KR21-S		MF10E0125		SC31
DN-350-12	MN30A0120		KR21-RD				
DY-253	MG23E0121		KRT132				
DY-340-22	MG44B0120		KHS20-RMP		MG44E0125		SC33-LNS
DY-340-22BZ	MG44B0120		KHS20-RMP		MG44E0125		SC33-LNS
DY-350-12	MF2280120		KHS12-R		MF10E0125		SC31
DY-350-22	MF2580120		KHS20-RM2		MF25E0125		SC33-L
DY-359-22	MG44B0120		KHS20-RMP				
DY-359-22BZ	ME20A0120				MG44E0125		SC33-LNS
LG2-3370-M, -M1T	MF40A0120		KHS12-SP		MF40E0125		SC31-NS
LS2-1130-B, -BOB, -HOB	MF2580120		KHS20-RM2		MF25E0125		SC33-L
LS2-1130-MOB	MF16A0120		KHS12-S		MF10E0125		SC31
LS2-1180-H	MF4280120		KHS12-GTHPD		MF40E0125		SC31-NS
LS2-1180-L1T, -M1T, M1TW	MF40A0120		KHS12-SP		MF40E0125		SC31-NS
LS2-1280-B1T	MF2580120		KHS20-RM2		MF25E0125		SC33-L
LS2-1280-H1TW	MF42A0120		KHS12-R		MF10E0125		SC31
LS2-1280-M, -M1T	MF40A0120		KHS12-SP		MF40E0125		SC31-NS
LS2-130-BOB	MF2580120		KHS20-RM2		MF25E0125		SC33-L
LS2-130-HOB	MF2280120		KHS12-R		MF10E0125		SC31
LS2-1380-M1T	MF40A0120		KHS12-SP		MF40E0125		SC31-NS
LS2-150-MOB	MF16A0120		KHS12-S		MF10E0125		SC31
LS2-1780-M1TW	MF00A0120		KHS12-SP		MN40E0125		SC31-NS
LS2-180	MF45A0120		KHS20-GTMP		MG44E0125		SC33-LNS
LS2-2210-M	MF40A0120		KHS12-SP				
LS2-2210-M1T, -M1TW	MN35A0120		KHS12-SPD2		MN35A0125		SC82-JNS
LT2-2220-BOB	MN1280120		KRT12-5LM				
LT2-2220-MOB	MN10A0120		KRT12-5M				
LT2-2230-B1T	MN74E0120		KRT12-5LMKCI				
LT2-2230-M, -M1TW	MN72E0120		KRT12-5MCI				
LT2-2240-BOB	MN2680120		SKRT12-5LMK with Cap	KRT12-5LMK hook only			SCP-LMK
LT2-2240-MOB	MN25A0120		SKRT12-5MK with Cap	KRT12-5MK hook only			SCP-MK
LT2-2250-B1T	MN62E0120		SKRT12-5LMKC-1 with Cap	KRT12-5LMKC hook only			SCP-LMKC
LT2-2250-M1TW	MN60E0120		SKRT12-5MC-1 with Cap	KRT12-5MC hook only	MN60A0125		SCP-MC
LU2-400-BOB	MP00A0120		KRT12-5LMC				
LU2-410-B1T	MP43A0120		KRT12-5LMKC-CI				
LU2-420-BOB	MP00A0120		KRT12-5LMC				
LU2-430	MP43A0120		KRT12-5LMKC-CI				
LU2-430-B1T	MN52E0120		SKRT12-5LMKC-C with Cap	KRT12-5LMKC-C hook only	MN52E0125		SCP-LMC
LU2-4400	MP00A0120		KRT12-5LMC				
LU2-4410-B	MP43A0120		KRT12-5LMKC-CI				
LU2-4410-B1T	MN52E0120		SKRT12-5LMKC-C with Cap	KRT12-5LMKC-C hook only	MN52E0125		SCP-LMC

SABUN INDUSTRIAL CO., LTD.

☆ = EXCLUSIVE ITEMS



MITSUBISHI (三菱)

MACHINE (机器)	HOOK (钩梭)				BOBBIN CASE & CAP (梭壳 & 梭帽)		
	PART NO. (配件型号)	EX	KOBAN NO.1 (日文型号1)	KOBAN NO.2 (日文型号2)	PART NO. (配件型号)	EX	KOBAN NO. (日文型号)
LU2-4412-B1T	MP43A0120		KRT12-5LMKC-CI				
LU2-4420	MP00A0120		KRT12-5LMC				
LU2-4430-B1T, -4650-B1T, -4652-B1T, -4710-B1T, -4730-B1T	MP43A0120		KRT12-5LMKC-CI				
LU3-6860			KRT341GI				
LX2-371-MO	MF60A0120		KR21-S				SC31
LX2-630-M1	MN50E0120		SKRT12-5MC-2 with Cap	KRT12-5MC hook only			SCP-MKC
LX5-871-MO	MQ70A0120		SKRT190G with Cap	KRT190G hook only			SCPF19
LY2-3300-BOB	ME20A0120		KHS20-RMP		MG44E0125		SC33-LNS
LY3-6840-BOT							
PLK-03BTA	MS01A0120		SH430				
PLK-0504, -0604	MS01A1120		SH430-H		MS01A0125		SC430
PLK-0804	MS01A0120		SH430				
PLK-1210, -1410	ME20A0120		KHS20-RMP		MG44E0125		SC33-LNS
PLK-A2016	MA10A0120		SH181		MS17A0125		SC181
PLK-A3530 PLK-A4516	MS10A1120		SH181H		MS17A1125		SC181H
PLK-E03BT	MS01A0120		SH430				
PLK-E03BTA	MS01A1120		SH430-H		MS01A0125		SC430
PLK-E0504	MS01A0120		SH430				
PLK-E5050, -E10050	MA10A0120		SH181		MS17A0125		SC181
PLK-E1008H	MB18A0120		KSP204N				
PLK-E1010	MA10A0120		SH181		MS17A0125		SC181
PLK-E2008H	MB18A0120		KSP204N				
PLK-E2010R	ME20A0120		KHS20-RMP		MG44E0125		SC33-LNS
PLK-E2516	MA10A0120		SH181		MS17A0125		SC181
PLK-E2516A, -E2516R	ME20A0120		KHS20-RMP		MG44E0125		SC33-LNS
PLK-E4030, -E4519, -E5050, -E6019, -E6030	MA10A0120		SH181		MS17A0125		SC181
PLK-E7191, -E7194, -E7203	MN62E0120		SKRT12-5LMKC-2 with Cap	KRT12-5LMKC hook only			SCP-LMC
PLK-E10050	MA10A0120		SH181		MS17A0125		SC181
PLY-1185	MN62E0120		SKRT12-5LMKC-2 with Cap	KRT12-5LMKC hook only			SCP-LMC
PLY-501F	MN26B0120		SKRT12-5LMK with Cap	KRT12-5LMK hook only			SCP-LMK
PLY-7181, 7182, 7191, 7194, 7202, 7203	MN62E0120		SKRT12-5LMKC-2 with Cap	KRT12-5LMKC hook only			
PLY-7206	MN52E0120		SKRT12-5LMKC-C with Cap	KRT12-5LMKC-C hook only	MN52E0125		SCP-LMC
PLY-7206E	MN62E0120		SKRT12-5LMKC-2 with Cap	KRT12-5LMKC hook only			



NECCHI (尼奇)

MACHINE (机器)	HOOK (旋梭)				BOBBIN CASE & CAP (梭壳 & 梭帽)		
	PART NO. (配件型号)	EX	KOBAN NO.1 (佐文型号1)	KOBAN NO.2 (佐文型号2)	PART NO. (配件型号)	EX	KOBAN NO. (佐文型号)
533, 535, 720, 721			KR24				SC35
800, 801, 803, 810, 813	522514		KR21-S				SC31
B40			KR24				SC35
RM, RVG, RVM, UAN-1501	522514		KR21-S				SC31

NITAKA (日高)

MACHINE (机器)	HOOK (旋梭)				BOBBIN CASE & CAP (梭壳 & 梭帽)		
	PART NO. (配件型号)	EX	KOBAN NO.1 (佐文型号1)	KOBAN NO.2 (佐文型号2)	PART NO. (配件型号)	EX	KOBAN NO. (佐文型号)
DY-3300, -350, -350L, -370L, -3810, -3811-L, -3812-L			KHS20-R				SC33-L
TC-1341			SKRT341-NR with Cap	KRT341-NR hook only			SCP545
TC-1508			KRT-LS2R				
TC-1530			KHS20-R				SC33-L
TC-2508			KRT-LS2R				
TC-2530			KHS20-R				SC33-L
TC-28, -28B, -28B, -2898			KRT-LS2R				
TC-28BL, -28L, -2898L, -2898L			KRT8-LC-RB-CS				
TC2-81883			SKRT12-5MK3 with Cap	KRT12-5MK hook only			SCP-MK3
TC2-81885			SKRT12-5LMK with Cap	KRT12-5LMK hook only			SCP-LMK
TC2-8842			KRT12-5M				
TC2-8842-40			KRT12-5BFCI				
TC2-8845			SKRT12-5MK3 with Cap	KRT12-5MK hook only			SCP-MK3
TC2-8845-40			KRT12-5BFCI				SCP-842BC
TC2-8872			KRT12-5LM				
TC2-8872-40			KRT12-5LMKCI				
TC2-8875			SKRT12-5LMK2 with Cap	KRT12-5LMK hook only			SCP-LMKC2
TC2-8935			KRT12-5LM				
TC-3370			KHS20-R				SC33-L
TC-341			SKRT341G with Cap	KRT341G hook only			SCP545
TC-341L			KRT341-NHI				
TC-360-1, -2, -3, -4			SKRT391 with Cap	KRT391 hook only			SCPF15H
TC-360-5, -6, -7, -8, -9, -10, -12, -13, -14, -15, -360L			SKRT341G with Cap	KRT341G hook only			SCP545
TC-360-11			SKRT151M0 with Cap	KRT151M0 hook only			SCP151M0
TC-3810			KHS20-R				SC33-L
TC-8			KRT-LS2R				

SABUR INDUSTRIAL CO., LTD.

☆ = EXCLUSIVE ITEMS



NITAKA (日高)

MACHINE (机器)	HOOK (钩梭)				BOBBIN CASE & CAP (梭壳 & 梭帽)		
	PART NO. (配件型号)	EX	KOBAN NO.1 (日文型号1)	KOBAN NO.2 (日文型号2)	PART NO. (配件型号)	EX	KOBAN NO. (日文型号)
TC-810, -810S, -820, -820S			KRT31-NR				
TC-8360, -8361, -8367			SKRT391 with Cap	KRT391 hook only			SCPF15H
TC-8370			SKRT341G with Cap	KRT341G hook only			SCP545
TC-8370L			KRT341-NHI				
TC-8371			SKRT341G with Cap	KRT341G hook only			SCP545
TC-8371L			KRT341-NHI				
TC-8372			SKRT341G with Cap	KRT341G hook only			SCP545
TC-8372L			KRT341-NHI				
TC-8410, -8411			KRT31-NR				
TC-841-22			KRT12-5LM				
TC-8420, -8422, -8450			KRT31-NR				
TC-847-5 TC-872 TC-877-4			KRT12-5LM				
TC-88			KRT-LS2R				
TC-881, -882			SKRT470-R with Cap	KRT470-R hook only			SCPF15
TC-8855, -8856, -8865, -8866			SKRT391 with Cap	KRT391 hook only			SCPF15H
TC-8872			SKRT341G with Cap	KRT341G hook only			SCP545
TC-8872L			KRT341-NHI				
TC-888			KRT-LS2R				
TC-888L, -88L			KRT8-LC-RB-CS				
TC-88			KRT-LS2R				
TC-88L			KRT8-LC-RB-CS				
TC-9255, -9256, -9365, -9366			SKRT391 with Cap	KRT391 hook only			SCPF15H
TC-9410, -9411			KRT31-NR				
TC-9510			SKRT341G with Cap	KRT341G hook only			SCP545
TC-9510L			KRT341-NHI				
TC-9511			SKRT341G with Cap	KRT341G hook only			SCP545
TC-9511L			KRT341-NHI				
TC-9520			SKRT341G with Cap	KRT341G hook only			SCP545
TC-9520L			KRT341-NHI				
TC-8842-403, -405			KRT12-5BFCI				
TC-8872-403, -405			KRT12-5LMKCI				
TCC-8841, -88423, -8847-3, -8877-3			KRT12-5M				
TDY-3811L, -3812L			KHS20-R				SC33-L
TTC-1550			KHS12-SB2K				SC31
TTC-15506			KHS12-R				SC31
TTC-3750			KHS20-R				SC33-L
TTC-3750L			KHS20-HPEW				SC33-LD
YU-380L							

**PANDA (建聯)**

MACHINE (機器)	HOOK (旋梭)				BOBBIN CASE & CAP (梭壳 & 梭帽)		
	PART NO. (配件型号)	EX	KOBAN NO.1 (日文型号1)	KOBAN NO.2 (日文型号2)	PART NO. (配件型号)	EX	KOBAN NO. (日文型号)
JL-20U			KR24U-42				SC35
JL-457A			KRP457-W				SC70-3
JL-781			KRP41-LH2				SC70-771

PEGASUS (飛馬)

MACHINE (機器)	HOOK (旋梭)				BOBBIN CASE & CAP (梭壳 & 梭帽)		
	PART NO. (配件型号)	EX	KOBAN NO.1 (日文型号1)	KOBAN NO.2 (日文型号2)	PART NO. (配件型号)	EX	KOBAN NO. (日文型号)
DPS-2, -3, -4	179077000009		KRP41-S				SC70-2

PEMAL (良機)

MACHINE (機器)	HOOK (旋梭)				BOBBIN CASE & CAP (梭壳 & 梭帽)		
	PART NO. (配件型号)	EX	KOBAN NO.1 (日文型号1)	KOBAN NO.2 (日文型号2)	PART NO. (配件型号)	EX	KOBAN NO. (日文型号)
CDL-1388N			KHS12-R				SC31
CDL-5550N			KHS12-S				
LT2-8842-3			KRT12-5M				
LT2-8845-3			KRT12-5LM				
LT2-8872			KRT12-5M				
LT2-8875			KRT12-5LM				
PM-1828, -1836, -1850			SH280				SC980N
PM-780			KRP41-LH				SC70-2

PFAFF (百福)

MACHINE (機器)	HOOK (旋梭)				BOBBIN CASE & CAP (梭壳 & 梭帽)		
	PART NO. (配件型号)	EX	KOBAN NO.1 (日文型号1)	KOBAN NO.2 (日文型号2)	PART NO. (配件型号)	EX	KOBAN NO. (日文型号)
114, 115, 116	91-008250-91W/O BC		KRP3114		91-008243-91		SC70-31
1181, 1183	91-262250-91		KHS1183-SP				
120, 122	91-010165-91W/CAP		SKRT151S with Cap	KRT151S hook only	91-010159-91		SCPF15
1240C/D	91-018340-91W/CAP		SKRT545 with Cap	KRT545 hook only			
1241 ~ 1246	91-140539-91W/O CAP		SKRT1242-R hook with cap	KRT1242-R hook only			
1242-720/1242- 748	91-140538-91W/O CAP		SKRT1242-S hook with cap	KRT1242-S hook only	91-018348-91		SCP545
	91-140539-91W/O CAP		SKRT1242-R hook with cap	KRT1242-R hook only			
1244-720B	91-140538-91W/O CAP		SKRT1242-S hook with cap	KRT1242-S hook only			
1290C/D	91-018340-91W/CAP		SKRT545 with Cap	KRT545 hook only			
130			KR238-14				SC39-14
	91-064662-91W/O BC		KR238		91-009076-91		SC39
133, 134	91-009264-91W/O BC		KR134				



PFAFF (百福)

MACHINE (机器)	HOOK (梭梭)				BOBBIN CASE & CAP (梭壳 & 梭帽)			
	PART NO. (配件型号)	EX	KOBAN NO.1 (日文型号1)	KOBAN NO.2 (日文型号2)	PART NO. (配件型号)	EX	KOBAN NO. (日文型号)	
138			KR238-14				SC39-14	
	91-064662-91W/O BC		KR238		91-009076-91		SC39	
141 ~ 146	91-010165-91W/CAP		SKRT151S with Cap	KRT151S hook only	91-010159-91		SCPF15	
	91-010850-91W/CAP		SKRT145 with Cap	KRT145 hook only				
	91-010896-91W/CAP		SKRT191 with Cap	KRT191 hook only				
142-720, -721	91-010165-91W/CAP		SKRT151S with Cap	KRT151S hook only				
1470, 1490	91-119385-91W/CAP		SKRT490-S with Cap	KRT490-S hook only	91-119458-91		SCPF490	
151, 155	91-010165-91W/CAP		SKRT151S with Cap	KRT151S hook only	91-010159-91		SCPF15	
175-196	91-010850-91W/CAP		SKRT145 with Cap	KRT145 hook only				
	91-010896-91W/CAP		SKRT191 with Cap	KRT191 hook only				
190	91-015023-91W/CAP		SKRT190G with Cap	KRT190G hook only			SCPF19	
191 ~ 195 194-720	91-010165-91W/CAP		SKRT151S with Cap	KRT151S hook only	91-010159-91		SCPF15	
230	91-064662-91W/O BC		KR238		91-009076-91		SC39	
234	91-063090-91W/O BC		KR234					
238	91-064662-91W/O BC		KR238					
240A/B	91-010165-91W/CAP		SKRT151S with Cap	KRT151S hook only	91-010159-91		SCPF15	
260	91-064662-91W/O BC		KR238		91-009076-91		SC39	
290A/B	91-010165-91W/CAP		SKRT151S with Cap	KRT151S hook only	91-010159-91		SCPF15	
3114, 3115	91-008250-91W/O BC		KRP3114		91-008243-91		SC70-31	
3116	91-120710-91W/O BC		KRP3116					
3125A,B/3135A,B/ 3136A,B/3331A,B	91-006560-91		SH-P1					
3125C/3135C/ 3136C/3331C	91-006694-91		SH-P2					
3334 ~ 3337A, B	91-006560-91		SH-P1					
	91-006694-91		SH-P2					
335G	91-060581-91		KR335-V				SC335-V	
341-347	91-014192-91W/CAP		SKRT345 with Cap	KRT345 hook only	91-010159-91		SCPF15	
34-705-915/34-915- 944/34C, D/S/L	91-006694-91		SH-P2					
34-705A,B(S,L)/34- 900/34A, B/S/L	91-006560-91		SH-P1					
353-354	91-014192-91W/CAP		SKRT345 with Cap	KRT345 hook only	91-010159-91		SCPF15	
390			SKRT390 with Cap	KRT390 hook only			SCPF19	
434	91-061136-91W/O BC		KHS46		91-009076-91		SC39	
437 ~ 439	91-168883-91W/O BC		KHS438					
441 ~ 448 451 ~ 457	91-118876-91W/CAP		SKRT470-0-S with Cap	KRT470-0-S hook only	91-010159-91		SCPF15	
461~469, 461-900 ~469-900	91-171820-91W/O BC		KHS480		91-009076-91		SC39	

SABUN INDUSTRIAL CO.,LTD.

☆ = EXCLUSIVE ITEMS



PFAFF (百福)

MACHINE (机器)	HOOK (旋梭)				BOBBIN CASE & CAP (梭壳 & 梭帽)		
	PART NO. (配件型号)	EX	KOBAN NO.1 (日文型号1)	KOBAN NO.2 (日文型号2)	PART NO. (配件型号)	EX	KOBAN NO. (日文型号)
470	91-119385-91W/CAP		SKRT490-S with Cap	KRT490-S hook only	91-119458-91		SCPF490
	91-119386-91W/CAP		SKRT470-S with Cap	KRT470-S hook only	91-010159-91		SCPF15
	91-119899-91W/CAP		SKRT490-R with Cap	KRT490-R hook only	91-119458-91		SCPF490
471 ~ 493	91-119767-91W/CAP		SKRT470-R with Cap	KRT470-R hook only	91-010159-91		SCPF15
	91-119386-91W/CAP		SKRT470-S with Cap	KRT470-S hook only			
471-900 ~ 493-900	91-119899-91W/CAP		SKRT490-R with Cap	KRT490-R hook only	91-119458-91		SCPF490
	91-119385-91W/CAP		SKRT490-S with Cap	KRT490-S hook only			
481 ~ 489, 481-900 ~ 489-900	91-171820-91W/O BC		KHS480		91-009076-91		SC39
490	91-119385-91W/CAP		SKRT490-S with Cap	KRT490-S hook only	91-119458-91		SCPF490
	91-119386-91W/CAP		SKRT470-S with Cap	KRT470-S hook only	91-010159-91		SCPF15
	91-119899-91W/CAP		SKRT490-R with Cap	KRT490-R hook only	91-119458-91		SCPF490
490B/C	91-119767-91W/CAP		SKRT470-R with Cap	KRT470-R hook only	91-010159-91		SCPF15
541~546/544-720/ 551~555/591~596	91-018340-91W/CAP		SKRT545 with Cap	KRT545 hook only	91-018348-91		SCP545
	91-018482-91W/CAP		SKRT545S with Cap	KRT545S hook only			
871-893	91-010165-91W/CAP		SKRT151S with Cap	KRT151S hook only	91-010159-91		SCPF15
	91-010850-91W/CAP		SKRT145 with Cap	KRT145 hook only			
	91-010896-91W/CAP		SKRT191 with Cap	KRT191 hook only			
KSM-200	91-135660-91		KHS20-RPNG		99-135658-91		SC34-L

PROTEX (通字)

MACHINE (机器)	HOOK (旋梭)				BOBBIN CASE & CAP (梭壳 & 梭帽)		
	PART NO. (配件型号)	EX	KOBAN NO.1 (日文型号1)	KOBAN NO.2 (日文型号2)	PART NO. (配件型号)	EX	KOBAN NO. (日文型号)
GC39-1, 5550, 628			KHS12-S				SC31
GG20U			KR24U-42				SC35
TY-1130H			KHS12-GTH				SC31
TY-1130M TY2000			KHS12-S				
TY2000-5, -6 TY-6180H			KHS12-GTH				
TY-6180M TY-8500			KHS12-S				
TY-8211-413			KHS12-SP				
TY-8211-415			KHS12-GTHPD				SC31-NS
TY-8721-3			KHS12-SD				SC31
TY-8721-5			KHS12-RD				
TY-8842-3			KRT842F-S				

SABUN INDUSTRIAL CO., LTD.

☆ = EXCLUSIVE ITEMS

PROTEX (通宇)

MACHINE (机器)	HOOK (梭梭)				BOBBIN CASE & CAP (梭壳 & 梭帽)		
	PART NO. (配件型号)	EX	KOBAN NO.1 (日文型号1)	KOBAN NO.2 (日文型号2)	PART NO. (配件型号)	EX	KOBAN NO. (日文型号)
TY-8845-403			SKRT845KC with Cap	KRT842KC hook only			SCP-842BKC
TY-8875-5			SKRT875LK with Cap	KRT875LK hook only			SCP-LBK

RICHPEACE (宝盈)

MACHINE (机器)	HOOK (梭梭)				BOBBIN CASE & CAP (梭壳 & 梭帽)		
	PART NO. (配件型号)	EX	KOBAN NO.1 (日文型号1)	KOBAN NO.2 (日文型号2)	PART NO. (配件型号)	EX	KOBAN NO. (日文型号)
RPEB-CL, -FN			KHS12-RY				SC35-NS
			KHS12-RYP				
RPEB-MC			KHS12-RY				
RPEC-T RPED-CS			KHS12-RYP				
RPED-FH			KHS12-RYPOEJ				
RPED-FN RPED-MC RPED-TC RPMR			KHS12-RYP				
RPQ-E			KHS12-RYP				SC35-LNS
RPQ-ST			KHS20-RYP				

SANGOOD (双角)

MACHINE (机器)	HOOK (梭梭)				BOBBIN CASE & CAP (梭壳 & 梭帽)		
	PART NO. (配件型号)	EX	KOBAN NO.1 (日文型号1)	KOBAN NO.2 (日文型号2)	PART NO. (配件型号)	EX	KOBAN NO. (日文型号)
GC31			KHS12-S				SC31
GC32			KHS12-SPD2				SC31-NS
GC33, 34, 40-1, 45-1			KHS12-S				SC31
GF11001			KRP41-LH				SC70-2

SEIKO (精工)

MACHINE (机器)	HOOK (梭梭)				BOBBIN CASE & CAP (梭壳 & 梭帽)		
	PART NO. (配件型号)	EX	KOBAN NO.1 (日文型号1)	KOBAN NO.2 (日文型号2)	PART NO. (配件型号)	EX	KOBAN NO. (日文型号)
BEW-28BLCS, -28BLS, -8BLCS, -8BLS	61019		KRT467L				
CH-2B, -6B, -7B, -8B	28837C		KSP204				
CK-1	2530		KRT133				
CW-7B, -8B	13086		KRT31-11S				
H-2BL	18849		KHS20-RM3		18850		SC33-LNS
HC-2B	18982C		KR69-VP				SC39-NS
HC-2BL	17520		KHS20-GTVG		17522		SC33-LNS3S
HCL-2BL	19082		KHS20-R1E		18850		SC33-LNS
HCLH-2BL	17520		KHS20-GTVG		17522		SC33-LNS3S
JW-28BL-20	70140		KRT14-5-0				
JW-28BLC	95773		KRT14-5-0-C				
JW-8BL-20	70140		KRT14-5-0				
JW-8BLC	95773		KRT14-5-0-C				

SABUN INDUSTRIAL CO., LTD.

☆ = EXCLUSIVE ITEMS



SEIKO (精工)

MACHINE (機種)	HOOK (梭梭)				BOBBIN CASE & CAP (梭壳 & 梭帽)		
	PART NO. (配件型号)	EX	KOBAN NO.1 (在文型号1)	KOBAN NO.2 (在文型号2)	PART NO. (配件型号)	EX	KOBAN NO. (在文型号)
LCW-28BL LCW-8B, -8BL, -8BL-1	13719		KRT8-BL				
LHPW-28BL	14119		SKRT8-LPK-2 with Cap	KRT8-LPK hook only	158509C		SCP26-L
LHPW-8B-1	14175		SKRT470-RH with Cap	KRT470-RH hook only			SCPF15H
LHPW-8BL-1	14119		SKRT8-LPK-2 with Cap	KRT8-LPK hook only	158509C		SCP26-L
LLW-28, -28BL	15502		KRT-LSS				
LLW-28BL/CS	34110 (34104)		KRT8-LCS-CS				
LLW-28BLC/CS	34754		KRT8-LCI2-S				
LLW-28BL-TA			KRT-LSSB				
LLW-28L	15502		KRT-LSS				
LLW-28L-TA			KRT-LSSB				
LLW-8BL	15040		KRT-LSR				
LLW-8BL/CS	34075 (34041)		KRT8-LCP-CS				
LLW-8BLC/CS	34754		KRT8-LCI2-S				
LLW-8BL-TA	15232		KRT-LSRB				
LLW-8L	15040		KRT-LSR				
LLW-8L-TA	15232		KRT-LSRB				
LLWH-28BL/CS	34110 (34104)		KRT8-LCS-CS				
LLWH-28BL-TA	15232		KRT-LSRB				
LLWN-8BL/CS	34110 (34104)		KRT8-LCS-CS				
LPW-26, -26B LPW-27, -27B	12530		KRT31-SG				
LPW-27BL	14505		KRT8-LPS				
LPW-27BLC	36902		KRT26-LPC				
LPW-27BLK	14706		SKRT8-LPK with Cap	KRT8-LPK hook only	147059C		SCP-BLP
LPW-28, -28B	12530		KRT31-SG				
LPW-28BL	14505		KRT8-LPS				
LPW-28BLK	14706		SKRT8-LPK with Cap	KRT8-LPK hook only	147059C		SCP-BLP
LPW-28BLK-A			KRT8-LPS(B)				
LPW-28L	14505		KRT8-LPS				
LPW-6, -6B LPW-7, -7B LPW-8, -8B	12032		KRT31-RG				
LPW-8BL	14005		KRT8-LPR				
LPWN-28BL	14505		KRT8-LPS				
LPWN-28BLC	40854		KRT26-LPC2				
LPWN-8BL	14005		KRT8-LPR				
LPWN-8BLC	40854		KRT26-LPC2				
LSC-8B LSC-8BHC	17033		KR69-V		17034		SC39-14
LSC-8BL	17520		KHS20-GTVG		17318		SC39-14NS
LSC-8BV	17033		KR69-V		18550		SC33-LNS3S
LSW-26BL	15040		KRT-LSR		17034		SC39-14
LSW-26BL-G, -R	15850		SKRT26-L with Cap	KRT26-L hook only			SCP26-L
LSW-27BL	15502		KRT-LSS				
LSW-27BLK	16407		SKRT-BL with Cap	KRT-BL hook only			SCP-BL
LSW-27L LSW-28BL	15502		KRT-LSS				

SABUN INDUSTRIAL CO., LTD.

☆ = EXCLUSIVE ITEMS



SEIKO (精工)

MACHINE (机器)	HOOK (梭梭)				BOBBIN CASE & CAP (梭壳 & 梭帽)		
	PART NO. (配件型号)	EX	KOBAN NO.1 (日文型号1)	KOBAN NO.2 (日文型号2)	PART NO. (配件型号)	EX	KOBAN NO. (日文型号)
LSW-28BLK	16407		SKRT-BL with Cap	KRT-BL hook only			SCP-BL
LSW-28BL-TA	15232		KRT-LSRB				
LSW-28L	15502		KRT-LSS				
LSW-6L	15040		KRT-LSR				
LSW-6L-G	15850		SKRT26-L with Cap	KRT26-L hook only			SCP26-L
LSW-7BL, -7BL-T, -7L	15040		KRT-LSR				
LSW-7L-G	15850		SKRT26-L with Cap	KRT26-L hook only			SCP26-L
LSW-7L-T LSW-8BL	15040		KRT-LSR				
LSW-8BLC-CS-1	34754		KRT8-LC12-S				
LSW-8BLM	15040		KRT-LSR				
LSW-8BL-TA	15232		KRT-LSRB				
LSW-8BLV, -8BLVMF, -8BLVP, -8L, -8LM, -8L-T, -8LV, -8LVMF, -8LVP	15040		KRT-LSR				
LSWN-28L	34110 (34104)		KRT8-LCS-CS				
LSWN-28BL	34110 (34104)		KRT8-LCS-CS				
LSWN-8BL	34075 (34041)		KRT8-LCR-CS				
LSWN-8BL-A	34041A		KRT8-LCRB-CS				
LSWN-8BLV	34110 (34041)		KRT8-LCR-CS				
LTW-26, -27	11124		KRT12-5B				
LTW-27BK	16291		SKRT12-5BK with Cap	KRT12-5BK hook only			SCP-BK
LTW-27BLM	15502		KRT-LSS				
LTW-27BM	11124		KRT12-5B				
LW-27L	14505		KRT6-LPS				
LZ2-990-N2, 2N LZ2-770			KHS20-TZS				SC34-L
NCL-28L	18849		KHS20-RM3		18850		SC33-LNS
PW-26B-1 PW-27B PW-28B	12530		KRT31-SG				
PW-6, -6B-1 PW-7, -7B	12032		KRT31-RG				
PWB-22GW-1	37255		SKRT470-S with Cap	KRT470-S hook only	37255-7C		SCPF15
PWB-22GWC	37735		SKRT470C-S with Cap	KRT470C-S hook only	37735-7C		SCPF441
PWB-8GW-1	37256		SKRT470-R with Cap	KRT470-R hook only	37255-7C		SCPF15
PWB-8GWC, -FL, -LC	37735		SKRT470C-S with Cap	KRT470C-S hook only	37735-7C		SCPF441
PWB-8W	37255		SKRT470-S with Cap	KRT470-S hook only	37255-7C		SCPF15
SK-2B SK-6, -6F	1343C		KRT132				
SKM-26, -36	1526		KRT132-M				
SKZ-6	1855		KRT132-SKZ				
SLH-2B	35224		KSP7-31				

SABUN INDUSTRIAL CO., LTD.

☆ = EXCLUSIVE ITEMS



SEIKO (精工)

MACHINE (机器)	HOOK (旋梭)				BOBBIN CASE & CAP (梭壳 & 梭帽)		
	PART NO. (配件型号)	EX	KOBAN NO.1 (在文型号1)	KOBAN NO.2 (在文型号2)	PART NO. (配件型号)	EX	KOBAN NO. (在文型号)
SSH-8BLD SSH-8BLDC STH-8BL	18033	☆	KHS20-RPO		18099		SC33-LD
STW-26, -27, -28, .88M, .8M	10945		KRT11-5S				
STW-6, -7, -8, .88V, .8V	10655		KRT11-5				
TE-6, -6B TF-6, -6B	8028		KRT68				
TH-6B	28091C		KSP205				

SHANGGONG (上工)

MACHINE (机器)	HOOK (旋梭)				BOBBIN CASE & CAP (梭壳 & 梭帽)		
	PART NO. (配件型号)	EX	KOBAN NO.1 (在文型号1)	KOBAN NO.2 (在文型号2)	PART NO. (配件型号)	EX	KOBAN NO. (在文型号)
8900			KHS12-S				SC31
G15			KRP41-LH				SC70-2
GC0301 GC0601-1			KHS12-SD				SC82-JNS
GC1-3 GC15-1, .2			KHS12-S				SC31
GC15-3, -4 GC15-5-4D			KHS12-GTH KRT21				
GC22 GC30-1, .2, .3			KHS12-S				SC31
GC30-4-5D			KHS12-SPD2				SC31-NS
GC45-1			KHS12-S				SC31
GC505-1			KHS12-SD				SC82-JNS
GC5550			KHS12-S				SC31
GC555-4-5D			KHS12-SPD2				SC31-NS
GC8-2			KHS12-S				SC31
GD2302			SH280				SC980N
GD8-1, -4, -7			SKRT12-5LJKC-L with Cap	KRT12-5LJKC-L hook only			SCP-LJKC
			SKRT12-5LJKC-R1 with Cap	KRT12-5LJKC-R hook only			
GD9 GDB			KRT21				
GF108			KRP41-LH2				SC70-771

SICAMA (安機)

MACHINE (机器)	HOOK (旋梭)				BOBBIN CASE & CAP (梭壳 & 梭帽)		
	PART NO. (配件型号)	EX	KOBAN NO.1 (在文型号1)	KOBAN NO.2 (在文型号2)	PART NO. (配件型号)	EX	KOBAN NO. (在文型号)
BEISLER 842			SKRT842C with Cap	KRT842KC hook only			SCP-842BC
BEISLER 845			SKRT845KC with Cap	KRT842KC hook only			SCP-842BKC
LT2-8842			KRT12-5BF				
LT2-8842-3, -5			KRT12-5M				

SABUN INDUSTRIAL CO., LTD.

☆ = EXCLUSIVE ITEMS



SICAMA (安機)

MACHINE (機器)	HOOK (鉤梭)				BOBBIN CASE & CAP (梭壳 & 梭帽)		
	PART NO. (配件型号)	EX	KOBAN NO.1 (日文型号1)	KOBAN NO.2 (日文型号2)	PART NO. (配件型号)	EX	KOBAN NO. (日文型号)
LT2-8842-380, -580			KRT12-5BFCI				
LT2-8845			SKRT12-5BK with Cap	KRT12-5BK hook only			SCP-BK
LT2-8845-3, -5			SKRT12-5MK with Cap	KRT12-5MK hook only			SCP-MK
LT2-8845-380, -580			SKRT12-5BFKC with Cap	KRT12-5BFKC hook only			SCP-842BKC
LT2-8848-3			KRT12-5M				
LT2-8848-380 LT2-8849-380			KRT12-5BFCI				
LT2-8872, -3			KRT12-5LM				
LT2-8872-380			KRT12-5LMKCI				
LT2-8872-5			KRT12-5LM				
LT2-8872-580			SKRT875LKC with Cap	KRT875LC hook only			SCP-LBKC
LT2-8875, -3, -5			SKRT12-5LMK with Cap	KRT12-5LMK hook only			SCP-LMK
LT2-8875-380, -580			SKRT12-5LMKC-1 with Cap	KRT12-5LMKC hook only			SCP-LMKC
YAZICI 842			SKRT842C with Cap	KRT842KC hook only			SCP-842BC
YAZICI 845			SKRT845KC with Cap	KRT842KC hook only			SCP-842BKC

SINGER (勝家)

MACHINE (機器)	HOOK (鉤梭)				BOBBIN CASE & CAP (梭壳 & 梭帽)		
	PART NO. (配件型号)	EX	KOBAN NO.1 (日文型号1)	KOBAN NO.2 (日文型号2)	PART NO. (配件型号)	EX	KOBAN NO. (日文型号)
107G 107U202	224459 210533 210533		KRP41-S				
107W	210533HSB 224460		KRP41-R KRP41-L		224441		SC70-2
107W1/3/5/17	224459		KRP41-S				
107W100	224325		KRP21		224418		SC70-12
108U	224750		KRP108-R				
110K 110W124	237796 237796FG		KRT110-R KRT110				
110W124/128	237796 237796FG		KRT110-R KRT110				
110W-2	247675		SKRT19-R with Cap	KRT19-R hook only			SCP18
111W100/102/103/113	240207		KRT11-3				
111W150/151	240240		KRT11-50				
111W153/154	240207		KRT11-3				
111W155/156	240558		KRT11-5				
112W110	240091		KRT12-5R				
112W115-139	237204 240091		KRT12-5S KRT12-5R				
112W140/145/146	248463		KRT12-4				
118W	235797		SKRT18-S with Cap	KRT18-S hook only	241676		SCP18
1191D300A	414126		KHS12-SU1	KHS12-2S	52237		SC31



SINGER (勝家)

MACHINE (机種)	HOOK (送梭)				BOBBIN CASE & CAP (梭壳 & 梭帽)		
	PART NO. (配件型号)	EX	KOBAN NO.1 (日文型号1)	KOBAN NO.2 (日文型号2)	PART NO. (配件型号)	EX	KOBAN NO. (日文型号)
119W	247675		SKRT19-R with Cap	KRT19-R hook only	241676		SCP18
121C330AA 121D330AA	239727		KHS20-SPNP		530198		SC33-LNS
12W	207880		KSP17				
131W	236121		KRT31-R				
	238250		KRT31-11R				
	244521		KRT31-11S				
131W103/104/ 110/113		KRT31-R					
132K	103123		KRT132				
133K	103120		KRT133				
134W	264725		KRT134-L				
	264726		KRT134-R				
136W	249118		SKRT136 with Cap	KRT136 hook only	241676		SCP18
	264161		SKRT51 with Cap	KRT51 hook only			
	34799		SKRT51-S with Cap	KRT51-S hook only			
138G101, 103	34815		SKRT18-PS with Cap	KRT18-PS hook only	237168		SCP18-2
138G102 138W102	264161		SKRT51 with Cap	KRT51 hook only	241676		SCP18
143W1			KRP41-S		224441		SC70-2
144W, 145W	265093		KRT14-5				
	265093HP		KRT14-5HP				
153K 153W	238250		KRT31-11R				
1591D300G	544784		KHS12-SPUNS		52237NS		SC31-NS
167G/W	264414		SKRT18-P with Cap	KRT18-P hook only	237168		SCP18-2
167W	265720		KRT12-5R-18		241676		SCP18
168W	264414		KRT18-R		237168		SCP18-2
17U	547772		KRT68				
188U	546794		KR18		52237		SC31
18U	547772		KRT68				
191D	414126		KHS12-S		52237		SC31
20U13/23	541674		KR24-U		541678		SC35-T
	541968						
20U142	410054		KR24U-42				
20U31	410019		KR24U-31				
20U31/33/34	410140		KR24U-42S				
20U42 20U43 20UX143	410054		KR24U-42				
211A	554507		KRT12-5M				
211G146/151	244711		KRT211				
211G155/156	240558		KRT11-5				
211G157/157A/158 211G166 211G265/266	244711		KRT211				
211G351/357/358 211G465/466	514200		SKRT21-4L with Cap	KRT21-4L hook only	514241		SCP21-L
211G557/558/566A	510008		KRT211-L				

SABUKI INDUSTRIAL CO., LTD.

☆ = EXCLUSIVE ITEMS



SINGER (勝家)

MACHINE (机器)	HOOK (梭梭)				BOBBIN CASE & CAP (梭壳 & 梭帽)		
	PART NO. (配件型号)	EX	KOBAN NO.1 (日文型号1)	KOBAN NO.2 (日文型号2)	PART NO. (配件型号)	EX	KOBAN NO. (日文型号)
211G765/766	514200		SKRT21-4L with Cap	KRT21-4L hook only	514241		SCP21-L
211G866A/867A	510008		KRT211-L				
211GX102 211GX108	514200		SKRT21-4L with Cap	KRT21-4L hook only	514241		SCP21-L
211GX109	510008		KRT211-L				
211GX110	244711		KRT211				
211GX114	510008		KRT211-L				
211GX115	244711		KRT211				
211GX117	510008		KRT211-L				
211U157	244711		KRT211				
211U165/166	240558		KRT11-5				
211U257	244711		KRT211				
211U341/365	240558		KRT11-5				
211U566	510008		KRT211-L				
211U567	412307		KRT11-5LJR				
211U866	510008		KRT211-L				
211U867	412307		KRT11-5LJR				
211UX157	244711		KRT211				
211UX165/166	240558		KRT11-5				
211UX566	510008		KRT211-L				
211UX567	412307		KRT11-5LJR				
211W151/155	240588		KRT11-5				
211X104/106	510008		KRT211-L				
212A141BA, GA	554507		KRT12-5M				
212A143	281081		SKRT12-5MK with Cap	KRT12-5MK hook only			SCP-MK
212A147 212G140/141/ 145/440	267357		KRT21				
212G539/541	510008		KRT211-L				
212G641 212GX102/104	514200		SKRT21-4L with Cap	KRT21-4L hook only	514241		SCP21-L
212GX106	510008		KRT211-L				
212GX108/110	514200		SKRT21-4L with Cap	KRT21-4L hook only	514241		SCP21-L
212GX114	510008		KRT211-L				
212GX4/5/6	267357		KRT21				
212GX8	514200		SKRT21-4L with Cap	KRT21-4L hook only	514241		SCP21-L
212LX670 212U141	267357		KRT21				
212U143A/144	412433		SKRT21-K with Cap	KRT21-K hook only	412440		SCP-MK
212U41/442	267357		KRT21				
212U443A/444	412433		SKRT21-K with Cap	KRT21-K hook only	412440		SCP-MK
212U539A/839A	412307		KRT11-5LJR				
212U541A/841A	510008		KRT211-L				
212W140/145/ 146	267357		KRT21				



SINGER (勝家)

MACHINE (机器)	HOOK (梭梭)				BOBBIN CASE & CAP (梭壳 & 梭帽)		
	PART NO. (配件型号)	EX	KOBAN NO.1 (日文型号1)	KOBAN NO.2 (日文型号2)	PART NO. (配件型号)	EX	KOBAN NO. (日文型号)
21W162	203290		SKRT72 with Cap	KRT72 hook only	236853		SCP72
	203804		KRT51-11R				
	237796		KRT110-R				
	237796FG		KRT110				
21W180/182	238250		KRT31-11R				
21W30	203465		SKRT52 with Cap	KRT52 hook only	236853		SCP72
220U22, 23	414126		KHS12-SU1	KHS12-2S	52237		SC31
22W	203290		SKRT72 with Cap	KRT72 hook only	236853		SCP72
236G, W	263464		SKRT236 with Cap	KRT236 hook only	241676		SCP18
238G	241691		SKRT51-S with Cap	KRT51-S hook only			
271K	107122		KRP271		271785		SC70-27
281	143342FG		KHS12-S		52237		SC31
	143342LS		KHS12-SOHO				
	143342SN		KHS12-GS				
	143342TS		KHS12-GN				
	149172		KHS12-SAC				
	34825		KHS12-SND				
281-181/183/41291U	545990		KHS12-SU2				
31-15	12393		SH31				
331K	139654		SH33				
	143342FG		KHS12-S		52237		SC31
366	239780		KHS20-SPNP		239728		SC369
391U	545990		KHS12-SU2		52237		SC31
400W/402W/451K	143342FG		KHS12-S				
	143342LS		KHS12-SOHO				
	143342SN		KHS12-GS				
	143342TS		KHS12-GN				
	143342		KHS12-R				
412U	554507		KRT12-5M				
412U-141G	554824		KRT412-S				
431D200A	12393		SH31				
457A	417664		KRP457		502530		SC70-3
457G	34822		KRP457-W				
457U	417664		KRP457				
469U	418045		SH469-H				
469U	418505		SH469				
46W	238250		KRT31-11R				
47W70			KRT31-11S				
491D100GA/200GA 491D300GA/308GA	414126		KHS12-SU1	KHS12-2S	52237		SC31
491UX100/110B/G/H 491UX200/210B/G/H 491UX300/310B/G/H	544784		KHS12-SPU		52237NS		SC31-NS
51W	241691		SKRT51-S with Cap	KRT51-S hook only	241676		SCP18
52K 52W22	264161		SKRT51 with Cap	KRT51 hook only			
52W30/31	238250		KRT31-11R				

SABUN INDUSTRIAL CO., LTD.

☆ = EXCLUSIVE ITEMS



SINGER (勝家)

MACHINE (機種)	HOOK (旋梭)			BOBBIN CASE & CAP (梭壳 & 梭帽)																					
	PART NO. (配件型号)	EX	KOBAN NO.1 (在文型号1)	KOBAN NO.2 (在文型号2)	PART NO. (配件型号)	EX	KOBAN NO. (在文型号)																		
569U	418045		SH469-H																						
	418505		SH469																						
569U1141	418505-452		SH469-T																						
569U2108H	281776		SH180SH		281777		SC180S																		
569U2108M	282522		SH180SF																						
569U3141	418505-452		SH469-T																						
591C200AA 591C300AA 591D200AA 591D203/205 591D205AA 591D240AD/AF 591D30/302/303/3051 591D300AA 591D303AA 591D305AA 591D308AA 591DUX100 591E200A 591V200A 591V300A	414126		KHS12-SU1	KHS12-2S	52237		SC31																		
591C300GA 591D200 591D2108D/BF/GD/GF 591D210GA 591D215 591D240BF/GD/GF 591D300 591D300GA 591D3108D/BF 591D310GA/GD/GF 591D315 591D315GA 591D3188D/BF/GD/GF 591DX200GX 591DX210GA 591DX300GA 591DX310GA 591E200G 591E210G 591UX100 591UX220 591UX312 591UX313BF/GF 591UX313GAE 591UX320GF 591V200B 591V300B		544784						KHS12-SPUNS		52237NS		SC31-NS													
600W													143342FG		KHS12-S		52237		SC31						
691D100GD 691D110GD 691D150GD 691D200GD 691D210GD 691D250GD 691D300GD 691D310GD 691D350GD													544784		KHS12-SPUNS		52237NS		SC31-NS						
71														23503							SH51				
72W12														203290							SKRT72 with Cap	KRT72 hook only	236853		SCP72
7-31/33/56														58669							KSP7-31				
95-40/96-40														127119							KR21-R		52237		SC31
														127119							KR21-G				
														127119FG							KR21-S				

SABUN INDUSTRIAL CO., LTD.

☆ = EXCLUSIVE ITEMS



SIRUBA (高林)

MACHINE (机器)	HOOK (旋梭)				BOBBIN CASE & CAP (梭壳 & 梭帽)			
	PART NO. (配件型号)	EX	KOBAN NO.1 (日文型号1)	KOBAN NO.2 (日文型号2)	PART NO. (配件型号)	EX	KOBAN NO. (日文型号)	
DL889-L2-□ DL889-M1-□ DL889-M2-□	G121		KHS12-SPD2		G202		SC31-NS	
L818-F1 L818F-DM1/DM1A L818F-F1	G111		KHS12-2S		G201		SC31	
L818F-H1	G112		KHS12-R					
L818F-H1-□	G125		KHS12-RP		G202		SC31-NS	
L818F-H1A L818F-H1C	G112		KHS12-R		G201		SC31	
L818F-K1	G111		KHS12-2S					
L818F-K1/M1-□	G121		KHS12-SPD2		G202		SC31-NS	
L818F-L1	G111		KHS12-2S		G201		SC31	
L818F-L1-□	G121		KHS12-SPD2		G202		SC31-NS	
L818F-M1/HM1/ M1A/M1C	G111		KHS12-2S		G201		SC31	
L818F-NM1-□	G121		KHS12-SPD2		G202		SC31-NS	
L818F-RM1	G111		KHS12-2S		G201		SC31	
L818-H1	G112		KHS12-R					
L818-H1-□	G125		KHS12-RP		G202		SC31-NS	
L818-K1/M1	G111		KHS12-2S		G201		SC31	
L818-K1/M1-□	G121		KHS12-SPD2		G202		SC31-NS	
L818-L1	G111		KHS12-2S		G201		SC31	
L818-L1-□	G121		KHS12-SPD2		G202		SC31-NS	
L819-X1	G112		KHS12-R		G201		SC31	
L819-X1-U	G125		KHS12-RP		G202		SC31-NS	
L819-X2	G131		KHS20-RM2		G204		SC33-L	
L819-X2-U	G132		KHS20-RMPN		G205		SC33-LNS	
L918-H1	G112		KHS12-R		G201		SC31	
L918-H1-□	G125		KHS12-RP		G202		SC31-NS	
L918-H1A L918-H1C	G112		KHS12-R					
L918-HM1 L918-HM1A L918-L1	G111		KHS12-2S		G201		SC31	
L918-L1-□	G121		KHS12-SPD2		G202		SC31-NS	
L918-M1	G111		KHS12-2S		G201		SC31	
L918-M1-□	G121		KHS12-SPD2		G202		SC31-NS	
L918-M1A L918-M1C	G111		KHS12-2S		G201		SC31	
P717, P727	G151		KRT31-NR					
PK533 □ -L	G181		SH181		G207		SC181	
PK533M, H	G182		SH430-H		G208		SC430	
PK588A-M	G183		SH181H					
PK588-L	G181		SH181		G207		SC181	
PK588-M, H PK599-M, H	G183		SH181H					
R718-01	G152-A		SKRT470-R with Cap	KRT470-R hook only	G401		SCPF15	
R718-01-□	G155-A		SKRT470C-R with Cap	KRT470C-R hook only	G403		SCPF441	
R718-01H	G153-A		SKRT470-RHH with Cap	KRT470-RH hook only	G412		SCPF441H	
R718-02 R728-□□	G152-A		SKRT470-R with Cap	KRT470-R hook only	G401		SCPF15	



SIRUBA (高林)

MACHINE (机器)	HOOK (旋梭)				BOBBIN CASE & CAP (梭壳 & 梭帽)		
	PART NO. (配件型号)	EX	KOBAN NO.1 (日文型号1)	KOBAN NO.2 (日文型号2)	PART NO. (配件型号)	EX	KOBAN NO. (日文型号)
R728-□□-□	G155-A		SKRT470C-R with Cap	KRT470C-R hook only	G403		SCPF441
R728-□□H	G153-A		SKRT470-RHH with Cap	KRT470-RH hook only	G412		SCPF441H
T828-41-□□□□	G162-A		SKRT842FK-S with Cap	KRT842FK-S hook only	G406		SCP-842BC
T828-41-□□□HL	G167		KRT842H-S				
T828-41-□□□LL T828-41-□□□ML	G161		KRT842F-S				
T828-42-□□□□	G162-A		SKRT842FK-S with Cap	KRT842FK-S hook only	G406		SCP-842BC
T828-42-□□□□ □/□□	G164-A		SKRT842C with Cap	KRT842KC hook only			
T828-42-□□□HL	G167		KRT842H-S				
T828-42-□□□H/□□	G163		KRT842CI				
T828-42-□□□LL T828-42-□□□ML	G161		KRT842F-S				
T828-42-□□□M/□□	G163		KRT842CI				
T828-45-□□□H T828-45-□□□M T828-45-□□□X	G169-A		SKRT845BK with Cap	KRT845BK hook only	G409		SCP-842BK
T828-47-□□□□	G162-A		SKRT842FK-S with Cap	KRT842FK-S hook only	G406		SCP-842BC
T828-47-□□□□ □/□□	G164-A		SKRT842C with Cap	KRT842KC hook only			
T828-47-□□□LL T828-47-□□□W/□□	G161 G163		KRT842F-S KRT842CI				
T828-48-□□□L	G169-A		SKRT845BK with Cap	KRT845BK hook only	G409		SCP-842BK
T828-72-□□□H/ □□	G168-A		SKRT872LC with Cap	KRT875LC hook only	G411		SCP-LBC
T828-72-□□□HL	G165		KRT872L				
T828-72-□□□M/ □□	G168-A		SKRT872LC with Cap	KRT875LC hook only	G411		SCP-LBC
T828-72-□□□ML	G165		KRT872L				
T828-75-□□□H	G166-A		SKRT875LK with Cap	KRT875LK hook only	G407		SCP-LBK
T828-75-□□□H/ □□	G168-A1		SKRT875LKC with Cap	KRT875LC hook only	G408		SCP-LBKC
T828-75-□□□M	G166-A		SKRT875LK with Cap	KRT875LK hook only	G407		SCP-LBK
T828-75-□□□M/ □□	G168-A1		SKRT875LKC with Cap	KRT875LC hook only	G408		SCP-LBKC
T828-75-□□□X	G166-A		SKRT875LK with Cap	KRT875LK hook only	G407		SCP-LBK
T828-75-□□□X/ □□	G168-A1		SKRT875LKC with Cap	KRT875LC hook only	G408		SCP-LBKC
UC918-H1	G154		SKRT341G with Cap	KRT341G hook only	G402		SCP545
UF916-X2	G171		KRT12-5LMC				
UF916-X2-□	G173		KRT12-5LMKC-CI-NS				
UF918-X2 UF918-X2-□	G175		KRT467				
UF926-X2-□	G171		KRT12-5LMC				
UF926-X2-□-□	G173		KRT12-5LMKC-CI-NS				
UF926-X2L-□	G 172-A		SKRT12-5LMKC-C with Cap	KRT12-5LMKC-C hook only	G220		SCP-LMC

SABUN INDUSTRIAL CO., LTD.

☆ = EXCLUSIVE ITEMS

**SIRUBA (高林)**

MACHINE (机器)	HOOK (旋梭)				BOBBIN CASE & CAP (梭壳 & 梭帽)		
	PART NO. (配件型号)	EX	KOBAN NO.1 (日文型号1)	KOBAN NO.2 (日文型号2)	PART NO. (配件型号)	EX	KOBAN NO. (日文型号)
UF928-X2 UF928-X2-□	G175		KRT467				
YF616-X2	G 131		KHS20-RM2		G204		SC33-L
YF616-X2-□	G 132		KHS20-RMPN		G205		SC33-LNS
YF619-X2	G 131		KHS20-RM2		G204		SC33-L
YF619-X2-□	G 132		KHS20-RMPN		G205		SC33-LNS

STAGER (津久井)

MACHINE (机器)	HOOK (旋梭)				BOBBIN CASE & CAP (梭壳 & 梭帽)		
	PART NO. (配件型号)	EX	KOBAN NO.1 (日文型号1)	KOBAN NO.2 (日文型号2)	PART NO. (配件型号)	EX	KOBAN NO. (日文型号)
SE-12 SZ-21			KR24-T				SC35-T
SZ-21-1BN SZ-21-1BNL			KHS20-TZ				SC34-L
SZ-21-1N SZ-21-2N			KR24-T				SC35-T
SZ-21-3BNL			KHS20-TZ				SC34-L
SZ-21-3N			KR24-T				SC35-T
SZ-21-3NL SZ-21-4BNL			KHS20-TZ				SC34-L
SZ-21-4N			KR24-T				SC35-T
SZ-21-4NL SZ-21-5 SZ-21-5-3N SZ-21-5-3NL SZ-21-5-4N SZ-21-5-4NL SZ-21-5-5WN SZ-21-5N SZ-21-5NL			KHS20-TZ				SC34-L
SZ-21-6N SZ-21-7N SZ-21-8N SZ-25N			KR24-T				SC35-T
SZ-310-11N SZ-310-1N SZ-310-3N SZ-310-4N SZ-310-5-1N SZ-310-5-1WN SZ-310-5-3N SZ-310-5-4N			KRP457-W				SC70-3
SZ-72N SZ-72N-8N			KR24-T				SC35-T

SUNNUN (信能)

MACHINE (机器)	HOOK (旋梭)				BOBBIN CASE & CAP (梭壳 & 梭帽)		
	PART NO. (配件型号)	EX	KOBAN NO.1 (日文型号1)	KOBAN NO.2 (日文型号2)	PART NO. (配件型号)	EX	KOBAN NO. (日文型号)
DY-637			KHS20-R				SC33-L
EB-883			KR24				SC35
YU-740			KHS20-R				SC33-L



SUNSTAR (日星)

MACHINE (機器)	HOOK (梭梭)				BOBBIN CASE & CAP (梭壳 & 梭帽)		
	PART NO. (配件型号)	EX	KOBAN NO.1 (日文型号1)	KOBAN NO.2 (日文型号2)	PART NO. (配件型号)	EX	KOBAN NO. (日文型号)
BH/3000			KRP800				-
DPK-2			KRP41-S				SC70-2
KLZ-371			KR24				SC35
KM-1060BL			KRT467				
KM-123A			KHS12-S				SC31
KM-123B			KHS12-GTH				
KM-137A			KHS12-S				
KM-137B			KHS12-GTH				
KM-146BL			KHS20-GTB				SC33-L
KM-2070			KRP457TICC DLC coating (像鑽石一樣堅硬的石炭塗層)				
KM-18K			KRT68				
KM-235A			KHS12-SPD2				SC31-NS
KM-235B			KHS12-GTHPD				SC82-JNS
KM-250A KM-250A-7 KM-250AU KM-250AU-7 KM-250B KM-250B-7 KM-250BH-7			KHS12-SPA				SC31-NS
KM-340BL			KHS20-GTB				SC33-L
KM-350, -7			KHS12-SPA				SC31-NS
KM-350A			KHS12-SD				SC82-J
KM-350A-7			KHS12-SPD2				SC82-JNS
KM-350B			KHS12-GTH				SC31
KM-380, -380B			KR21-GTPDE				SC81-2
KM-380BL			KHS20-GTB				SC33-L
KM-390			KRT31-11SG				
KM-390BL			KRT8-BL				
KM-530, -7			KHS12-SD				SC82
KM-560			SKRT-BL with Cap	KRT-BL hook only			SCP-BL
KM-560-7			KRT-LS2CI-S				
KM-590BL			KHS20-HPEW				SC33-LD
KM-640BL			KHS20-RM2				SC33-L
KM-640BL-7			KHS20-RMP				SC33-LNS
KM-740			KRT12-58F				
KM-740BL			KRT12-5LM				
KM-750			KRT842F-S				
KM-750-7			KRT842CI				
KM-750-7BL			SKRT872LC with Cap	KRT875LC hook only			SCP-LBC
KM-750BL			KRT872L				
KM-790			SKRT845BK with Cap	KRT845BK hook only			SCP-842BK
KM-790-7			SKRT845KC with Cap	KRT842KC hook only			SCP-842BKC
KM-790BL			SKRT875LK with Cap	KRT875LK hook only			SCP-LBK
KM-790BL-7			SKRT875LKC with Cap	KRT875LC hook only			SCP-LBKC
KM-813 KM-817B KM-823 KM-827B			KRT31-S				

SABUN INDUSTRIAL CO., LTD.

☆ = EXCLUSIVE ITEMS



SUNSTAR (日星)

MACHINE (机器)	HOOK (梭梭)				BOBBIN CASE & CAP (梭壳 & 梭帽)		
	PART NO. (配件型号)	EX	KOBAN NO.1 (在文型号1)	KOBAN NO.2 (在文型号2)	PART NO. (配件型号)	EX	KOBAN NO. (在文型号)
KM-857, .7			SKRT470-R with Cap	KRT470-R hook only			SCPF15
KM-867			KRT31-NR				
KM-867-7 KM-875-7			SKRT470C-R with Cap	KRT470C-R hook only			SCPF441
KM-890			SKRT31-SKG with Cap	KRT31-SKG hook only			SCP31-K
KM-890-7			SKRT470CK-R with Cap	KRT470CK-R hook only			SCP470-CK
KM-957			SKRT470-R with Cap	KRT470-R hook only			SCPF15
SPS/C-5050			KHS20-RMP				SC33-LNS
SWF/A-T1201 SWF/A-UK1204-45 SWF/A-WE1218			KHS12-RY				SC35-NS

TAJIMA (田島)

MACHINE (机器)	HOOK (梭梭)				BOBBIN CASE & CAP (梭壳 & 梭帽)		
	PART NO. (配件型号)	EX	KOBAN NO.1 (在文型号1)	KOBAN NO.2 (在文型号2)	PART NO. (配件型号)	EX	KOBAN NO. (在文型号)
TEJT TFGN TFGN-C TFJT-C TFKN TFMX TFMX- II TFMX- II C TFMX-C TMCE TMLH							
	050210170016	☆	KHS12-RYPT2	KHS12-RYP			SC35-NS
	050210190015	☆	KHS12-RYPOET2				
	050230060012	☆	KHS12-RBPT2	KHS12-RBP			
	05022007J014	☆	KHS20-RYPT2	KHS20-RYP			SC35-LNS
	05022010J001	☆	KHS20-RYPNT2	KHS20-RYPN			
	05022005J015	☆	KHS20-RYPOET2				

TAKING (天王星)

MACHINE (机器)	HOOK (梭梭)				BOBBIN CASE & CAP (梭壳 & 梭帽)		
	PART NO. (配件型号)	EX	KOBAN NO.1 (在文型号1)	KOBAN NO.2 (在文型号2)	PART NO. (配件型号)	EX	KOBAN NO. (在文型号)
K-1800 K-1814 K-1818 K-1821 K-1828 K-1836 K-1842			SH280				SC980N
TK-1245 TK-1245L TK-1246 TK-1246L			SKRT1242-R hook with cap	KRT1242-R hook only			SCP545
TK-1247SHL TK-1247SHR TK-1248HB			SKRT391 hook with cap	KRT391 hook only			SCPF15H



TAKING (天王星)

MACHINE (机器)	HOOK (梭梭)				BOBBIN CASE & CAP (梭壳 & 梭帽)		
	PART NO. (配件型号)	EX	KOBAN NO.1 (日文型号1)	KOBAN NO.2 (日文型号2)	PART NO. (配件型号)	EX	KOBAN NO. (日文型号)
TK-1828H TK-1836H TK-1842H			SH282				SC980N
TK-243			KSP204N				
TK-335			KR24-B				SC34-1
TK-335LB			KHS20-R				SC33-L
TK-335N			KR24-B				SC34-1
TK-335NLB			KHS20-R				SC33-L
TK-341, -341N			SKRT341G with Cap	KRT341G hook only			SCP545
TK-441			KSP204N				
TK-457A, -457U			KRP457-W				SC70-3
TK-471			KSP204N				
TK-545, -546			SKRT545 with Cap	KRT545 hook only			SCP545
TK-551			SKRT545G with Cap	KRT545G hook only			
TK-591, -591B, -591BF			SKRT470-R with Cap	KRT470-R hook only			SCPF15
TK-591T, -591TB			SKRT470C-R with Cap	KRT470C-R hook only			SCPF441
TK-592, -592B, -592BF			SKRT470-R with Cap	KRT470-R hook only			SCPF15
TK-592T, -592TB			SKRT470C-R with Cap	KRT470C-R hook only			SCPF441
TK-652			KR24-B				SC34-1
TK-691, -691B, -691BF			SKRT470-R with Cap	KRT470-R hook only			SCPF15
TK-691T, -691TB			SKRT470C-R with Cap	KRT470C-R hook only			SCPF441
TK-692, -692B, -692BF			SKRT470-R with Cap	KRT470-R hook only			SCPF15
TK-692T, -692TB			SKRT470C-R with Cap	KRT470C-R hook only			SCPF441
TK-735, -735N			KR238				SC39
TK-810			KRT31-R				
TK-820			KRT31-NR				
TK-832			KRT12-5M				
TK-832-LB5			KRT12-5LM				
TK-842-3, -5			KRT12-5M				
TK-845-3, -5			SKRT12-5MK with Cap	KRT12-5MK hook only			SCP-MK
TK-86			KRT11-5LJS				
TK-872, -3, -5			KRT12-5LM				
TK-875-3, -5			SKRT12-5LMK with Cap	KRT12-5LMK hook only			SCP-LMK
TK-888, -888VB			KRP41-LH2				SC70-771
TK-89			KHS12-S				SC31
TK-89H			KHS12-R				
TK-88L			KHS20-RPEM2AO				SC33-LD
TK-991, -992			SKRT470-R with Cap	KRT470-R hook only			SCPF15



TANG (経緯)

MACHINE (机器)	HOOK (梭梭)				BOBBIN CASE & CAP (梭壳 & 梭帽)		
	PART NO. (配件型号)	EX	KOBAN NO.1 (日文型号1)	KOBAN NO.2 (日文型号2)	PART NO. (配件型号)	EX	KOBAN NO. (日文型号)
GC-1206-CT GG-1220A GG-1220C GG-906CT GG-920D GG-920F			KHS12-RYP				SC35-NS

TOYOTA (豊田)

MACHINE (机器)	HOOK (梭梭)				BOBBIN CASE & CAP (梭壳 & 梭帽)		
	PART NO. (配件型号)	EX	KOBAN NO.1 (日文型号1)	KOBAN NO.2 (日文型号2)	PART NO. (配件型号)	EX	KOBAN NO. (日文型号)
AD1000 AD1012G AD1202K AD1203V	2111704310C		KHS12-SPA3		2110604-301B		SC31-NS
AD140B AD146G	2110904310		KHS12-GTH		2110104-301C		SC31
AD148	2120604310		KHS12-S				
AD148B	2110904310		KHS12-GTH				
AD148M	2120604310		KHS12-S				
AD150G	2110904310		KHS12-GTH				
AD156	2120604310		KHS12-S				
AD156G	2110904310		KHS12-GTH				
AD156M	2120604310		KHS12-S				
AD157	2111704310C		KHS12-SPA3		2110604-301B		SC31-NS
AD157G-500	2110904310		KHS12-GTH		2110104-301C		SC31
AD2000, AD3000	2111704310C		KHS12-SPA3		2110604-301B		SC31-NS
AD320-22	2122304310G		KHS20SPEM2ANG		2122304301B		SC33-LD
AD331L, LP AD332L, LP	2121414310		KRT-LS2S				
AD338	2120604310		KHS12-S		2110104-301C		SC31
AD340	2121414310C		KHS12-SPD3		2121604-301B		SC82-JNS
AD340-22, -622	2111704310C		KHS12-SPA3		2110604-301B		SC31-NS
AD340B	2121624310B		KHS12-RHPD		2121604-301B		SC82-JNS
AD340B-22			KHS12-GTHPD		2110604-301B		SC31-NS
AD340B-622 AD341	2121414310C		KHS12-SPD3		2121604-301B		SC82-JNS
AD345	2120604310		KHS12-S		2110104-301C		SC31
AD345-22, -622	2111704310C		KHS12-SPA3		2110604-301B		SC31-NS
AD352	2120604310		KHS12-S		2110104-301C		SC31
AD352-702	2111704310C		KHS12-SPA3		2110604-301B		SC31-NS
AD550, 551, 552, 553	2130504310		KRP457		2130704-301A		SC70-3
AD740, 740B	2140114310		KRT21				
AD830	2161914310		KHS12-RYP				SC35-NS
AD851	2161924310		KHS12-RYPAICC				
D324	2120304-310B		KHS20-S		2120304-301		SC33-L
D530, 530E, 532, 533, 534	2130104-300		KHS20-ST		2130104-301A		SC34-L



TREASURE (珠寶)

MACHINE (機器)	HOOK (旋梭)				BOBBIN CASE & CAP (梭壳 & 梭帽)		
	PART NO. (配件型号)	EX	KOBAN NO.1 (日文型号 1)	KOBAN NO.2 (日文型号 2)	PART NO. (配件型号)	EX	KOBAN NO. (日文型号)
HS-5500	S60197A		SKRT19-R with Cap	KRT19-R hook only			SCP18

TYPICAL (標準)

MACHINE (機器)	HOOK (旋梭)				BOBBIN CASE & CAP (梭壳 & 梭帽)		
	PART NO. (配件型号)	EX	KOBAN NO.1 (日文型号 1)	KOBAN NO.2 (日文型号 2)	PART NO. (配件型号)	EX	KOBAN NO. (日文型号)
GC20201			KRT12-5M				
GC20201-1			KRT12-5MR				
GC20202			KRT12-5LM				
GC20202-1			KRT12-5LMR				
GC24080			KRT31-NR				
GC38-1, -2 GC40-1, -2, -4 GC6-1			KHS12-S				SC31
GC6-10/11			KHS12-SD				SC82-J
GC6100HD			KHS12-SB30HO				SC31
GC6160			KHS12-SD				SC82-J
GC6160H			KHS12-SPB30HO				SC31
GC6-1-D3			KHS12-SP				SC31-NS
GC6150M/H			KHS12-R				
GC6220B			KRT12-5LM				
GC6220BD			KRT12-5LMKCI				
GC6220M			KRT12-5M				
GC6220MD			KRT12-5MCI				
GC6240B			SKRT12-5LMK with Cap	KRT12-5LMK hook only			SCP-LMK
GC6240M			SKRT12-5MK with Cap	KRT12-5MK hook only			SCP-MK
GC6240MD			SKRT12-5MC-2 with Cap	KRT12-5MC hook only			SCP-MKC
GC6240MD2			SKRT12-5MC-1 with Cap	KRT12-5MC hook only			SCP-MC
GC6-28			KHS12-S				SC31
GC6-5, -6, -7			KHS20-RMP				SC33-LNS
GC6-8			KHS12-R				SC31
GC6710M/HD3			KHS12-SPM				SC31-NS
GC6730MD3			KHS12-SPD2				
GC6730HD3			KHS12-SPB30HO				SC31
GC6842H			KRT842H-S				
GC6842HD3			SKRT842C with Cap	KRT842KC hook only			SCP-842BC
GC6842M			KRT842F-S				
GC6842MD3			SKRT842C with Cap	KRT842KC hook only			SCP-842BC
GC6845, H			SKRT845BK with Cap	KRT845BK hook only			SCP-842BK
GC6845HD3			SKRT845KC with Cap	KRT842KC hook only			SCP-842BKC
GC6872, H, M			KRT872L				
GC6872MD3			SKRT872LC with Cap	KRT875LC hook only			SCP-LBC



TYPICAL (標準)

MACHINE (機器)	HOOK (鉤梭)				BOBBIN CASE & CAP (梭壳 & 梭帽)		
	PART NO. (配件型号)	EX	KOBAN NO.1 (日文型号1)	KOBAN NO.2 (日文型号2)	PART NO. (配件型号)	EX	KOBAN NO. (日文型号)
GC6875H			SKRT875LK with Cap	KRT875LK hook only			SCP-LBK
GC6875HD3			SKRT875LKC with Cap	KRT875LC hook only			SCP-LBKC
GC6875M			SKRT875LK with Cap	KRT875LK hook only			SCP-LBK
GC6875MD3			SKRT875LKC with Cap	KRT875LC hook only			SCP-LBKC
GC6-8A, -8B			KHS12-GTH				SC31
GC6-8-D2			KHS12-GTHPD				SC31-NS
GC6-9			KHS20-RM2				SC33-L
GC69-1			KHS12-S				SC31
GC6-9-D2			KHS20-RMP				SC33-LB
GC9420M			KRT842F-S				
GC9420M/HD3			SKRT842C with Cap	KRT842KC hook only			SCP-8428C
GC9420H			KRT842H-S				
GC9450			SKRT845BK with Cap	KRT845BK hook only			SCP-8428K
GC9450M/HD3			SKRT845KC with Cap	KRT842KC hook only			SCP-8428KC
GC9720			KRT872L				
GC9720M/HD3			SKRT872LC with Cap	KRT875LC hook only			SCP-LBC
GC9750			SKRT875LK with Cap	KRT875LK hook only			SCP-LBK
GC9750M/HD3			SKRT875LKC with Cap	KRT875LC hook only			SCP-LBKC
GG1-1, -2			KR24				SC35
GN2301, 2603			KHS20-RMP				SC33-LNS
GYD12-6, 20-6, 7-6			KHS12-RY				SC35-NS

TYPICAL WANPING (莞埤)

MACHINE (機器)	HOOK (鉤梭)				BOBBIN CASE & CAP (梭壳 & 梭帽)		
	PART NO. (配件型号)	EX	KOBAN NO.1 (日文型号1)	KOBAN NO.2 (日文型号2)	PART NO. (配件型号)	EX	KOBAN NO. (日文型号)
1245			SKRT1242-R hook with cap	KRT1242-R hook only			SCP545
733R			KSP7-31				
842			KRT12-5BFCI				
845			SKRT845KC with Cap	KRT842KC hook only			SCP-8428KC
872			SKRT872LC with Cap	KRT875LC hook only			SCP-LBC
875			SKRT875LKC with Cap	KRT875LC hook only			SCP-LBKC
B727 GC0302			KHS20-GTB				SC33-L
GC0302-D2			KHS20-SMP				SC33-LNS
GC203			KHS12-R				SC31
			KHS12-S				
GC20606			KRT12-5LM				

SABUN INDUSTRIAL CO., LTD.

☆ = EXCLUSIVE ITEMS



TYPICAL WANPING (莞坪)

MACHINE (机器)	HOOK (旋梭)				BOBBIN CASE & CAP (梭壳 & 梭帽)		
	PART NO. (配件型号)	EX	KOBAN NO.1 (佐文型号1)	KOBAN NO.2 (佐文型号2)	PART NO. (配件型号)	EX	KOBAN NO. (佐文型号)
GC24016			KRT31-NR				
GC24026			KRT31-SG				
GC24080			KRT31-NR				
GC24660, 24680			SKRT470-S with Cap	KRT470-S hook only			SCPF15
GC3002CX			KHS20-RPE				SC33-LD
GC6-5, -6, -7 GN2301, 2603			KHS20-RMP				SC33-LNS
PWB-8GW			SKRT470-R with Cap	KRT470-R hook only			SCPF15
SK-2B			KRT132				
TW1-0602			KHS20-RPEM2AO				SC33-LD
TW1-1245			SKRT1242-R hook with cap	KRT1242-R hook only			SCP545
TW2-8842, -3			KRT842F-S				
TW2-8842-905			KRT842CI				
TW2-8845, -5			SKRT845BK with Cap	KRT845BK hook only			SCP-842BK
TW2-8845-905			SKRT845KC with Cap	KRT842KC hook only			SCP-842BKC
TW2-8872			KRT872L				
TW2-8872-905			SKRT872LC with Cap	KRT875LC hook only			SCP-LBC
TW2-8875			SKRT875LK with Cap	KRT875LK hook only			SCP-LBK
TW2-8875-905			SKRT875LKC with Cap	KRT875LC hook only			SCP-LBKC
TW3-234			KSP204N				
TW3-335, 335V			KR69-V				SC39-14
TW3-341			SKRT341-NR with Cap	KRT341-NR hook only			SCP545
TW3-441, -471			KSP204N				
TW3-8B			KRT31-11S				
TW3-P335			KR23B				SC39-14
TW3-S336VB			KHS20-GTVG				SC33-LNS3
TW5-810			KRT31-NR				
TW5-820			KRT31-SG				
TWB-22GW			SKRT470-R with Cap	KRT470-R hook only			SCPF15

UNICORN (神馬)

MACHINE (机器)	HOOK (旋梭)				BOBBIN CASE & CAP (梭壳 & 梭帽)		
	PART NO. (配件型号)	EX	KOBAN NO.1 (佐文型号1)	KOBAN NO.2 (佐文型号2)	PART NO. (配件型号)	EX	KOBAN NO. (佐文型号)
DB2-H310, H510, H515			KHS12-S				SC31
DB2-H311, H510H, H515H			KHS12-R				
DB2-H312, H510XH, H515XH			KHS20-RM2				SC33-L
DB2-H320/321			KRT12-5M				
DB2-H322/323			KRT12-5LM				



UNICORN (神馬)

MACHINE (機器)	HOOK (旋梭)				BOBBIN CASE & CAP (梭壳 & 梭帽)		
	PART NO. (配件型号)	EX	KOBAN NO.1 (日文型号1)	KOBAN NO.2 (日文型号2)	PART NO. (配件型号)	EX	KOBAN NO. (日文型号)
LS2-H5100H, 5150H			KHS12-GTHPD				
LS2-H5100(M), H5150M			KHS12-SPD2				SC31-NS
LS2-H5150XH, H5110XH			KHS20-RMP				SC33-LNS
LS2-H5200, H5300			KHS12-SPD2				SC31-NS
LS2-H520			KHS12-SD				SC31
LS2-H530			KHS12-SB2				
LS2-H540, H5400, H5100XH			KHS20-RMP				SC33-LNS
LS2-H620(H)			KRT12-5LM				
LS2-H620(M)			KRT12-5M				
LT2-H6200(H)			KRT12-5LMKCI				
LT2-H6200(M)			KRT12-5MCI				
LT2-H6250(M)			SKRT12-5MC-1 with Cap	KRT12-5MC hook only			SCP-MC
LT2-H625(H)			SKRT12-5LMK with Cap	KRT12-5LMK hook only			SCP-LMK
LT2-H625(M)			SKRT12-5MK with Cap	KRT12-5MK hook only			SCP-MK
LT5-H710, H720			KRT31-SG				
LT5-H7200, H7600			SKRT470C-R with Cap	KRT470C-R hook only			SCPF441
LZ2-H272			KR24				SC35
PLN-7B/27B			KRT31-SG				
TZ1-8652			KR24-B				SC35

UNION SPECIAL (於仁)

MACHINE (機器)	HOOK (旋梭)				BOBBIN CASE & CAP (梭壳 & 梭帽)		
	PART NO. (配件型号)	EX	KOBAN NO.1 (日文型号1)	KOBAN NO.2 (日文型号2)	PART NO. (配件型号)	EX	KOBAN NO. (日文型号)
61200	61207D		KR62				SC31
61200/61400/ 61900	61407B		KHS14-G		61413		SC83
	61407BFG		KHS14-S				
	61407BSN		KHS14-SS		63913A		SC639
	61407BTS		KHS14-GN				
61800/62200	29474AC		KRT22				
63400/63900	61407B		KHS14-G		61413		SC83
	61407BFG		KHS14-S				
	61407BSN		KHS14-SS		63913A		SC639
	61407BTS		KHS14-GN				

YAKUMO (八云)

MACHINE (機器)	HOOK (旋梭)				BOBBIN CASE & CAP (梭壳 & 梭帽)		
	PART NO. (配件型号)	EX	KOBAN NO.1 (日文型号1)	KOBAN NO.2 (日文型号2)	PART NO. (配件型号)	EX	KOBAN NO. (日文型号)
171L	B1830141HA0		KHS20-RM3		201144000		SC33-L
178Y-2	112034010		KHS12-SP		112035000		SC31-NS
178Y-3	112034020		KHS12-RPN				

SABUN INDUSTRIAL CO., LTD.

☆ = EXCLUSIVE ITEMS



YAKUMO (八云)

MACHINE (机器)	HOOK (旋梭)				BOBBIN CASE & CAP (梭壳 & 梭帽)		
	PART NO. (配件型号)	EX	KOBAN NO.1 (在文型号1)	KOBAN NO.2 (在文型号2)	PART NO. (配件型号)	EX	KOBAN NO. (在文型号)
180LY-2, 181LY	D1830141EA0		KHS20-RMPN		D1837141EA0		SC33-LNS3
241L	117074005		KRT11-5LJR				
242L	B1830521HA0		KRT11-5LJKR		B18375210A0		SCP-LJ
					B18375260A0		SCP-LJK
243	21041850		KSP204N				
280L	110017000		KHS20-HPEW		B1837241H00		SC33-LD
280LY	D1830141EA0		KHS20-RMPN				
281LY, 281LY-B	D1830241EA0		KHS20-RMPNW		D1837141EA0		SC33-LNS3
321L	21228051		SKRT341G with Cap	KRT341G hook only	115470005		SCP545
340	B18013400A0		KRT31-11SG				
341	B18303110A0		KRT341G				
341L	21228051		SKRT341G with Cap	KRT341G hook only	115470005		SCP545
380, 380B, 380Y	109068010		KR21-RPDE		109471005		SC81-2NS2
	109068030		KR21-GTPDE				
381L	110017000		KHS20-HPEW		B1837241H00		SC33-LD
381LY	D1837141EA0		KHS20-RMPN		D1837141EA0		SC33-LNS3
411 ~ 471	21041850		KSP204N				
480L	111066110		KRT12-5LJR				
481L, 482L	222098000		KRT11-5LJR				
561 ~ 564	116728000		SKRT470-S with Cap	KRT470-S hook only			SCPF15
580L	B1830141HA0		KHS20-RM3		201144000		SC33-L
680LY	D1830141EA0		KHS20-RMPN		D1837141EA0		SC33-LNS3
681	21209051		KHS12-RPN2D2		109471005		SC81-2NS2
	21209952		KHS12-GTPN2D2				
681LY-B	D1830141EA0		KHS20-RMPN		D1837141EA0		SC33-LNS3
880LM	110017000		KHS20-HPEW		B1837241H00		SC33-LD
981 ~ 986	21010251		KRT31-NR				
DBE-780, -N63 DBU-175	103109020		KR21-S		203072000		SC31
DBU-175L	B1830141HA0		KHS20-RM3		201144000		SC33-L
DBU-180	103109020		KR21-S		203072000		SC31
DBU-180-2	103109010		KR21-R				
DBU-180L-2	B1830141HA0		KHS20-RM3		201144000		SC33-L
DBU-181LY DBU-681LY	D1830141EA0		KHS20-RMPN		D1837141EA0		SC33-LNS3
DEU-750, -780, -N70	103109020		KR21-S		203072000		SC31
DNU-241H	D1830241EA0		KHS20-RMPNW		D1837141EA0		SC33-LNS3
DSC-245	B18302450A0		KHS12-GTPND2		B18372450A0		SC82-JNS2
DSC-246	110017000		KHS20-HPEW		B1837241H00		SC33-LD
DSN-165, -170, -178	104114020		KHS12-S		203072000		SC31
DSN-178-3	104114010		KHS12-R				
DSN-178L-2	104507000		KHS20-S		D1837141EA0		SC33-LNS3
DSN-178L-3	B1830141HA0		KHS20-RM3		201144000		SC33-L
DSN-78, -80-2	103109020		KR21-S		203072000		SC31
DSN-80-3	103109010		KR21-R				
DSN-80L DU-141H	B1830141HA0		KHS20-RM3		D1837141EA0		SC33-LNS3
DU-141H-5, -6, -7	D1830141EA0		KHS20-RMPN				
PLN-985	21010251		KRT31-NR				



YAMATO (大和)

MACHINE (机器)	HOOK (旋梭)				BOBBIN CASE & CAP (梭壳 & 梭帽)		
	PART NO. (配件型号)	EX	KOBAN NO.1 (日文型号1)	KOBAN NO.2 (日文型号2)	PART NO. (配件型号)	EX	KOBAN NO. (日文型号)
DP-2, -3			KRP41-S				SC70-2
LG-2000, -2125 LW			KRP457-W3				SC70-3NS

YULUN (友倫)

MACHINE (机器)	HOOK (旋梭)				BOBBIN CASE & CAP (梭壳 & 梭帽)		
	PART NO. (配件型号)	EX	KOBAN NO.1 (日文型号1)	KOBAN NO.2 (日文型号2)	PART NO. (配件型号)	EX	KOBAN NO. (日文型号)
457A-105L, -125L, -135L, -140L			KRP457-W				SC70-3
475A-143NL			KRP457TICC DLC coating (像鑽石一樣堅硬的石炭塗層)				SC70-3T
457A-505-PBG-NHL 457A-525-PBG-NHL			KRP457				SC70-3
457A-535-PBG-NHL 457A-543-PBG-NHL			KRP457TICC DLC coating (像鑽石一樣堅硬的石炭塗層)				SC70-3T
457A-605-NCB-LG 457A-625-NCB-LG			KRP457				SC70-3
457A-635-NCB-LG 457A-643-NCB-LG			KRP457TICC DLC coating (像鑽石一樣堅硬的石炭塗層)				SC70-3T
YLM-1245, -1246			SKRT1242-R hook with cap	KRT1242-R hook only			SCP545
YLM-335			KR24-B				SC35
YLM-340, -350-22			KHS20-R				SC33-L
YLM-457A			KRP457-W				SC70-3
YLM-545, -546			SKRT1242-R hook with cap	KRT1242-R hook only			SCP545
YLM-572W, -671W			SKRT470-R with Cap	KRT470-R hook only			SCPF15
YLM-810-G, -820-G			KRT31-R				

YXSM (裕祥)

MACHINE (机器)	HOOK (旋梭)				BOBBIN CASE & CAP (梭壳 & 梭帽)		
	PART NO. (配件型号)	EX	KOBAN NO.1 (日文型号1)	KOBAN NO.2 (日文型号2)	PART NO. (配件型号)	EX	KOBAN NO. (日文型号)
YU-1850-M, -1850-XL			SH280				SC980N

ZGM (珠光)

MACHINE (机器)	HOOK (旋梭)				BOBBIN CASE & CAP (梭壳 & 梭帽)		
	PART NO. (配件型号)	EX	KOBAN NO.1 (日文型号1)	KOBAN NO.2 (日文型号2)	PART NO. (配件型号)	EX	KOBAN NO. (日文型号)
GG798-1			KHS12-RYP				SC35-NS
GG798-3			KHS12-R				



ZOJE (中捷)

MACHINE (机器)	HOOK (钩梭)				BOBBIN CASE & CAP (梭壳 & 梭帽)		
	PART NO. (配件型号)	EX	KOBAN NO.1 (日文型号1)	KOBAN NO.2 (日文型号2)	PART NO. (配件型号)	EX	KOBAN NO. (日文型号)
1163			KHS12-S				SC31
1163-5			KHS12-R				
842-5			KRT842H-S				
842-D3			KRT12-5BFCI				
845			SKRT845BK with Cap	KRT845BK hook only			SCP-842BK
845-D3			SKRT845KC with Cap	KRT842KC hook only			SCP-842BKC
872			KRT872L				
872-D3			SKRT872LC with Cap	KRT875LC hook only			SCP-LBC
875			SKRT875LK with Cap	KRT875LK hook only			SCP-LBK
875-D3			SKRT875LKC with Cap	KRT875LC hook only			SCP-LBKC
GC15-1, 5580			KHS12-2S				SC31
GC5580-5			KHS12-R				
GC80-1			KHS12-2S				
GC80-5			KHS12-GTH				
GC90-1			KHS12-2S				
GC90-5			KHS12-GTH				
GC2201-1			KHS12-2S				
GG20U142, 143, 23, 33, 42, 53, 63			KR24U-42				SC35
GG457			KRP457				SC70-3
ZJ15-1			KHS12-2S				SC31
ZJ1900			SH280				SC980N
ZJ1900HS			SH282				
ZJ1903, -303, -304, -305			SH280				
ZJ201-1			KHS12-S				SC31
ZJ20U23, 33, 43, 53, 63			KR24U-42				SC35
ZJ2628			KHS12-GTPND2				SC82-JNS
ZJ457A/B/D ZJ457A125/105, 135, 143			KRP457				SC70-3
ZJ5550, 5580			KHS12-2S				SC31
ZJ5580-5			KHS12-GTH	KHS12-R			
ZJ5580-5-D3 ZJ5580-D3			KHS12-SPD2				SC31-NS
ZJ5600N			KHS12-GTH				SC31
ZJ80-1			KHS12-2S				
ZJ842			KRT842F-S				
ZJ842-5			KRT842H-S				
ZJ845, -5			SKRT845BK with Cap	KRT845BK hook only			SCP-842BK
ZJ8500-5			KHS12-GTH	KHS12-R			SC31
ZJ8500-D3			KHS12-SPD2				SC31-NS
ZJ8500H			KHS20-RM2				SC33-L
ZJ8500N			KHS12-2S				SC31
ZJ8600			KHS12-S				
ZJ872, -5			KRT872L				
ZJ875, -5			SKRT875LK with Cap	KRT875LK hook only			SCP-LBK

SABUN INDUSTRIAL CO., LTD.

☆ = EXCLUSIVE ITEMS

**ZOJE (中捷)**

MACHINE (机器)	HOOK (钩梭)				BOBBIN CASE & CAP (梭壳 & 梭帽)		
	PART NO. (配件型号)	EX	KOBAN NO.1 (日文型号1)	KOBAN NO.2 (日文型号2)	PART NO. (配件型号)	EX	KOBAN NO. (日文型号)
ZJ8300			KHS12-S				SC31
ZJ8300-5			KHS12-R				
ZJ8350-S-D3			KHS12-SPD2				SC31-NS
ZJ90-1, 999			KHS12-2S				SC31

ZSK

MACHINE (机器)	HOOK (钩梭)				BOBBIN CASE & CAP (梭壳 & 梭帽)		
	PART NO. (配件型号)	EX	KOBAN NO.1 (日文型号1)	KOBAN NO.2 (日文型号2)	PART NO. (配件型号)	EX	KOBAN NO. (日文型号)
J Series L Series M Series T Series X Series	573203 573036		KR134Z		570583		SC39-ZSKNS
			KR134ZICC KR134ZVICC		570649		SC39-34NS



6. VARIETIES OF HOOK GIBS (旋梭压板的种类)

Koban Hook has three types of gibs suitable for various kinds of materials, being R, S, and G as mentioned below.

(佐文牌梭 'R' 'S' 'G' 三种旋梭压板的各种料缝切条件)

R=Short gib for heavy materials. (短旋梭压板型, 厚料用)

S=Long gib for light materials. (长旋梭压板型, 薄料用)

G=Tacking gib for general materials. (中间旋梭压板型, 一般厚料用)

We indicate the above letters in our Article No. (上記说明文字中使用了我司的制品名称)

For instance : KHS12-R, KHS12-S, KHS12-G, KRT12-5R, KRT31-S

(例如 KHS12-R, KHS12-S, KHS12-G, KRT12-5R, KRT31-S)

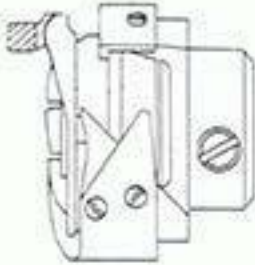
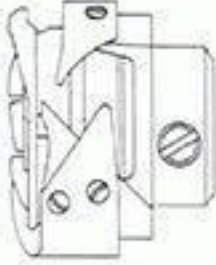
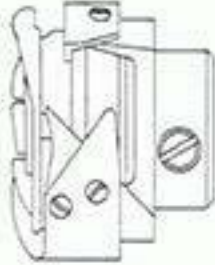
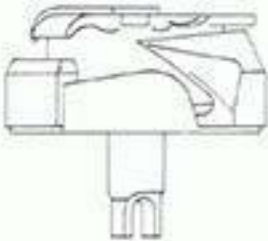
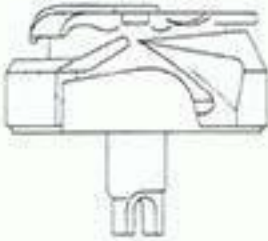
R type	S type	G type
		
		



7. WONDER HOOK

PATENTED
(取得特許)

**LEADING MODELS (例如如下商品)**

KHS12-RYNW		FOR EMBROIDERY MACHINE, WITH TEFLON BASE (刺绣机用 内梭特氟隆加工)
KHS12-RYPBNW	BARUDAN	BENR, BENS, BENT, WITH TEFLON BASE (内梭特氟隆加工)
KHS12-RYPBW	BARUDAN	BENR, BENS, BENT
KHS12-RYPNW	BARUDAN	BENR, BENS, BENT, WITH TEFLON BASE (内梭特氟隆加工)
KHS12-RYPW		FOR EMBROIDERY MACHINE (刺绣机用)
KHS12-SPNJW		FOR THREAD TRIMMER WITH SHARP POINT (自动切线机用 梭尖锋利)
KHS12-SPW		FOR THREAD TRIMMER (自动切线机用)
KHS20-HPEW	JUKI	DNU-241-H

* Reducing the tension of upper thread.
(上线张力可以下调)

* Constant stitch at any sewing speed.
(无论怎样的缝纫速度都可以稳定的缝制)

* Just fit to any threads and any materials.
(各种布料, 线都适用)



8. DLC (Diamond Like Carbon) Coating (像钻石一样坚硬的石炭)

PATENT PENDING
(特許申請中)



LEADING MODELS (例如如下商品)

KHS12-SPD8CC	HIGH SPEED AUTO TRIMMER with DLC Body and Base (高速平缝自动切线机用外梭内梭 DLC 加工)
KHS12-SPD8ICC	HIGH SPEED AUTO TRIMMER with DLC Base (高速平缝自动切线机用内梭 DLC 加工)
KHS12-RYPICC	EMBROIDARY with DLC Base (自动切线刺绣用, 内梭 DLC 加工)
KRP457-W3ICC	ZIGZAG with DLC Base (曲折缝, 内梭 DLC 加工)
KRT842KCICC	BROTHER TWO NEEDLE with DLC Base (兄弟, 双针用, 内梭 DLC 加工)
KRT875LKICC	BROTHER TWO NEEDLE with DLC Base (兄弟, 双针用, 内梭 DLC 加工)

- * **Low friction.**
(低摩擦力)
- * **High heat resistance.**
(耐热性)
- * **High durability.**
(高耐久力)
- * **Minimal oiling.**
(可以最小给油 (微量给油))



9. ADJUSTABLE STRONG NEEDLE GUARD (护针片调整旋梭)

PATENT PENDING
(特许申请中)



Easy adjusting (简单调整)



LEADING MODELS (例如如下商品)

KRT12-5LMCV	MITSUBISHI	TWO NEEDLE
	(三菱 双针)	
KRT12-5LMKC-CIV	MITSUBISHI	TWO NEEDLE
	(三菱 双针)	
KRT872LV	BROTHER	TWO NEEDLE
	(兄弟 双针)	

- * Easy adjustable needle guard.
(简单调整护针片)
- * More than 7 times stronger needle guard protects the hook tip from needle hitting.
(比以往护针片强 7 倍的强度保护与针接触的梭尖)



SABUN INDUSTRIAL CO., LTD.
JAPAN